

Product data sheet

Specifications



Selector switch flush mounted,
Harmony XB5, plastic, black, 30mm,
long handle, 3 positions, stay put, 2
NO

XB5FJ33

Main

Range of product	Harmony XB5
Product or component type	Selector switch
Device short name	XB5F
Bezel material	Dark grey plastic
Head type	Built-in-flush
Mounting diameter	30.5 mm
Sale per indivisible quantity	1
Shape of signaling unit head	Round
Type of operator	stay put
Operator profile	Black long handle, unmarked
Operator position information	3 positions +/- 45°
Contacts type and composition	2 NO
Contact operation	Slow-break
Connections - terminals	Screw clamp terminals, $\leq 2 \times 1.5 \text{ mm}^2$ with cable end conforming to IEC 60947-1 Screw clamp terminals, $\geq 1 \times 0.22 \text{ mm}^2$ without cable end conforming to IEC 60947-1

Complementary

Height	42 mm
Width	36.6 mm
Depth	73 mm
Terminals description ISO n°1	(13-14)NO (23-24)NO
Resistance to high pressure washer	7000000 Pa at 55 °C, distance : 0.1 m
Contacts usage	Standard contacts
Positive opening	Without
Mechanical durability	1000000 cycles
Tightening torque	0.8...1.2 N.m conforming to IEC 60947-1
Shape of screw head	Cross compatible with Philips no 1 screwdriver Cross compatible with pozidriv No 1 screwdriver Slotted compatible with flat $\varnothing 4 \text{ mm}$ screwdriver Slotted compatible with flat $\varnothing 5.5 \text{ mm}$ screwdriver
Contacts material	Silver alloy (Ag/Ni)
Short-circuit protection	10 A cartridge fuse type gG conforming to IEC 60947-5-1

[Ith] conventional free air thermal current	10 A conforming to IEC 60947-5-1
[U_i] rated insulation voltage	600 V (pollution degree 3) conforming to IEC 60947-1
[U_{imp}] rated impulse withstand voltage	6 kV conforming to IEC 60947-1
[I_e] rated operational current	3 A at 240 V, AC-15, A600 conforming to IEC 60947-5-1 6 A at 120 V, AC-15, A600 conforming to IEC 60947-5-1 0.1 A at 600 V, DC-13, Q600 conforming to IEC 60947-5-1 0.27 A at 250 V, DC-13, Q600 conforming to IEC 60947-5-1 0.55 A at 125 V, DC-13, Q600 conforming to IEC 60947-5-1 1.2 A at 600 V, AC-15, A600 conforming to IEC 60947-5-1
Electrical durability	1000000 cycles, AC-15, 2 A at 230 V, operating rate <3600 cyc/h, load factor: 0.5 conforming to IEC 60947-5-1 appendix C 1000000 cycles, AC-15, 3 A at 120 V, operating rate <3600 cyc/h, load factor: 0.5 conforming to IEC 60947-5-1 appendix C 1000000 cycles, AC-15, 4 A at 24 V, operating rate <3600 cyc/h, load factor: 0.5 conforming to IEC 60947-5-1 appendix C 1000000 cycles, DC-13, 0.2 A at 110 V, operating rate <3600 cyc/h, load factor: 0.5 conforming to IEC 60947-5-1 appendix C 1000000 cycles, DC-13, 0.5 A at 24 V, operating rate <3600 cyc/h, load factor: 0.5 conforming to IEC 60947-5-1 appendix C
Electrical reliability	$\Lambda < 10\text{exp}(-6)$ at 5 V, 1 mA in clean environment conforming to IEC 60947-5-4 $\Lambda < 10\text{exp}(-8)$ at 17 V, 5 mA in clean environment conforming to IEC 60947-5-4
Device presentation	Complete product

Environment

Protective treatment	TH
Ambient air temperature for storage	-40...70 °C
Ambient air temperature for operation	-40...70 °C
Electrical shock protection class	Class II conforming to IEC 60536
IP degree of protection	IP66 conforming to IEC 60529 IP67 IP69 IP69K
Enclosure Type	UL type 4X/13
IK degree of protection	IK03 conforming to IEC 50102
Standards	IEC 60947-1 UL 508 JIS C8201-5-1 IEC 60947-5-4 IEC 60947-5-1 CSA C22.2 No 14 JIS C8201-1
Product certifications	UL listed CSA
Vibration resistance	5 gn (f= 2...500 Hz) conforming to IEC 60068-2-6
Shock resistance	30 gn (duration = 18 ms) for half sine wave acceleration conforming to IEC 60068-2-27 50 gn (duration = 11 ms) for half sine wave acceleration conforming to IEC 60068-2-27

Packing Units

Unit Type of Package 1	PCE
Number of Units in Package 1	1
Package 1 Height	5.334 cm
Package 1 Width	4.318 cm

Package 1 Length	9.144 cm
------------------	----------

Package 1 Weight	63.503 g
------------------	----------

Contractual warranty

Warranty (in months)	18
----------------------	----



Environmental Data

Schneider Electric aims to achieve Net Zero status by 2050 through supply chain partnerships, lower impact materials, and circularity via our ongoing “Use Better, Use Longer, Use Again” campaign to extend product lifetimes and recyclability.

[Environmental Data explained >](#)

[How we assess product sustainability >](#)



Environmental footprint

Total lifecycle Carbon footprint	0.7 kg CO2 eq.
Carbon footprint of the manufacturing phase [A1 to A3]	0.4 kg CO2 eq.
Carbon footprint of the distribution phase [A4]	0 kg CO2 eq.
Carbon footprint of the installation phase [A5]	0 kg CO2 eq.
Carbon footprint of the use phase [B2, B3, B4, B6]	0.2 kg CO2 eq.
Carbon footprint of the end-of-life phase [C1 to C4]	0.1 kg CO2 eq.

Use Better



Materials and Substances

Average percentage of recycled plastic content	27 %
Average percentage of recycled metal content	16 %
Packaging made with recycled cardboard	Yes
Packaging without single use plastic	Yes
EU RoHS Directive	Compliant
REACH Regulation	Free of Substances of Very High Concern above the threshold
California proposition 65	WARNING: This product can expose you to chemicals including: Di-isodecyl phthalate (DIDP), which is known to the State of California to cause birth defects or other reproductive harm. For more information go to www.P65Warnings.ca.gov

Use Longer



Lifetime extension

Repair	No
Product repair index	A

Use Again



Repack and remanufacture

End of life manual availability	End of Life Information
Take-back	No
WEEE Label	 The product must be disposed on European Union markets following specific waste collection and never end up in rubbish bins

Dimensions Drawings

Dimensions

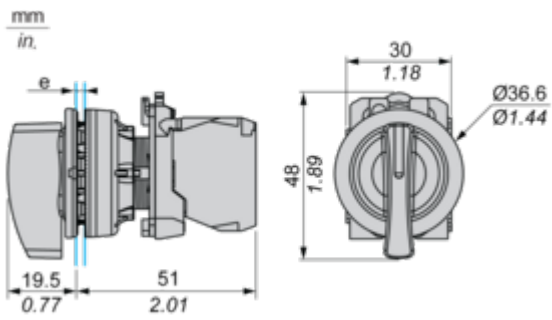

e: Clamping thickness: 1 to 6 mm / 0.04 to 0.24 in.

Mounting and Clearance

Panel Cut-out for Pushbuttons, Switches and Pilot Lights (Finished Holes, Ready for Installation)

Connection by Screw Clamp Terminals or Plug-in Connectors



(1) Diameter on finished panel or support

(2) $\text{Ø}30.75 \text{ mm}$ recommended ($\text{Ø}30.5 \text{ }_0^{+0.5}$) / $\text{Ø}1.21 \text{ in.}$ recommended ($\text{Ø}1.20 \text{ in. }_0^{+0.0196}$)

Connections	a in mm	a in in.	b in mm	b in in.
By screw clamp terminals or plug-in connector	40	1.57	40	1.57
By Faston connectors	45	1.77	40	1.57

Technical Description

Electrical Composition Corresponding to Code C3



Electrical Composition Corresponding to Code C4



Electrical Composition Corresponding to Code C5

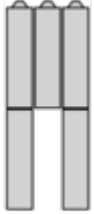

Electrical Composition Corresponding to Code C6

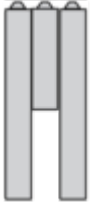

Electrical Composition Corresponding to Code C7

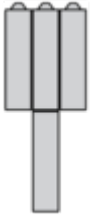

Electrical Composition Corresponding to Code C8

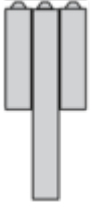

Electrical Composition Corresponding to Codes C9, C11, SF1 and SR1

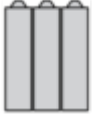

Electrical Composition Corresponding to Code C15

1 N/O

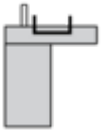

1 N/C



1 N/O + N/C or 1 N/O + N/O or 1 N/C + N/C



Legend

Single contact



Double contact



Light block



Possible location



Sequence of Contacts Fitted to 2-position Selector Switch Body

Position 315°



Push	Position	Top			
		Bottom			
	Location		Left	Centre	Right
	State		0	0	0
	Contacts	N/O	open	open	open
N/C		closed	closed	closed	

Position 45°



Push	Position	Top			
		Bottom			
	Location		Left	Centre	Right
	State		1	1	1
Contacts	N/O	closed	closed	closed	
	N/C	open	open	open	

Technical Illustration

Dimensions

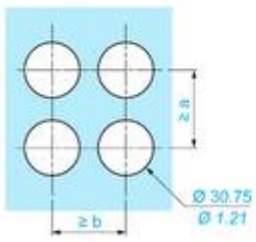
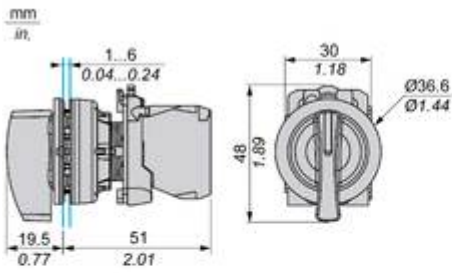

		a (mm)	a (in.)	b (mm)	b (in.)
		40	1.57	40	1.57
ZBE.....	ZBV.....				
		45	1.77	40	1.57
ZBE.....3	ZBV.....3				
		40	1.57	40	1.57
ZBE.....4	ZBV.....4				

Image of product / Alternate images

Alternative





