

# Productinformatieblad

Specificaties



## Compleet contactblok, Harmony XB4, enkel contact, met bevestigingskraag, metaal, 1 NO, compacte Push-in

ZB4BZ1015

EAN Code: 3389119037686

**Prijs: 9,40 EUR**

### Hoofd

range of product	Harmony XB4
product of component type	Volledige montage lichaam/contact
device short name	ZB4
materiaal bevestigingskraag	Zamak
verkoop per ondeelbare hoeveelheid	1
koptype	Standaard
type en samenstelling contacten	1 NO
werking contacten	Slow-break
type contactblok	Enkelvoudig
samenstelling apparaat	Bevestigingskraag Behuizing
aansluitingen - aansluitklemmen	Insteek, $\leq 2 \times 1,5 \text{ mm}^2$ met kabeluiteinde met aansluitflensbus In overeenstemming met IEC 60947-1 Insteek, $\geq 1 \times 0,34 \text{ mm}^2$ zonder draadeinddop In overeenstemming met IEC 60947-1

### Complementair

CAD totale breedte	46,2 mm
CAD totale hoogte	27,6 mm
CAD totale diepte	30 mm
beschrijving klemmen ISO n°1	(13-14)NO
gewicht product	0,043 kg
contact gebruik	Standaardcontacten
positieve opening	Zonder
bedrijfstraject	2,05 mm (normaal open elektrische status wijzigen) 4,3 mm (totale reis)
bedieningskracht	2,45 N normaal open elektrische status wijzigen
mechanical durability	10000000 cycles
contact materiaal	Zilverlegering (Ag/Ni)
kortsluitbeveiliging	10 A smeltpatroon type gG In overeenstemming met IEC 60947-5-1
Ith conventionele thermische stroom in vrije lucht	10 A In overeenstemming met IEC 60947-5-1
Ui nom isolatiespanning	300 V (vervuilingsgraad) 3) In overeenstemming met IEC 60947-1

De weergegeven prijs is de adviesprijs in euro excl. BTW. Deze kan onderhevig zijn aan korting. Neem contact op met uw lokale distributeur of detailhandel voor de daadwerkelijke prijs

<b>Uimp nom. schokgolfspanning</b>	4 kV In overeenstemming met IEC 60947-1
<b>le nom. bedrijfstrom</b>	6 A om 120 V, AC-15, A300 In overeenstemming met IEC 60947-5-1 3 A om 240 V, AC-15, A300 In overeenstemming met IEC 60947-5-1 0,55 A om 125 V, DC-13, Q300 In overeenstemming met IEC 60947-5-1 0,27 A om 250 V, DC-13, Q300 In overeenstemming met IEC 60947-5-1
<b>product presentatie</b>	Basis sub-eenheden

## Omgeving

<b>beschermende behandeling</b>	TH
<b>ambient air temperature for storage</b>	-40...70 °C
<b>omgevingstemperatuur voor werking</b>	-40...70 °C
<b>IP beschermingsgraad</b>	IP20 In overeenstemming met IEC 60529
<b>standards</b>	IEC 60947-1 IEC 60947-5-1 IEC 60947-5-4 IEC 60947-5-5 UL 60947-1 UL 60947-5-1 UL 60947-5-5 UL 1059 UL 486E CSA C22.2 Nr 60947-1 CSA C22.2 Nr 60947-5-1 CSA C22.2 Nr. 158 CSA C22.2 Nr 65 IACS E10
<b>product certifications</b>	EAC ECEE CB-regeling CCC UL CSA
<b>trilling bestendigheid</b>	5 gn (f= 10...500 Hz) In overeenstemming met IEC 60068-2-6 25 mm piek-piek (f= 2...10 Hz) In overeenstemming met IEC 60068-2-6
<b>schokbestendigheid</b>	25 gn (duur = 6 ms) voor 1000 schokken op elke as In overeenstemming met IEC 60068-2-27 30 gn (duur = 18 ms) voor halve sinusgolf versnelling In overeenstemming met IEC 60068-2-27 50 gn (duur = 11 ms) voor halve sinusgolf versnelling In overeenstemming met IEC 60068-2-27

## Verpakkingseenheid

<b>Eenheidstype van verpakking 1</b>	PCE
<b>Aantal eenheden in verpakking 1</b>	1
<b>verpakking 1 hoogte</b>	3,400 cm
<b>verpakking 1 breedte</b>	3,400 cm
<b>verpakking 1 lengte</b>	5,400 cm
<b>verpakking_1_gewicht</b>	52,000 g
<b>Eenheidstype van verpakking 2</b>	S03
<b>Aantal eenheden in verpakking 2</b>	200
<b>verpakking 2 hoogte</b>	30,000 cm
<b>verpakking 2 breedte</b>	30,000 cm
<b>verpakking 2 lengte</b>	40,000 cm
<b>verpakking 2 gewicht</b>	10,845 kg

# contractuele waarborg

---

Garantie (in maanden)

18

Schneider Electric wil tegen 2050 de Net Zero-status hebben bereikt via partnerschappen in de toeleveringsketen, materialen met een lagere impact en circulariteit via onze doorlopende campagne "Use Better, Use Longer, Use Again" om de levensduur van producten en de recycleerbaarheid te verlengen.

[Uitleg van Environmental Data >](#)

[Hoe evalueren we de duurzaamheid van producten? >](#)

### Milieuoetafdruk

Totale levenscyclus ecologische voetafdruk	0.5 kg CO2 eq.
Koolstofvoetafdruk van de fabricagefase [A1–A3]	0.4 kg CO2 eq.
Koolstofvoetafdruk van de distributiefase [A4]	0 kg CO2 eq.
Koolstofvoetafdruk van de installatiefase [A5]	0 kg CO2 eq.
Koolstofvoetafdruk van de gebruiksfase [B2, B3, B4, B6]	0 kg CO2 eq.
Koolstofvoetafdruk van de einde-levensfase [C1–C4]	0.1 kg CO2 eq.

## Use Better

### Materialen en verpakking

Gemiddeld percentage gerecycleerde kunststof	23 %
Gemiddeld percentage gerecycleerd metaal	16 %
Pakket met gerecycleerd karton	Ja
Verpakkingen zonder kunststof	Ja
RoHS-richtlijn van de EU	<a href="#">Conform</a>
REACH-verordening	<a href="#">Referentie bevat geen SVHC boven drempelwaarde</a>

## Use Longer

### Levensduurverlenging

Reparatie	Nee
-----------	-----

## Use Again

### Herverpakken en herfabriceren

Circulair Profiel	<a href="#">Informatie over einde levensduur</a>
Terugname	Ja
WEEE-label	 Het product moet op markten van de Europese Unie worden afgevoerd volgens specifieke afvalinzamelingsregels en mag nooit in een gewone vuilnisbak terecht komen.

Dimensions Drawings

Dimensions

---

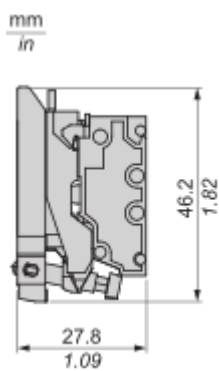

Mounting and Clearance

Mounting

---

Mounting and Unmounting



Panel cut-out Dimension

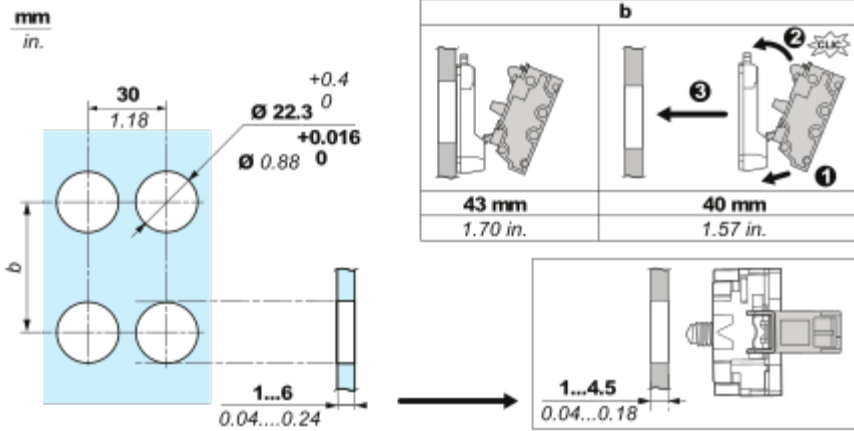

Connections and Schema

Wiring

Wiring and Unwiring



mm	8
in.	0.32
mm <sup>2</sup>	0.34...1.5
AWG	22...16



mm	8	8	8
in.	0.32	0.32	0.32
mm <sup>2</sup>	0.34...1.5	0.34...1	0.34...1.5
AWG	22...16	22...18	22...16



Technical Illustration

Dimensions

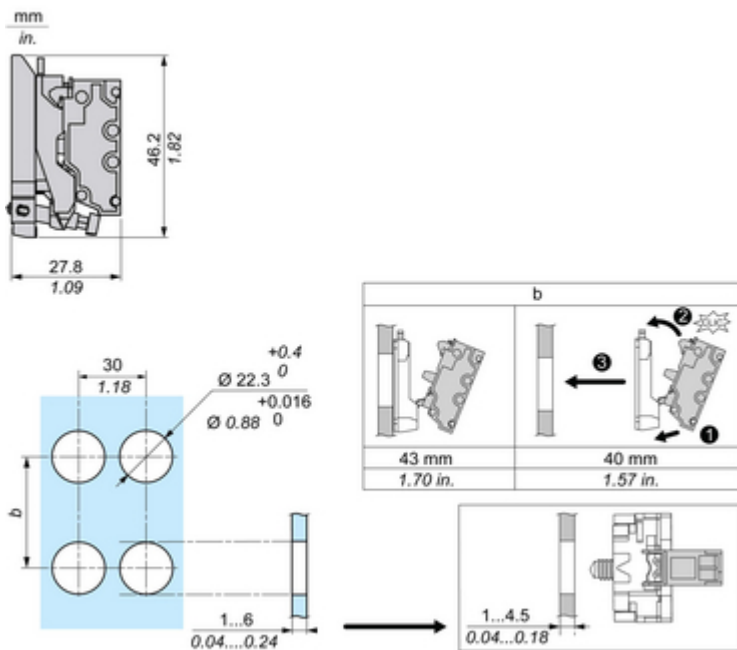

Technical Illustration

Wiring diagram



mm	8
in.	0.32
mm <sup>2</sup>	0.34...1.5
AWG	22...18

Max	0.8 mm
	0.031 in.
	2.4 mm
	0.09...0.157 in.

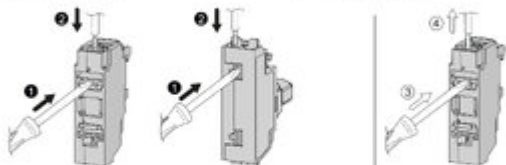

mm	8	8	8
in.	0.32	0.32	0.32
mm <sup>2</sup>	0.34...1.5	0.34...1	0.34...1.5
AWG	22...18	22...18	22...18

Max	1.9 mm
	0.07 in.
	2.4 mm
	0.09 in.

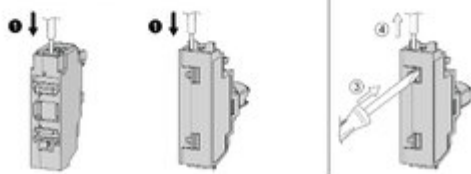

Offer Marketing Illustration

Product benefits / Features

---

### Technical Benefits

#### Harmony XB4/XB5 Compact Push-in blocks

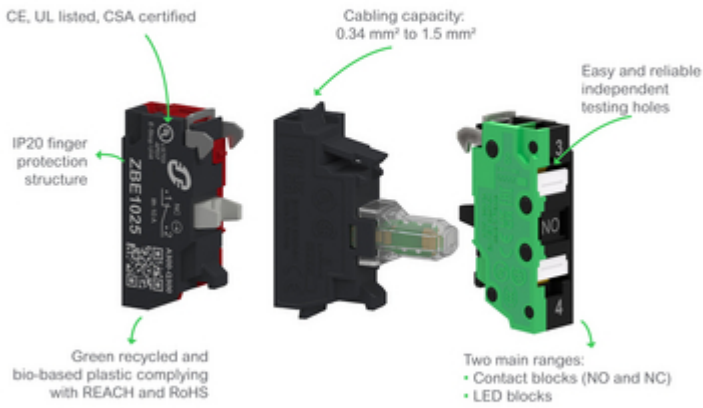

Offer Marketing Illustration

Product benefits / Features

---

**Features**  
Harmony XB4/XB5 Compact Push-in blocks

-  37% thinner than a standard block
-  Installation costs saved through reduced wiring time and effort
-  Fully compatible with current Harmony offer
-  Available as single block, sub-assemblies and complete units (both plastic and metal ranges)
-  Simplified inventory management

Offer Marketing Illustration



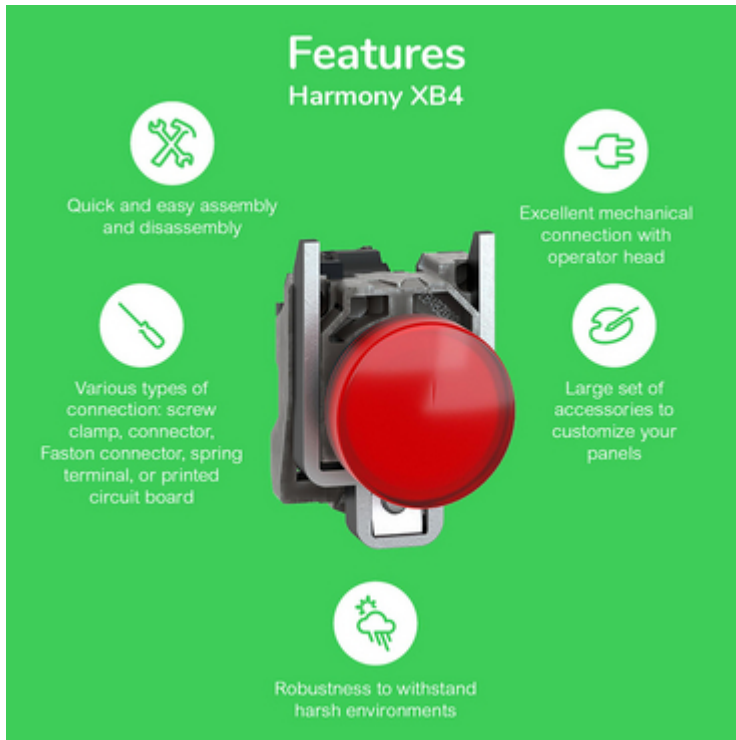

Product benefits / Features

---



The infographic features a central image of a red Schneider XB4 terminal block. Surrounding this central image are five circular icons, each with a corresponding text description of a feature. The background is a solid green color.

### Features Harmony XB4

-  Quick and easy assembly and disassembly
-  Various types of connection: screw clamp, connector, Faston connector, spring terminal, or printed circuit board
-  Excellent mechanical connection with operator head
-  Large set of accessories to customize your panels
-  Robustness to withstand harsh environments

Offer Marketing Illustration

Product benefits / Features

---

## Technical Benefits

### Harmony XB4

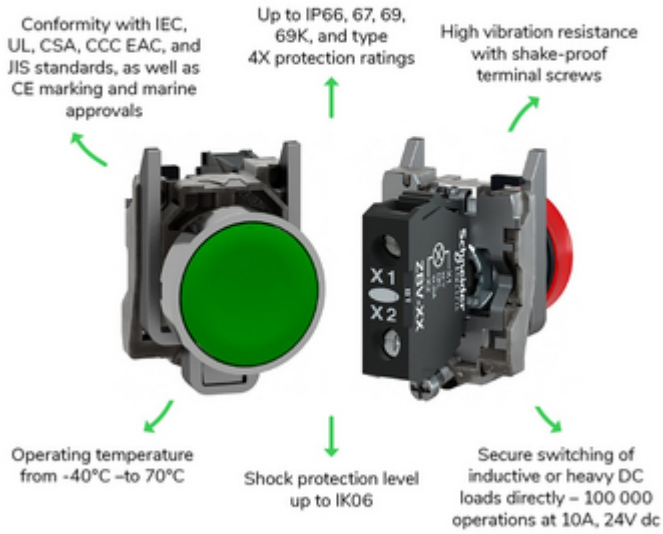

Image of product / Alternate images

Alternative

---

