

## Data Sheet | Item Number: 264-186

2-conductor terminal strip; without push-buttons; suitable for Ex e II applications; with snap-in mounting feet; 6-pole; for plate thickness 0.6 - 1.2 mm; Fixing hole 3.5 mm Ø; 2.5 mm<sup>2</sup>; CAGE CLAMP®; 2,50 mm<sup>2</sup>; light gray

<https://www.wago.com/264-186>



Color: ■ light gray

Similar to illustration

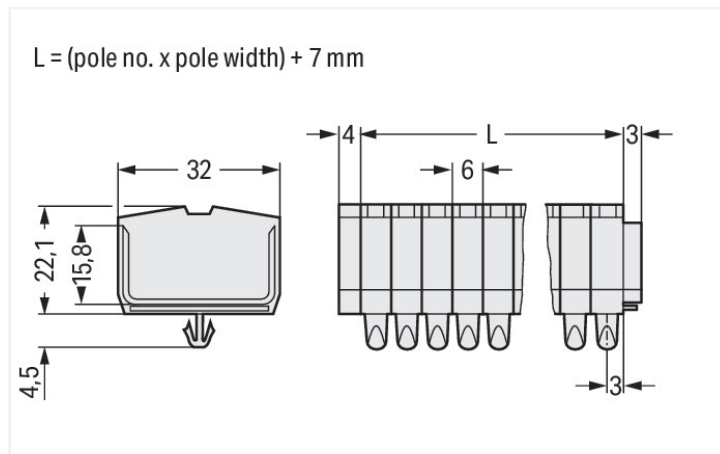

### Through terminal block, 264 Series, operating tool

Our through terminal block (item number 264-186) makes connections quick and easy. Conductors should only be connected to this through terminal block if their strip length is between 8 and 9 mm. Our mini rail-mount terminal blocks are perfect for working in tight spaces thanks to their compact design. With various mounting and actuation options, they offer complete flexibility. This product features conductor terminals and utilizes CAGE CLAMP®. Our proven universal connection known as CAGE CLAMP® leads the way when it comes to connection technology and electrical interconnections. Dimensions: (43 x 32 x 22.1) mm (width x height x depth). This through terminal block is suitable for conductor cross sections ranging from 0.08 mm<sup>2</sup> to 2.5 mm<sup>2</sup>.

This mini rail-mount terminal block is operated with an operating tool.

### Electrical data

#### Ex information

Reference to hazardous areas	See "Downloads – Documentation – Additional Information: Technical Section; Technical Explanations"
Rated voltage EN (Ex e II)	690 V
Rated current (Ex e II)	23 A

#### General information

Wiring direction	Front-entry wiring
------------------	--------------------

### Connection Data

Clamping units	12
Total number of potentials	6
Number of levels	1

#### Connection 1

Connection technology	CAGE CLAMP®
Actuation type	Operating tool
Connectable conductor materials	Copper
Solid conductor	0.08 ... 2.5 mm <sup>2</sup> / 28 ... 12 AWG
Fine-stranded conductor	0.08 ... 2.5 mm <sup>2</sup> / 28 ... 12 AWG
Note (conductor cross-section)	12 AWG: THHN, THWN
Strip length	8 ... 9 mm / 0.31 ... 0.35 inches

### Connection 1

Pole number	6
Wiring direction	Front-entry wiring

### Physical data

Width	43 mm / 1.693 inches
Height	32 mm / 1.26 inches
Height from the surface	22.1 mm / 0.87 inches
Depth	22.1 mm / 0.87 inches
Module width	6 mm / 0.236 inches

### Mechanical data

Design	horizontal type
Mounting type	Snap-in foot
Marking level	Center marking

### Material data

Note (material data)	<a href="#">Information on material specifications can be found here</a>
Color	light gray
Material group	I
Insulation material (main housing)	Polyamide (PA66)
Flammability class per UL94	V0
Fire load	0.506 MJ
Halogen-free	Yes
Weight	25.9 g

### Commercial data

Product Group	9 (Std Chassis Mt Blocks)
PU (SPU)	50 pcs
Packaging type	Box
Country of origin	DE
GTIN	4044918423298
Customs tariff number	85369010000

### Product Classification

UNSPSC	39121410
eCl@ss 10.0	27-14-11-06
eCl@ss 9.0	27-14-11-06
ETIM 9.0	EC001284
ETIM 10.0	EC001284
ECCN	NO US CLASSIFICATION

**Environmental Product Compliance**

RoHS Compliance Status	Compliant, No Exemption
------------------------	-------------------------

**Approvals / Certificates**

**General approvals** **Declarations of conformity and manufacturer's declarations**



Approval	Standard	Certificate Name
CSA DEKRA Certification B.V.	C22.2	70010891
UR Underwriters Laboratories Inc.	UL 1059	E45172

Approval	Standard	Certificate Name
ATEX-Attestation of Conformity WAGO GmbH & Co. KG	-	-

**Approvals for marine applications**



Approval	Standard	Certificate Name
LR Lloyds Register	IEC 60998	LR22173030TA

**Approvals for hazardous areas**



Approval	Standard	Certificate Name
AEx UL International Germany GmbH c/o Physikalisch Technische Bundesanstalt	UL 60079	E185892 (AEx eb IIC resp. Ex eb IIC)
ATEX Physikalisch Technische Bundesanstalt (PTB)	EN 60079	PTB 98 ATEX 3129 U (II 2 G Ex eb IIC Gb bzw. I M 2 Ex eb I Mb)
CCC CQST/CNEx	GB/T 3836.3	2020312313000187 (Ex eb IIC Gb, Ex eb I Mb)
IECEX Physikalisch Technische Bundesanstalt (PTB)	IEC 60079	IECEX PTB 04.0003U (Ex e IIC Gb and Ex eb I Mb)
INMETRO TÜV Rheinland do Brasil Ltda.	IEC 60079	TÜV 12.1299 U

**Downloads**

**Environmental Product Compliance**

Compliance Search
Environmental Product Compliance 264-186

## Documentation

Bid Text			
264-186	19.02.2019	xml 3.28 KB	<a href="#">↓</a>
264-186	14.06.2017	doc 25.00 KB	<a href="#">↓</a>

## CAD/CAE-Data

CAD data	CAE data
2D/3D Models 264-186 <a href="#">↓</a>	EPLAN Data Portal 264-186 <a href="#">↓</a>
	WSCAD Universe 264-186 <a href="#">↓</a>
	ZUKEN Portal 264-186 <a href="#">↓</a>

## 1 Compatible Products

### 1.1 Optional Accessories

#### 1.1.1 DIN-rail

##### 1.1.1.1 Mounting accessories



**Item No.: 210-154**

Aluminum carrier rail; 1000 mm long; 18 mm wide; 7 mm high; silver-colored

### 1.1.2 Ferrule

#### 1.1.2.1 Ferrule



**Item No.: 216-131**

Ferrule; Sleeve for 0.25 mm<sup>2</sup> / AWG 24; uninsulated; electro-tin plated; silver-colored



**Item No.: 216-201**

Ferrule; Sleeve for 0.5 mm<sup>2</sup> / 20 AWG; insulated; electro-tin plated; electrolytic copper; acc. to DIN 46228, Part 4/09.90; white



**Item No.: 216-101**

Ferrule; Sleeve for 0.5 mm<sup>2</sup> / AWG 22; uninsulated; electro-tin plated; silver-colored



**Item No.: 216-202**

Ferrule; Sleeve for 0.75 mm<sup>2</sup> / 18 AWG; insulated; electro-tin plated; gray



**Item No.: 216-102**

Ferrule; Sleeve for 0.75 mm<sup>2</sup> / AWG 20; uninsulated; electro-tin plated; silver-colored



**Item No.: 216-203**

Ferrule; Sleeve for 1 mm<sup>2</sup> / AWG 18; insulated; electro-tin plated; red



**Item No.: 216-103**

Ferrule; Sleeve for 1 mm<sup>2</sup> / AWG 18; uninsulated; electro-tin plated



**Item No.: 216-204**

Ferrule; Sleeve for 1.5 mm<sup>2</sup> / AWG 16; insulated; electro-tin plated; black



**Item No.: 216-104**

Ferrule; Sleeve for 1.5 mm<sup>2</sup> / AWG 16; uninsulated; electro-tin plated; silver-colored



**Item No.: 216-205**

Ferrule; Sleeve for 2.08 mm<sup>2</sup> / AWG 14; insulated; electro-tin plated; yellow



**Item No.: 216-206**

Ferrule; Sleeve for 2.5 mm<sup>2</sup> / AWG 14; insulated; electro-tin plated; blue



**Item No.: 216-106**

Ferrule; Sleeve for 2.5 mm<sup>2</sup> / AWG 14; uninsulated; electro-tin plated; silver-colored

### 1.1.3 Installation

#### 1.1.3.1 Cover



**Item No.:** [709-153](#)

Cover; Type 1; suitable for cover carrier, type 1; 1 m long; transparent

#### 1.1.3.2 Cover carrier



**Item No.:** [709-167](#)

Cover carrier; Type 1; incl. fixing/retaining screws and knurled nut; suitable for 279 to 282 and 880 Series rail-mounted terminal blocks; suitable for 264 Series miniature rail-mounted terminal blocks; suitable for 270 Series sensor and actuator terminal blocks; gray

### 1.1.4 Jumper

#### 1.1.4.1 Jumper



**Item No.:** [281-492](#)

Jumper; 2-way; insulated; gray



**Item No.:** [264-402](#)

Jumper; for conductor entry; 2-way; insulated; gray

### 1.1.5 Marking

#### 1.1.5.1 Marker

**Item No.:** [2009-145/000-006](#)

Mini-WSB Inline; for Smart Printer; 1700 pieces on roll; stretchable 5 - 5.2 mm; plain; snap-on type; blue

**Item No.:** [2009-145/000-007](#)

Mini-WSB Inline; for Smart Printer; 1700 pieces on roll; stretchable 5 - 5.2 mm; plain; snap-on type; gray

**Item No.:** [2009-145/000-023](#)

Mini-WSB Inline; for Smart Printer; 1700 pieces on roll; stretchable 5 - 5.2 mm; plain; snap-on type; green

**Item No.:** [2009-145/000-012](#)

Mini-WSB Inline; for Smart Printer; 1700 pieces on roll; stretchable 5 - 5.2 mm; plain; snap-on type; orange

**Item No.:** [2009-145/000-005](#)

Mini-WSB Inline; for Smart Printer; 1700 pieces on roll; stretchable 5 - 5.2 mm; plain; snap-on type; red

**Item No.:** [2009-145/000-024](#)

Mini-WSB Inline; for Smart Printer; 1700 pieces on roll; stretchable 5 - 5.2 mm; plain; snap-on type; violet

**Item No.:** [2009-145](#)

Mini-WSB Inline; for Smart Printer; 1700 pieces on roll; stretchable 5 - 5.2 mm; plain; snap-on type; white

**Item No.:** [2009-145/000-002](#)

Mini-WSB Inline; for Smart Printer; 1700 pieces on roll; stretchable 5 - 5.2 mm; plain; snap-on type; yellow



**Item No.:** [248-501/000-006](#)

Mini-WSB marking card; as card; not stretchable; plain; snap-on type; blue

**Item No.:** [248-501/000-007](#)

Mini-WSB marking card; as card; not stretchable; plain; snap-on type; gray

**Item No.:** [248-501/000-023](#)

Mini-WSB marking card; as card; not stretchable; plain; snap-on type; green

**Item No.:** [248-501/000-017](#)

Mini-WSB marking card; as card; not stretchable; plain; snap-on type; light green



**Item No.:** [248-501/000-012](#)

Mini-WSB marking card; as card; not stretchable; plain; snap-on type; orange

**Item No.:** [248-501/000-005](#)

Mini-WSB marking card; as card; not stretchable; plain; snap-on type; red

**Item No.:** [248-501/000-024](#)

Mini-WSB marking card; as card; not stretchable; plain; snap-on type; violet

**Item No.:** [248-501](#)

Mini-WSB marking card; as card; not stretchable; plain; snap-on type; white



**Item No.:** [248-501/000-002](#)

Mini-WSB marking card; as card; not stretchable; plain; snap-on type; yellow

1.1.6 Tool

1.1.6.1 Operating tool



**Item No.: 210-658**

Operating tool; Blade: 3.5 x 0.5 mm; with a partially insulated shaft; angled; short; multicoloured



**Item No.: 210-720**

Operating tool; Blade: 3.5 x 0.5 mm; with a partially insulated shaft; multicoloured



**Item No.: 210-657**

Operating tool; Blade: 3.5 x 0.5 mm; with a partially insulated shaft; short; multicoloured



**Item No.: 209-130**

Operating tool; made of insulating material; 1-way; for 264 Series (1-/2-way), 280, 281 Series (up to 3-way); natural

Installation Notes

Installation

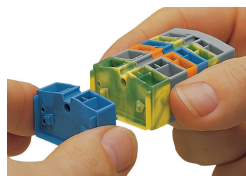

Assembling modular terminal blocks into terminal strips.

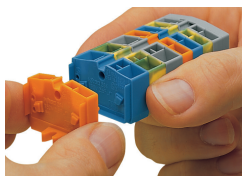

Mounting an "end terminal block" with mounting flange.

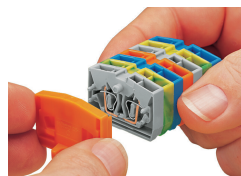

Mounting an end plate.

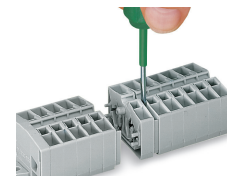

Removing a terminal block.

Conductor termination



**CAGE CLAMP® connection**

Inserting a conductor.  
With ferruled conductors, it is necessary to use a terminal block one size smaller than the conductor's nominal cross-section.

Commoning

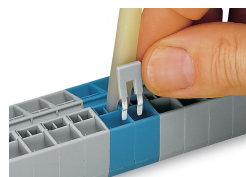

Commoning with comb-style jumper bar.

Testing

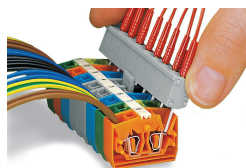

Testing by touch contact to the CAGE CLAMP® spring (limited to 0.5 A and 48 V test voltage) – test pins are not protected against accidental contact.

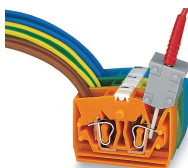

Testing via CAGE CLAMP® on the current bar (max. nominal current: 6 A). CAGE CLAMP® clamps individual test contacts. The maximum test voltage is 400 V.

Marking



Marking via Mini-WSB Quick Marking System.