

Surface mounted inlet

Part number: 385



MENNEKES
Elektrotechnik GmbH & Co. KG

Aloys-Mennekes-Straße 1
57399 Kirchhundem
GERMANY

www.MENNEKES.org

Product Description

- screw connection technology
- external fixing
- 10° inclination

Technical Details

Surface mounted inlet	385
Ampere	32A
Number of poles	4p
Clock position	6h
Nominal voltage AC	400V
Nominal frequency	50 - 60 Hz
Protection type IP	IP44
Contact carrier	standard
Connection	screw terminals
Tightening torque connection terminal	PZ2, slot
Phase inverter	without phase inverter
Pilot contact	without pilot contact
Flange dimensions	75 x 90 mm
Hole spacings	45 x 78 mm
Insertion direction	angled
Inclination	10°
Type of mounting	external fixing
Military version	no
Protection cap	without protection cap
Tightening torque connection terminal for cable cross-section 2,5 - 4,0 mm ²	0.8 Nm
Tightening torque connection terminal for cable cross-section 6,0 mm ²	1.2 Nm
Recommended wire end treatment for supply cable connection terminal	ferrule square gasproof crimped
Strip length conductor	12 - 17 mm
Conductor cross-section min.	2.5 mm ²
Conductor cross-section max.	6 mm ²

Surface mounted inlet	385
Weight (net)	245 g
Packaging unit	10 Stück
Quantity per pallet	660 Stück
EAN / identification number	4015394002840

Permissible ambient conditions

	Min.	Max.
Permanent ambient temperature	-25 °C	40 °C
Average temperature over 24 hours		35 °C

Material properties

Housing	PA6 red [similar RAL 3013]
---------	----------------------------

Material resistance

The material resistance overview can be found on the website in the section “Knowledge” - “Product knowledge” - “Materials”.

Material and enviromental properties

RoHS 2011/65/EU incl. 2015/863/EU	✓
POP regulation (EU) 2019/1021	✓

Regulations and Standards

Norm	DIN EN IEC 60309-2
Declaration of Conformity	CE
Test label	VDE, EAC, CQC

Dimensional Drawing

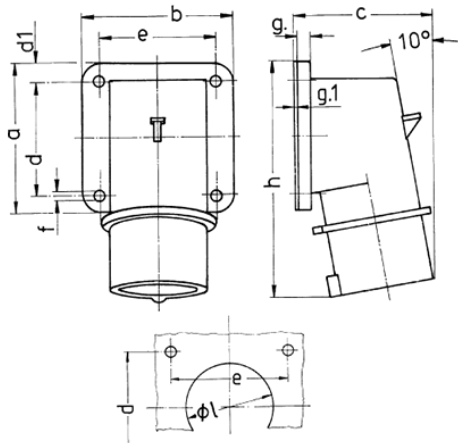

Drawing	Amp.	16		32				
		Poles		4	5	3	4	5
2 MB 73								
Dim. in mm	a	85	85	75	75	75		
	b	85	85	90	90	90		
	c	75	79	87	87	90		
	d	64	64	45	45	45		
	d1	10	10	13	13	13		
	e	64	64	78	78	78		
	f	5.5	5.5	5.5	5.5	5.5		
	g.	6	6	6	6	6		
	g.1	2	2	2	2	2		
	h	129	129	137	137	138		
	l	50	50	55	55	55		
	Terminal for cond. cross section (mm ²) min.-max.	1	1	2.5	2.5	2.5		
		-2.5	-2.5	-6	-6	-6		