

Wall mounted inlet

Part number: 340



MENNEKES
Elektrotechnik GmbH & Co. KG

Aloys-Mennekes-Straße 1
57399 Kirchhundem
GERMANY

www.MENNEKES.org

Product Description

- screw connection technology
- internal fixing
- 25° inclination
- enclosure base can be turned 180°
- enclosure base with stamped recess for quick cutting out
- cable entry also possible on the back side

Technical Details

Wall mounted inlet	340
Ampere	16A
Number of poles	5p
Clock position	4h
Nominal voltage AC	110V
Nominal frequency	50 - 60 Hz
Protection type IP	IP44
Contact carrier	standard
Connection	screw terminals
Tightening torque connection terminal	PZ2, slot
Tightening torque external screws	PZ2, slot
Phase inverter	without phase inverter
Pilot contact	without pilot contact
Cable entry at the top	1 x M20
Cable entry at the bottom	1 x M20 (blind)
Blind cable entry at the rear	yes
Enclosure base can be turned 180°	yes
Insertion direction	angled
Inclination	25°
Type of mounting	internal fixing
Military version	no
Protection cap	without protection cap
Tightening torque connection terminal for cable cross-section 1,0 - 1,5 mm ²	0.6 Nm
Tightening torque connection terminal for cable cross-section 2,5 - 4,0 mm ²	0.8 Nm

Wall mounted inlet	340
Recommended wire end treatment for supply cable connection terminal	ferrule square gasproof crimped
Strip length conductor	8 - 10 mm
Conductor cross-section min.	1 mm ²
Conductor cross-section max.	2.5 mm ²
Weight (net)	246 g
Packaging unit	10 Stück
Quantity per pallet	660 Stück
EAN / identification number	4015394002444

Permissible ambient conditions		
	Min.	Max.
Permanent ambient temperature	-25 °C	40 °C
Average temperature over 24 hours		35 °C

Material properties	
Base	PA6 light grey [similar RAL 7035]
Upper part	PA6 yellow [similar RAL 1021]
External screws	galvanised steel

Material resistance

The material resistance overview can be found on the website in the section "Knowledge" - "Product knowledge" - "Materials".

Material and environmental properties	
RoHS 2011/65/EU incl. 2015/863/EU	✓
POP regulation (EU) 2019/1021	✓

Regulations and Standards

Norm	DIN EN IEC 60309-2
Declaration of Conformity	CE
Test label	EAC, CQC

Dimensional Drawing

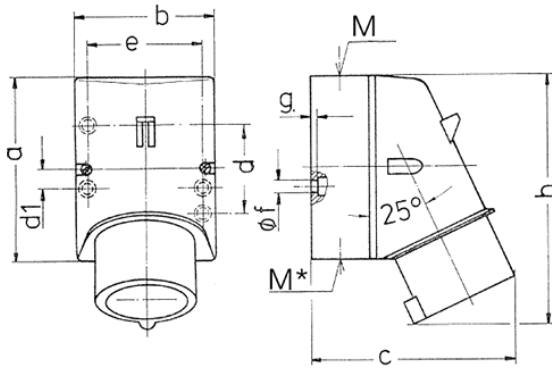

Drawing	Amp. Poles	16			32		
		3	4	5	3	4	5
2 MB 32							
Dim. in mm	a	87	100	100	128	128	128
	b	64	75	75	84	84	84
	c	93	106	110	133	133	135
	d	40	—	—	—	—	—
	d1	—	10.5	10.5	11	11	11
	e	50.5	59	59	68	68	68
	f	4,5	5	5	5.3	5.3	5.3
	g	4	4	4	4	4	4
	h	122	133	135	169	169	170
	M	20	20	20	32	32	32
	M*	1x20 (blind) to be cut out			2x25 (blind) to be cut out		
	Max. cable diam. (mm)	15	15	15	18/25	18/25	18/25
	Terminal for cond. cross section (mm ²) min.-max.	1	1	1	2.5	2.5	2.5
		-2.5	-2.5	-2.5	-6	-6	-6