

## Contactstop PowerTOP®

Bestelnr. 3832

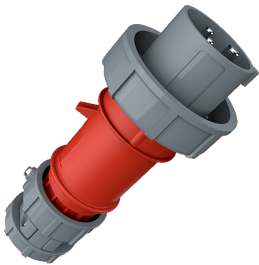

- schroefklemmen
- hittebestendig binnenwerk
- vernikkelde contacten
- wartel en buitenliggende trekontlasting

### Technische informatie

Ampère	32 A
Polen	3 p
Voltage	400 V
Uurstand	9 h
Hertz	50-60 Hz
Aansluittechniek	schroefklemmen
Contacten	hittebestendig binnenwerk, vernikkelde contacten
Beschermingsgraad	IP 67
Gewicht	307 g
Certificeringen	EAC, CQC

### Tekeningen

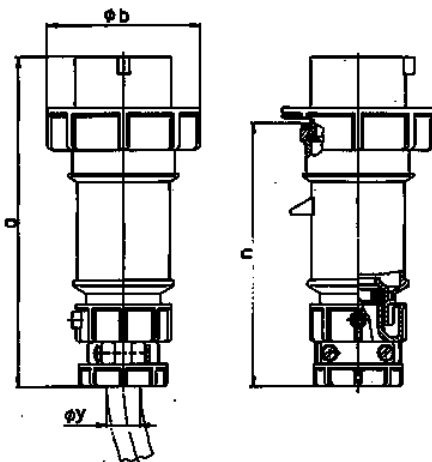

Tekening 2 MB 171	Amp. Polen	16			32		
		3	4	5	3	4	5
<b>Maten in mm</b>	<b>a</b>	162	172	186	199	199	213
	<b>b</b>	71	79	89	95	95	102
	<b>n</b>	129	139	152	157	157	172
	<b>y</b>	19	19	22	24,5	24,5	28,5
<b>Kabelaansluiting</b>		1	1	1	2,5	2,5	2,5
<b>van/tot mm<sup>2</sup></b>		-2,5	-2,5	-2,5	-6	-6	-6