

Data Sheet | Item Number: 294-4052

Lighting connector; push-button, external; without ground contact; 2-pole; Lighting side: for solid conductors; Inst. side: for all conductor types; max. 2.5 mm²; Surrounding air temperature: max 85°C (T85); white



<https://www.wago.com/294-4052>



Color: ■ white

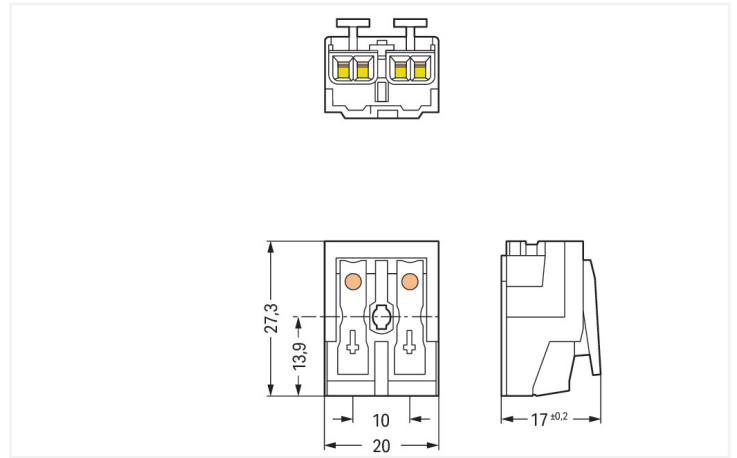

Dimensions in mm

Field-wiring terminal block, 294 Series, Push-in CAGE CLAMP®

Quick and easy connections are guaranteed with this field-wiring terminal block (item number 294-4052). Strip lengths must be between 8 and 9 mm when connecting conductors to this field-wiring terminal block. This product incorporates four conductor terminals and utilizes Push-in CAGE CLAMP® and PUSH WIRE®. Push-in CAGE CLAMP® connection technology is ideal for connecting all conductor types. Solid and fine-stranded conductors with ferrules can be plugged in without needing to use any tools—all thanks to its pluggable design. Our trusted PUSH WIRE® connection offers the fastest method for clamping conductors. It utilizes the conductor's stiffness to overcome the clamping spring's contact force. The item's dimensions are (20 x 17 x 27.3) mm (width x height x depth). Depending on the type of conductor, this field-wiring terminal block is designed for conductor cross sections ranging from 0.5 mm² to 2.5 mm² on one side and for conductor cross sections from 0.5 mm² to 2.5 mm² on the other side as well as conductor cross sections from 0.5 mm² to 1.5 mm² and from 0.5 mm² to 0.75 mm².

The contact surface is coated with tin.

Electrical data

Ratings per	IEC/EN 60998-1		
Overvoltage category	III	III	II
Pollution degree	3	2	2
Nominal voltage	-	-	500 V
Rated impulse withstand voltage	-	-	4 kV
Rated current	-	-	24 A

Ratings per IEC/EN – Notes

Ratings (note)	Connection points
----------------	-------------------

Ratings per	IEC/EN 60998-2-2		
Overvoltage category	III	III	II
Pollution degree	3	2	2
Nominal voltage	-	-	500 V
Rated impulse withstand voltage	-	-	4 kV
Rated current	-	-	24 A

General information

Wiring direction	Side-entry wiring
------------------	-------------------

Connection Data

Clamping units	10
Total number of potentials	2
Number of connection types	4
PE function	without PE contact

Connection 1

Connection type	External 1
Connection technology	Push-in CAGE CLAMP®
Number of connection points	2
Actuation type	Push-button
Connectable conductor materials	Copper
Solid conductor	0.5 ... 2.5 mm ² / 18 ... 12 AWG
Solid conductor; push-in termination	0.5 ... 2.5 mm ² / 18 ... 12 AWG
Stranded conductor	0.5 ... 2.5 mm ² / 18 ... 14 AWG
Fine-stranded conductor	0.5 ... 2.5 mm ² / 18 ... 14 AWG
Fine-stranded conductor; with insulated ferrule	0.5 ... 1.5 mm ² / 18 ... 16 AWG
Fine-stranded conductor; with uninsulated ferrule	0.5 ... 1.5 mm ² / 18 ... 16 AWG
Fine-stranded conductor; with ferrule; push-in termination	0.5 mm ² / 18 AWG
Strip length	8 ... 9 mm / 0.31 ... 0.35 inches
Pole number	2
Wiring direction	Side-entry wiring

Connection 2

Connection type	Internal 2
Connection technology	PUSH WIRE®
Number of connection points	1
Actuation type	Push-in
Solid conductor	0.5 ... 2.5 mm ² / 18 ... 14 AWG
Fine-stranded conductor; with insulated ferrule	0.5 ... 1 mm ² / 18 ... 16 AWG
Fine-stranded conductor; with uninsulated ferrule	0.5 ... 1.5 mm ² / 18 ... 14 AWG
Strip length	8 ... 9 mm / 0.31 ... 0.35 inches

Connection 3

Connection type	Internal 3
Connection technology	PUSH WIRE®
Number of connection points	1
Actuation type	Push-in
Solid conductor	0.5 ... 1.5 mm ² / 18 ... 16 AWG
Fine-stranded conductor; with insulated ferrule	0.5 ... 0.75 mm ² / 18 AWG
Fine-stranded conductor; with uninsulated ferrule	0.5 ... 1 mm ² / 18 AWG
Strip length	8 ... 9 mm / 0.31 ... 0.35 inches

Connection 4

Connection type	Internal 4
Connection technology	PUSH WIRE®
Number of connection points	1
Actuation type	Push-in
Solid conductor	0.5 ... 0.75 mm ² / 18 AWG
Strip length	8 ... 9 mm / 0.31 ... 0.35 inches

Physical data

Pin spacing	10 mm / 0.394 inches
Width	20 mm / 0.787 inches
Height	17 mm / 0.669 inches
Depth	27.3 mm / 1.075 inches

Mechanical data

Marking	1-N
Mounting type	without snap-in mounting feet

Material data

Note (material data)	Information on material specifications can be found here
Color	white
Material group	Illa
Insulation material (main housing)	Polycarbonate (PC)
Flammability class per UL94	V0
Clamping spring material	Chrome-nickel spring steel (CrNi)
Contact material	Electrolytic copper (E _{Cu})
Contact Plating	Tin
Fire load	0.121 MJ
Halogen-free	Yes
Weight	6.1 g

Environmental requirements

Temperature stability	120 °C
T marking	T85

Commercial data

Product Group	8 (Misc. Chassis Mount Blocks)
PU (SPU)	1000 pcs
Packaging type	Foil
Country of origin	CH
GTIN	4050821097792
Customs tariff number	85369010000

Product Classification

UNSPSC	39121402
eCl@ss 10.0	27-14-11-06
eCl@ss 9.0	27-14-11-06
ETIM 9.0	EC001284
ETIM 10.0	EC001284
ECCN	NO US CLASSIFICATION

Environmental Product Compliance

REACH Candidate List Substance	Perfluorobutane sulfonic acid (PFBS) and its salts
RoHS Compliance Status	Compliant, No Exemption
SCIP notification number (Austria)	5a5e424c-db60-4a3e-b813-06ce5c58e0cc
SCIP notification number (Belgium)	35e86fff-6302-4612-81e9-3c3c5da25dae
SCIP notification number (Bulgaria)	4fe6f42a-880a-4997-85e2-382c2c977a81
SCIP notification number (Czech Republic)	83626a17-565c-415a-9167-8db1cd8bbbdf
SCIP notification number (Denmark)	a6a2e812-6d98-4e34-b48e-420e3a325b5c
SCIP notification number (Finland)	9f8587f5-a86b-4cb0-939b-32e165360d80
SCIP notification number (France)	76bd005a-4b82-4071-bfc9-13c817e72197
SCIP notification number (Germany)	9468f96c-bec1-4c33-a795-c35969f5ed05
SCIP notification number (Hungary)	884521a0-36c6-4bf9-9daf-bc1f56d58fbf
SCIP notification number (Italy)	f5f2aeb7-16a9-4a0d-96bd-de5de41cb4b3
SCIP notification number (Netherlands)	4bfe47c4-fb43-48ac-9a57-2a38824aff2e
SCIP notification number (Poland)	3bdc64d8-69ae-4f6f-ba2f-22ad93a9ac07

Environmental Product Compliance

SCIP notification number (Romania)	4f420822-6ea7-4409-a7cd-d3a422728293
SCIP notification number (Sweden)	d2b1e3f8-9b1e-4ab8-8aa1-c63b7df88fd3

Approvals / Certificates

General approvals **Declarations of conformity and manufacturer's declarations**



Approval	Standard	Certificate Name
ENEC 05 DEKRA Certification B.V.	EN 60998	2128791.01

Approval	Standard	Certificate Name
EU-Declaration of Conformity WAGO GmbH & Co. KG	-	-
UK-Declaration of Conformity WAGO GmbH & Co. KG	-	-

Downloads

Environmental Product Compliance

Compliance Search
Environmental Product Compliance 294-4052 ↓

Documentation

Bid Text			
294-4052	13.06.2017	doc 27.00 KB	↓
294-4052	19.02.2019	xml 5.57 KB	↓

CAD/CAE-Data

CAD data
2D/3D Models 294-4052 ↓

CAE data
WSCAD Universe 294-4052 ↓
ZUKEN Portal 294-4052 ↓

1 Compatible Products

1.1 Optional Accessories

1.1.1 Strain relief

1.1.1.1 Strain relief



Item No.: 294-370

Strain relief; for 294 Series; with snap-in mounting feet; white

Item No.: 294-375

Strain relief; for 294 Series; without snap-in mounting feet; white

1.1.1.2 Strain relief plate



Item No.: 294-364

Strain relief plate; for 294 Series; for multi-core cables; 3- to 5-pole; with secured clamp; white

Item No.: 294-384

Strain relief plate; for 294 Series; for single strands; 3- to 5-pole; with secured clamp; white

1.1.2 Tool

1.1.2.2 Operating tool



Item No.: 206-294

Disconnection tool; green

Installation Notes

Installation

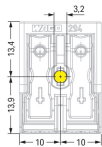

2-pole – without ground contact

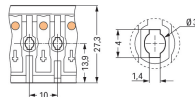

Mounting hole for screw
Notice: The maximum thread diameter for self-tapping screws is 3 mm.

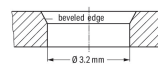

Hole for screw mount
Notice: The maximum thread diameter for self-tapping screws is 3 mm.

Conductor termination

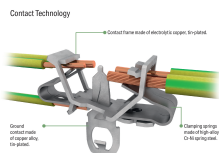

EUROPE
1 x 0.5 ... 2.5 mm ² "s"
1 x 0.5 ... 1.5 mm ² "s"
1 x 0.5 ... 0.75 mm ² "s"
AMERICA
1 x AWG 18 ... 14 "s"
1 x AWG 18 ... 16 "s"
1 x AWG 18 "s"
JAPAN
1 x 0.8 ... 1.6 mm diam. "s"
1 x 0.8 ... 1 mm diam. "s"
1 x 0.8 mm diam. "s"

EUROPE
2 x 0.5 ... 2.5 mm ² "s, str, f-str"
AMERICA
2 x AWG 18 ... 12 "s"
2 x AWG 18 ... 14 "s, f-str"
JAPAN
2 x 0.8 ... 2 mm diam. "s"
2 x 0.5 ... 2 mm ² str, f-str"

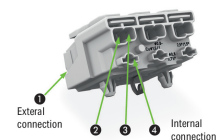

Internal connection:
PUSH WIRE® for internal wiring with solid conductors

External connection:
Push-in CAGE CLAMP® for field-wiring with all conductor types

Conductor termination

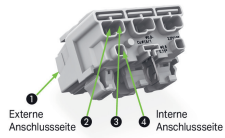

Terminating five conductors per pole – solid and fine-stranded.

