

Data Sheet | Item Number: 721-612/114-000

1-conductor male connector; CAGE CLAMP®; 2.5 mm²; Pin spacing 5 mm; 12-pole; 100% protected against mismatching; Snap-in flange; 2,50 mm²; light gray

<https://www.wago.com/721-612/114-000>



Color: ■ light gray

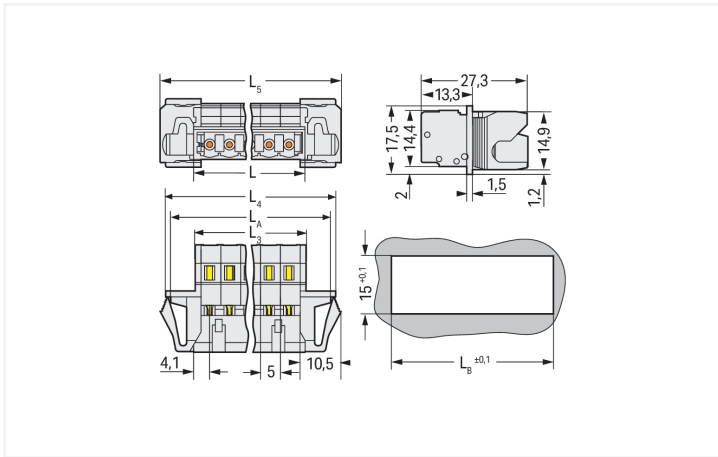

Dimensions in mm

$L = (\text{pole no.} \times \text{pin spacing}) + 3.2 \text{ mm}$
 $L_3 = L - 0.2 \text{ mm}$
 $L_4 = L_3 + 15.2 \text{ mm}$
 $L_5 = L_3 + 18 \text{ mm}$
 $L_A = L_3 + 12.6 \text{ mm}$
 $L_B = L_3 + 13.2 \text{ mm}$

Male connector, 721 Series, operating tool

This male connector (item number 721-612/114-000) is designed for hassle-free electrical installations. Strip lengths must be between 8 and 9 mm when connecting conductors to this male connector. This product features one conductor terminal and utilizes CAGE CLAMP®. Our reliable and maintenance-free CAGE CLAMP® connection makes it easy to connect all types of conductors without having to prepare the conductor. For example, you don't need to crimp ferrules. The item's dimensions are (81 x 17.5 x 27.5) mm (width x height x depth). Depending on the conductor type, this male connector is designed for conductor cross sections ranging from 0.08 mm² to 2.5 mm².

The contact surface is coated with tin.

Notes

Safety Information

The MCS – MULTI CONNECTION SYSTEM includes connectors without breaking capacity in accordance with DIN EN 61984. When used as intended, these connectors must not be connected/disconnected when live or under load. When used as intended, these connectors must not be connected/disconnected when live or under load. The circuit design should ensure header pins, which can be touched, are not live when unmated.

Variants:

Other pole numbers
Gold-plated or partially gold-plated contact surfaces
Other versions (or variants) can be requested from WAGO Sales or configured at <https://configurator.wago.com/>.

Electrical data

Ratings per IEC/EN 60664-1				Approvals per UL 1059			
	III	III	II	Use group	B	C	D
Overvoltage category	III	III	II	Rated voltage	300 V	-	300 V
Pollution degree	3	2	2	Rated current	15 A	-	10 A
Nominal voltage	320 V	320 V	630 V				
Rated impulse withstand voltage	4 kV	4 kV	4 kV				
Rated current	12 A	12 A	12 A				

Approvals per UL 1977		Approvals per CSA			
	600 V	Use group	B	C	D
Rated voltage	600 V	Rated voltage	300 V	-	300 V
Rated current	15 A	Rated current	15 A	-	10 A

Connection Data

Clamping units	12	Connection 1	
Total number of potentials	12	Connection technology	CAGE CLAMP®
Number of connection types	1	Actuation type	Operating tool
Number of levels	1	Actuation direction 1	Operation parallel to conductor entry
		Actuation direction 2	Operation perpendicular to conductor entry
		Solid conductor	0.08 ... 2.5 mm ² / 28 ... 12 AWG
		Fine-stranded conductor	0.08 ... 2.5 mm ² / 28 ... 12 AWG
		Fine-stranded conductor; with insulated ferrule	0.25 ... 1.5 mm ²
		Fine-stranded conductor; with uninsulated ferrule	0.25 ... 2.5 mm ²
		Strip length	8 ... 9 mm / 0.31 ... 0.35 inches
		Pole number	12
		Conductor entry direction to mating direction	0°

Physical data

Pin spacing	5 mm / 0.197 inches
Width	81 mm / 3.189 inches
Height	17.5 mm / 0.689 inches
Depth	27.5 mm / 1.083 inches

Mechanical data

Variable coding	Yes
Housing sheet thickness	0.5 ... 3 mm / 0.02 ... 0.118 inches
Direct ground contact to DIN-rail/drilled hole/housing	No
Mounting type	Snap-in flange
Mounting type	Feed-through mounting
Anti-rotation protection	Yes
Suitable for through-panel applications	Yes

Plug-in connection

Contact type (pluggable connector)	Male connector/plug
Connector (connection type)	for conductor
Mismating protection	Yes

Material data

Note (material data)	Information on material specifications can be found here
Color	light gray
Material group	I
Insulation material (main housing)	Polyamide (PA66)
Flammability class per UL94	V0
Clamping spring material	Chrome-nickel spring steel (CrNi)
Contact material	Electrolytic copper (E _{Cu})
Contact Plating	Tin
Fire load	0.383 MJ
Weight	20.5 g

Environmental requirements

Limit temperature range	-60 ... +100 °C
Processing temperature	-35 ... +60 °C

Commercial data

Product Group	3 (Multi Conn. System)
PU (SPU)	25 (18) pcs
Packaging type	Box
Country of origin	DE
GTIN	4050821280330
Customs tariff number	85366930000

Product Classification

UNSPSC	39121409
eCl@ss 10.0	27-44-03-09
eCl@ss 9.0	27-44-03-09
ETIM 9.0	EC002638
ETIM 10.0	EC002638
ECCN	NO US CLASSIFICATION

Environmental Product Compliance

RoHS Compliance Status	Compliant, No Exemption
------------------------	-------------------------

Approvals / Certificates

General approvals



Approval	Standard	Certificate Name
CB DEKRA Certification B.V.	IEC 61984	NL-113351
CSA DEKRA Certification B.V.	C22.2	1466354
KEMA/KEUR DEKRA Certification B.V.	EN 61984	71-130478 REV.1
UL Underwriters Laboratories Inc.	UL 1977	E45171
UL Underwriters Laboratories Inc.	UL 1059	E45172

Downloads

Environmental Product Compliance

Compliance Search	
Environmental Product Compliance 721-612/114-000	↓

Documentation

Additional Information			
Technical Section	03.04.2019	pdf 2027.26 KB	↓

CAD/CAE-Data

CAD data	
2D/3D Models 721-612/114-000	↓

CAE data	
ZUKEN Portal 721-612/114-000	↓

1 Compatible Products

1.1 System counterpart

1.1.1 Female connector/socket



Item No.: 721-112/026-000
 1-conductor female connector; CAGE CLAMP®; 2.5 mm²; Pin spacing 5 mm; 12-pole; 100% protected against mismatching; 2,50 mm²; light gray

1.2 Optional Accessories

1.2.1 Coding

1.2.1.1 Coding



Item No.: 231-129
 Coding key; snap-on type; light gray

1.2.2 Cover

1.2.2.1 Cover



Item No.: 231-668
 Lockout caps; for covering unused clamping units; gray

1.2.3 Ferrule

1.2.3.1 Ferrule



Item No.: 216-301
 Ferrule; Sleeve for 0.25 mm² / AWG 24; insulated; electro-tin plated; yellow



Item No.: 216-302
 Ferrule; Sleeve for 0.34 mm² / 22 AWG; insulated; electro-tin plated; light turquoise



Item No.: 216-201
 Ferrule; Sleeve for 0.5 mm² / 20 AWG; insulated; electro-tin plated; electrolytic copper; acc. to DIN 46228, Part 4/09.90; white



Item No.: 216-241
 Ferrule; Sleeve for 0.5 mm² / 20 AWG; insulated; electro-tin plated; electrolytic copper; gastight crimped; acc. to DIN 46228, Part 4/09.90; white



Item No.: 216-141
 Ferrule; Sleeve for 0.5 mm² / 20 AWG; un-insulated; electro-tin plated; electrolytic copper; gastight crimped; acc. to DIN 46228, Part 1/08.92



Item No.: 216-101
 Ferrule; Sleeve for 0.5 mm² / AWG 22; un-insulated; electro-tin plated; silver-colored



Item No.: 216-242
 Ferrule; Sleeve for 0.75 mm² / 18 AWG; insulated; electro-tin plated; electrolytic copper; gastight crimped; acc. to DIN 46228, Part 4/09.90; gray



Item No.: 216-262
 Ferrule; Sleeve for 0.75 mm² / 18 AWG; insulated; electro-tin plated; electrolytic copper; gastight crimped; acc. to DIN 46228, Part 4/09.90; gray



Item No.: 216-202
 Ferrule; Sleeve for 0.75 mm² / 18 AWG; insulated; electro-tin plated; gray



Item No.: 216-142
 Ferrule; Sleeve for 0.75 mm² / 18 AWG; un-insulated; electro-tin plated; electrolytic copper; gastight crimped; acc. to DIN 46228, Part 1/08.92













Item No.: 216-102
 Ferrule; Sleeve for 0.75 mm² / AWG 20; un-insulated; electro-tin plated; silver-colored





Item No.: 216-243
 Ferrule; Sleeve for 1 mm² / AWG 18; insulated; electro-tin plated; electrolytic copper; gastight crimped; acc. to DIN 46228, Part 4/09.90; red

1.2.3.1 Ferrule

 <p>Item No.: 216-263 Ferrule; Sleeve for 1 mm² / AWG 18; insulated; electro-tin plated; electrolytic copper; gastight crimped; acc. to DIN 46228, Part 4/09.90; red</p>	 <p>Item No.: 216-203 Ferrule; Sleeve for 1 mm² / AWG 18; insulated; electro-tin plated; red</p>	 <p>Item No.: 216-103 Ferrule; Sleeve for 1 mm² / AWG 18; un-insulated; electro-tin plated</p>	 <p>Item No.: 216-143 Ferrule; Sleeve for 1 mm² / AWG 18; un-insulated; electro-tin plated; electrolytic copper; gastight crimped; acc. to DIN 46228, Part 1/08.92</p>
 <p>Item No.: 216-204 Ferrule; Sleeve for 1.5 mm² / AWG 16; insulated; electro-tin plated; black</p>	 <p>Item No.: 216-244 Ferrule; Sleeve for 1.5 mm² / AWG 16; insulated; electro-tin plated; electrolytic copper; gastight crimped; acc. to DIN 46228, Part 4/09.90; black</p>	 <p>Item No.: 216-264 Ferrule; Sleeve for 1.5 mm² / AWG 16; insulated; electro-tin plated; electrolytic copper; gastight crimped; acc. to DIN 46228, Part 4/09.90; black</p>	 <p>Item No.: 216-284 Ferrule; Sleeve for 1.5 mm² / AWG 16; insulated; electro-tin plated; electrolytic copper; gastight crimped; acc. to DIN 46228, Part 4/09.90; black</p>
 <p>Item No.: 216-144 Ferrule; Sleeve for 1.5 mm² / AWG 16; un-insulated; electro-tin plated; electrolytic copper; gastight crimped; acc. to DIN 46228, Part 1/08.92; silver-colored</p>	 <p>Item No.: 216-104 Ferrule; Sleeve for 1.5 mm² / AWG 16; un-insulated; electro-tin plated; silver-colored</p>	 <p>Item No.: 216-106 Ferrule; Sleeve for 2.5 mm² / AWG 14; un-insulated; electro-tin plated; silver-colored</p>	





1.2.4 Insulation stop

1.2.4.1 Insulation stop

 <p>Item No.: 231-670 Insulation stop; 0.08-0.2 mm² / 0.2 mm² "s"; white</p>	 <p>Item No.: 231-671 Insulation stop; 0.25 - 0.5 mm²; light gray</p>	 <p>Item No.: 231-672 Insulation stop; 0.75 - 1 mm²; dark gray</p>	
--	--	--	--







1.2.5 Jumper

1.2.5.1 Jumper

 <p>Item No.: 231-910 Jumper; for conductor entry; 10-way; insulated; gray</p>	 <p>Item No.: 231-902 Jumper; for conductor entry; 2-way; insulated; gray</p>	 <p>Item No.: 231-903 Jumper; for conductor entry; 3-way; insulated; gray</p>	 <p>Item No.: 231-905 Jumper; for conductor entry; 5-way; insulated; gray</p>
 <p>Item No.: 231-907 Jumper; for conductor entry; 7-way; insulated; gray</p>			

1.2.6 Marking

1.2.6.1 Marking strip

			
<p>Item No.: 210-331/500-103 Marking strips; as a DIN A4 sheet; MARKED; 1-12 (300x); Height of marker strip: 2.3 mm/0.091 in; Strip length 182 mm; Horizontal marking; Self-adhesive; white</p>	<p>Item No.: 210-332/500-202 Marking strips; as a DIN A4 sheet; MARKED; 1-16 (160x); Height of marker strip: 3 mm; Strip length 182 mm; Horizontal marking; Self-adhesive; white</p>	<p>Item No.: 210-332/500-205 Marking strips; as a DIN A4 sheet; MARKED; 1-32 (80x); Height of marker strip: 3 mm; Strip length 182 mm; Horizontal marking; Self-adhesive; white</p>	<p>Item No.: 210-331/500-104 Marking strips; as a DIN A4 sheet; MARKED; 13-24 (300x); Height of marker strip: 2.3 mm/0.091 in; Strip length 182 mm; Horizontal marking; Self-adhesive; white</p>
 <p>Item No.: 210-332/500-204 Marking strips; as a DIN A4 sheet; MARKED; 17-32 (160x); Height of marker strip: 3 mm; Strip length 182 mm; Horizontal marking; Self-adhesive; white</p>	 <p>Item No.: 210-332/500-206 Marking strips; as a DIN A4 sheet; MARKED; 33-48 (160x); Height of marker strip: 3 mm; Strip length 182 mm; Horizontal marking; Self-adhesive; white</p>		

1.2.7 Strain relief

1.2.7.1 Strain relief housing



Item No.: 232-612

Strain relief housing; for female and male connectors; 2 parts; Pin spacing 5 mm; 12-pole; gray

1.2.8 Tool

1.2.8.1 Operating tool



Item No.: 231-231

Combination operating tool; red



Item No.: 210-720

Operating tool; Blade: 3.5 x 0.5 mm; with a partially insulated shaft; multicoloured



Item No.: 210-657

Operating tool; Blade: 3.5 x 0.5 mm; with a partially insulated shaft; short; multicoloured



Item No.: 280-440

Operating tool; made of insulating material; 10-way; white



Item No.: 209-130

Operating tool; made of insulating material; 1-way; for 264 Series (1-/2-way), 280, 281 Series (up to 3-way); natural



Item No.: 231-291

Operating tool; made of insulating material; 1-way; loose; red



Item No.: 231-131

Operating tool; made of insulating material; 1-way; loose; white



Item No.: 280-432

Operating tool; made of insulating material; 2-way; white



Item No.: 280-433

Operating tool; made of insulating material; 3-way; white



Item No.: 280-434

Operating tool; made of insulating material; 4-way; white



Item No.: 280-435

Operating tool; made of insulating material; 5-way; gray



Item No.: 280-436

Operating tool; made of insulating material; 6-way; white



Item No.: 280-437

Operating tool; made of insulating material; 7-way; white



Item No.: 280-438

Operating tool; made of insulating material; 8-way; white



Item No.: 231-159

Operating tool; natural

Installation Notes

Conductor termination

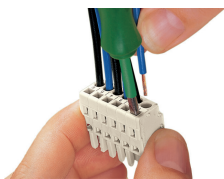

Inserting a conductor via 3.5 mm screwdriver – CAGE CLAMP® actuation parallel to conductor entry.

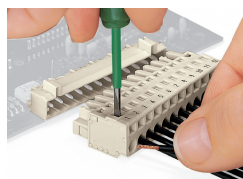

Inserting a conductor via 3.5 mm screwdriver – CAGE CLAMP® actuation perpendicular to conductor entry.

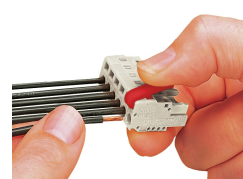

Inserting a conductor via operating tool.

Testing

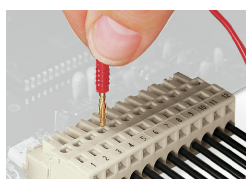

Testing perpendicular to conductor entry with 2 or 2.3 mm Ø test plug – female connector with CAGE CLAMP® – via integrated test ports

Installation



Male connector with strain relief plate

Strain relief housing shown with a male connector equipped with CAGE CLAMP®

Coding

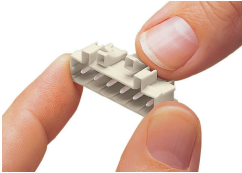

Coding a male header – fitting coding key (s).