

Contactstop ProTOP

Bestelnr. 165



- schroefklemmen
- wartel met afdichting
- trekontlasting met knikbescherming
- behuizing met schroefdraad met vergrendeling

Technische informatie

Ampère	32 A
Polen	4 p
Voltage	500 V
Uurstand	7 h
Hertz	50-60 Hz
Aansluittechniek	schroefklemmen
Contacten	standaard
Beschermingsgraad	IP 44
Gewicht	270 g
Certificeringen	VDE, EAC, CQC

Tekeningen

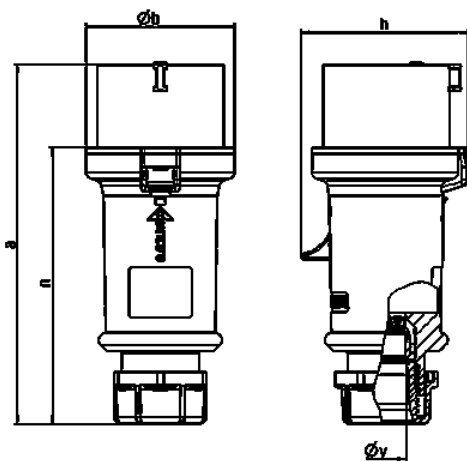

Tekening 2 MB 214	Amp. Polen	16			32		
		3	4	5	3	4	5
Maten in mm	a	148	160	160	197	197	197
	b	55	65,6	65,6	75	75	75
	h	61	72,5	72,5	80,5	80,5	85
	n	112	123,5	123,5	152	152	152
	y	14,5	16	16	22	22	22
Kabelaansluiting		1	1	1	2,5	2,5	2,5
van/tot mm²		-2,5	-2,5	-2,5	-6	-6	-6