

Data Sheet | Item Number: 831-305

Snap-in frame; for male connectors; 1 part; Pin spacing 7.62 mm; 5-pole; light gray

<https://www.wago.com/831-305>

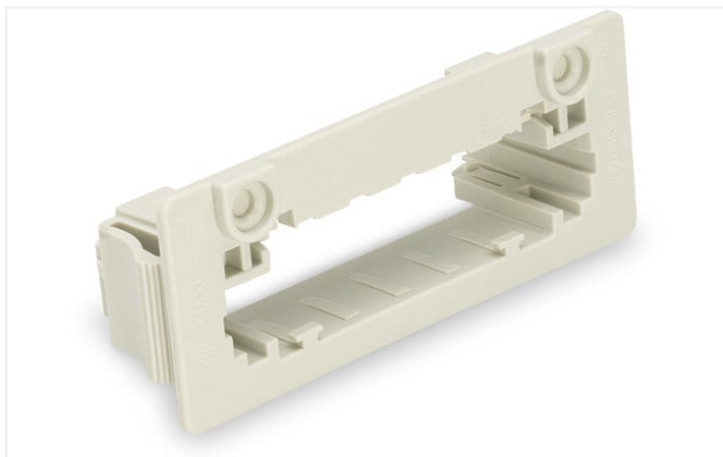

Color: ■ light gray

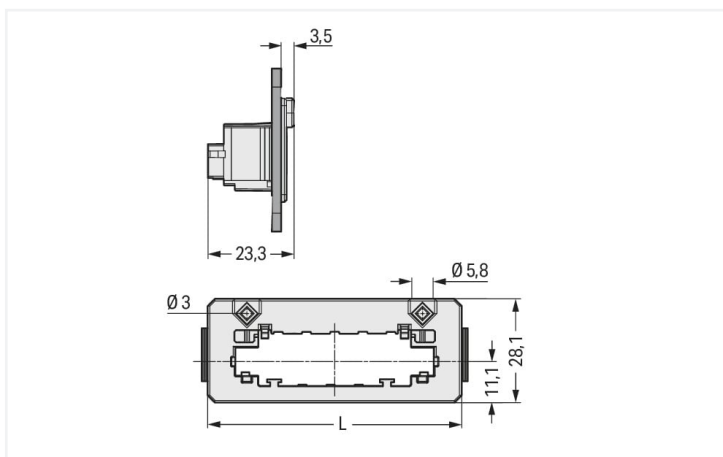

Dimensions in mm

$L = (\text{pole no.} \times 7.62 \text{ mm}) + 30.6 \text{ mm}$

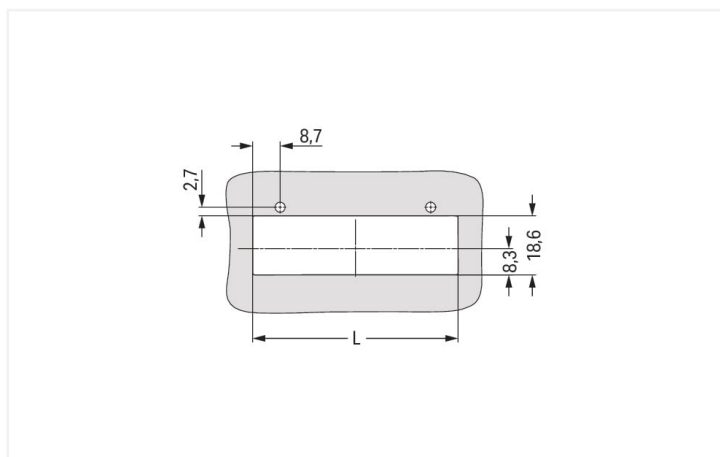

Dimensions in mm

Panel cutout for snap-in frame

$L = (\text{pole no.} \times 7.62 \text{ mm}) + 26.8 \text{ mm}$

- Snap-in frames for through-panel MCS MAXI connectors
- Fast and easy installation – without tools
- Compatible with MCS MAXI male and female connectors
- For panel thickness ranging from 0.5 to 2.5 mm
- Optional screw mounting

Connection data

Connection 1

Pole number	5
-------------	---

Physical data

Width	68.7 mm / 2.705 inches
Height	28.1 mm / 1.106 inches
Depth	23.3 mm / 0.917 inches

Mechanical data

Housing sheet thickness	0.5 ... 2.5 mm / 0.02 ... 0.098 inches
Mounting type	Snap-in flange Feed-through mounting

Plug-in connection

Mismating protection	Yes
----------------------	-----

Material data

Note (material data)	Information on material specifications can be found here
Color	light gray
Material group	I
Insulation material	Polyamide (PA66)
Flammability class per UL94	V0
Fire load	0 MJ
Weight	7.2 g

Commercial data

ETIM 8.0	EC002848
ETIM 7.0	EC002848
PU (SPU)	12 pcs
Packaging type	Box
Country of origin	DE
GTIN	4055143564915
Customs tariff number	39269097900

Environmental Product Compliance

RoHS Compliance Status	Compliant, No Exemption
------------------------	-------------------------

Downloads

Environmental Product Compliance

Compliance Search

Environmental Product
Compliance 831-305



Documentation

Additional Information

Technical Section	03.04.2019	pdf 2010.85 KB	↓
-------------------	------------	-------------------	---

CAD/CAE-Data

CAD data

2D/3D Models 831-305	↓
----------------------	---

CAE data

ZUKEN Portal 831-305	↓
----------------------	---

1 Compatible Products

1.1 Optional Accessories

1.1.1 Cover

1.1.1.1 Snap-in frame



Item No.: 831-321

Lockout pin; for male connectors; 2 parts; light gray

Installation Notes

Installation

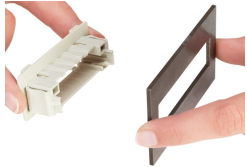

Insert the snap-in frame into the cutout.

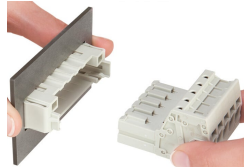

Insert the male connector into the snap-in frame.

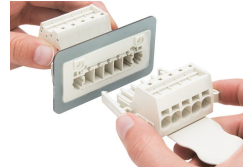

Inserting a female connector equipped with lateral locking levers.

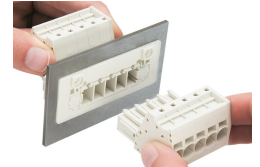

Inserting a female connector without lateral locking levers – lockout pins are inserted on both sides of the snap-in frame.