

## Data Sheet | Item Number: 731-610/018-000

1-conductor male connector; CAGE CLAMP®; 2.5 mm<sup>2</sup>; Pin spacing 7.5 mm; 10-pole; DIN-35 rail/panel mounting; Snap-in mounting feet; 2,50 mm<sup>2</sup>; gray

<https://www.wago.com/731-610/018-000>

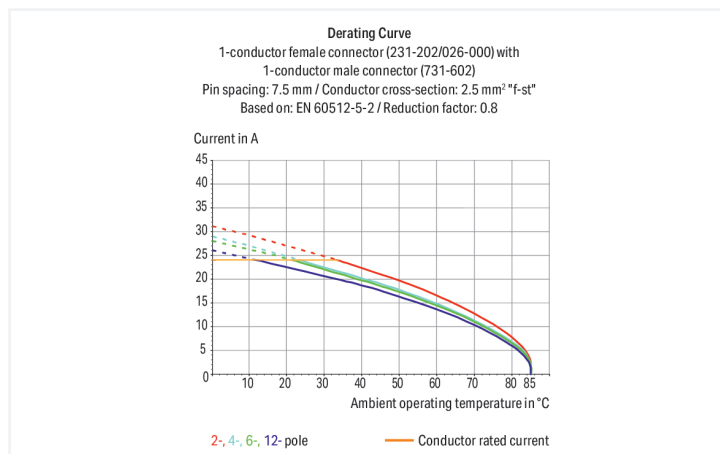

Color: ■ gray

Similar to illustration

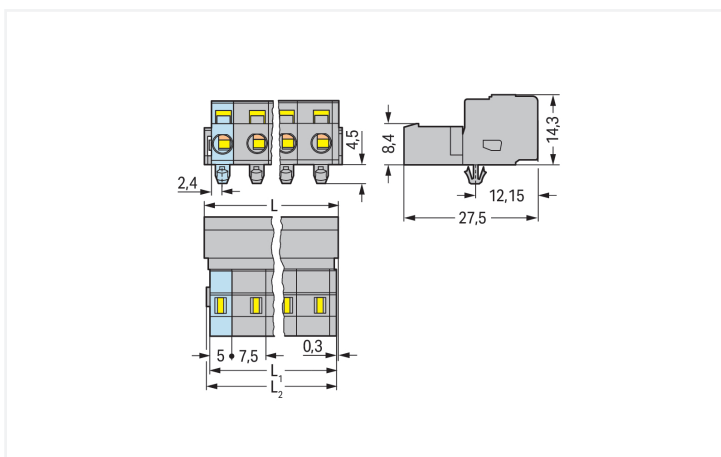

Dimensions in mm

$L = (\text{pole no.} - 1) \times \text{pin spacing} + 8.2 \text{ mm}$   
 $L_1 = L - 1.7 \text{ mm}$   
 $L_2 = L - 1.2 \text{ mm}$

Male connector, 731 Series, gray

Our male connector (item number 731-610/018-000) ensures effortless electrical installations. Conductors can only be connected to this male connector if their strip length is between 8 and 9 mm. This product features one conductor terminal and utilizes CAGE CLAMP®. Our reliable and maintenance-free CAGE CLAMP® connection makes it easy to connect all conductor types without having to prepare the conductor. For example, you don't need to crimp ferrules. The item's dimensions are (75.7 x 18.8 x 27.5) mm (width x height x depth). Depending on the type of conductor, this male connector is designed for conductor cross sections ranging from 0.08 mm<sup>2</sup> to 2.5 mm<sup>2</sup>.

The contact surface is coated with tin.

## Notes

## Safety Information

The MCS – MULTI CONNECTION SYSTEM includes connectors without breaking capacity in accordance with DIN EN 61984. When used as intended, these connectors must not be connected/disconnected when live or under load. When used as intended, these connectors must not be connected/disconnected when live or under load. The circuit design should ensure header pins, which can be touched, are not live when unmated.

## Variants:

Other pole numbers  
Gold-plated or partially gold-plated contact surfaces  
Other versions (or variants) can be requested from WAGO Sales or configured at <https://configurator.wago.com/>.

## Electrical data

Ratings per		IEC/EN 60664-1			Approvals per		UL 1059		
Overvoltage category		III	III	II	Use group	B	C	D	
Pollution degree		3	2	2	Rated voltage	300 V	-	300 V	
Nominal voltage		500 V	630 V	1000 V	Rated current	15 A	-	10 A	
Rated impulse withstand voltage		6 kV	6 kV	6 kV					
Rated current		12 A	12 A	12 A					

Approvals per		UL 1977			Approvals per		CSA		
Rated voltage		600 V			Use group	B	C	D	
Rated current		15 A			Rated voltage	300 V	-	300 V	
					Rated current	15 A	-	10 A	

## Connection Data

Clamping units	10	<b>Connection 1</b>	
Total number of potentials	10	Connection technology	CAGE CLAMP®
Number of connection types	1	Actuation type	Operating tool
Number of levels	1	Actuation direction 1	Operation parallel to conductor entry
		Actuation direction 2	Operation perpendicular to conductor entry
		Solid conductor	0.08 ... 2.5 mm <sup>2</sup> / 28 ... 12 AWG
		Fine-stranded conductor	0.08 ... 2.5 mm <sup>2</sup> / 28 ... 12 AWG
		Fine-stranded conductor; with insulated ferrule	0.25 ... 1.5 mm <sup>2</sup>
		Fine-stranded conductor; with uninsulated ferrule	0.25 ... 2.5 mm <sup>2</sup>
		Strip length	8 ... 9 mm / 0.31 ... 0.35 inches
		Pole number	10
		Conductor entry direction to mating direction	0°

## Physical data

Pin spacing	7.5 mm / 0.295 inches
Width	75.7 mm / 2.98 inches
Height	18.8 mm / 0.74 inches
Height from the surface	14.3 mm / 0.563 inches
Depth	27.5 mm / 1.083 inches
Drilled hole diameter for snap-in mounting foot with tolerance	3.5 (+0.1) mm

### Mechanical data

Variable coding	Yes
Housing sheet thickness	0.6 ... 1.2 mm / 0.024 ... 0.047 inches
Mounting type	Snap-in foot
Mounting type	Panel mounting
Anti-rotation protection	Yes

### Plug-in connection

Contact type (pluggable connector)	Male connector/plug
Connector (connection type)	for conductor
Mismating protection	No

### Material data

Note (material data)	<a href="#">Information on material specifications can be found here</a>
Color	gray
Material group	I
Insulation material (main housing)	Polyamide (PA66)
Flammability class per UL94	V0
Clamping spring material	Chrome-nickel spring steel (CrNi)
Contact material	Electrolytic copper (E <sub>CU</sub> )
Contact Plating	Tin
Fire load	0.341 MJ
Weight	17.9 g

### Environmental requirements

Limit temperature range	-60 ... +100 °C
Processing temperature	-35 ... +60 °C

### Environmental Testing

Test specification: Railway applications – Rolling stock – Electronic equipment	DIN EN 50155 (VDE 0115-200):2022-06
Test procedure: Railway applications – Rolling stock equipment – Vibration and shock tests	DIN EN 61373 (VDE 0115-0106):2011-04
Spectrum/Mounting location	Service life test, Category 1, Class A/B
Functional test with noise-like oscillations	Test passed according to Section 8 of the standard
Frequency	f <sub>1</sub> = 5 Hz to f <sub>2</sub> = 150 Hz
Acceleration	0.101g (highest test level used for all axes)
Test duration per axis	10 min.
Test directions	X, Y and Z axes
Monitoring of contact faults and interruptions	Passed
Voltage drop measurement before and after each axis	Passed
Simulated service life test through increased levels of noise-like oscillations	Test passed according to Section 9 of the standard
Frequency	f <sub>1</sub> = 5 Hz to f <sub>2</sub> = 150 Hz
Acceleration	0.572g (highest test level used for all axes)
Test duration per axis	5 h
Test directions	X, Y and Z axes
Extended testing: Monitoring of contact faults and interruptions	Passed
Extended testing: Voltage drop measurement before and after each axis	Passed

### Environmental Testing

Shock test	Test passed according to Section 10 of the standard
Shock pulse form	Half sine
Acceleration	5g (highest test level used for all axes)
Shock duration	30 ms
Number of shocks (per axis)	3 pos. und 3 neg.
Test directions	X, Y and Z axes
Extended testing: Monitoring of contact faults and interruptions	Passed
Extended testing: Voltage drop measurement before and after each axis	Passed
Vibration and shock stress for rolling stock equipment	Passed

### Commercial data

Product Group	3 (Multi Conn. System)
PU (SPU)	25 pcs
Packaging type	Box
Country of origin	DE
GTIN	4044918267151
Customs tariff number	85366930000

### Product Classification

UNSPSC	39121409
eCl@ss 10.0	27-44-03-09
eCl@ss 9.0	27-44-03-09
ETIM 9.0	EC002638
ETIM 10.0	EC002638
ECCN	NO US CLASSIFICATION

### Environmental Product Compliance

RoHS Compliance Status	Compliant, No Exemption
------------------------	-------------------------

### Approvals / Certificates

#### General approvals



Approval	Standard	Certificate Name
CB DEKRA Certification B.V.	IEC 61984	NL-113351
KEMA/KEUR DEKRA Certification B.V.	EN 61984	71-130478 REV.1
UR Underwriters Laboratories Inc.	UL 1977	E 45171
UR Underwriters Laboratories Inc.	UL 1059	E45172

#### Declarations of conformity and manufacturer's declarations



Approval	Standard	Certificate Name
Railway WAGO GmbH & Co. KG	-	Railway Ready

Approvals for marine applications



Approval	Standard	Certificate Name
ABS American Bureau of Ship- ping	-	24-0095975-PDA
BV Bureau Veritas S.A.	IEC 60998	11915/E0 BV
DNV DNV GL SE	-	TAE000016Z
PRS Polski Rejestr Statków	-	TE/1095/880590/23

Downloads

Environmental Product Compliance

Compliance Search
Environmental Product Compliance 731-610/018-000 <a href="#">↓</a>

Documentation

Additional Information			
Technical Section	03.04.2019	pdf 2027.26 KB	<a href="#">↓</a>

CAD/CAE-Data

CAD data
2D/3D Models 731-610/018-000 <a href="#">↓</a>

CAE data
EPLAN Data Portal 731-610/018-000 <a href="#">↓</a>
ZUKEN Portal 731-610/018-000 <a href="#">↓</a>

1 Compatible Products

1.1 System counterpart

1.1.1 Female connector/socket



**Item No.: 231-210/026-000**  
 1-conductor female connector; CAGE  
 CLAMP®; 2.5 mm²; Pin spacing 7.5 mm;  
 10-pole; gray

1.2 Optional Accessories

1.2.1 Coding

1.2.1.1 Coding



**Item No.: 231-130**

Coding key; snap-on type; light gray

1.2.2 Cover

1.2.2.1 Cover



**Item No.: 231-668**

Lockout caps; for covering unused clamping units; gray

1.2.3 Ferrule

1.2.3.1 Ferrule



**Item No.: 216-301**

Ferrule; Sleeve for 0.25 mm<sup>2</sup> / AWG 24; insulated; electro-tin plated; yellow



**Item No.: 216-302**

Ferrule; Sleeve for 0.34 mm<sup>2</sup> / 22 AWG; insulated; electro-tin plated; light turquoise



**Item No.: 216-201**

Ferrule; Sleeve for 0.5 mm<sup>2</sup> / 20 AWG; insulated; electro-tin plated; electrolytic copper; acc. to DIN 46228, Part 4/09.90; white



**Item No.: 216-241**

Ferrule; Sleeve for 0.5 mm<sup>2</sup> / 20 AWG; insulated; electro-tin plated; electrolytic copper; gastight crimped; acc. to DIN 46228, Part 4/09.90; white



**Item No.: 216-141**

Ferrule; Sleeve for 0.5 mm<sup>2</sup> / 20 AWG; un-insulated; electro-tin plated; electrolytic copper; gastight crimped; acc. to DIN 46228, Part 1/08.92



**Item No.: 216-101**

Ferrule; Sleeve for 0.5 mm<sup>2</sup> / AWG 22; un-insulated; electro-tin plated; silver-colored



**Item No.: 216-242**

Ferrule; Sleeve for 0.75 mm<sup>2</sup> / 18 AWG; insulated; electro-tin plated; electrolytic copper; gastight crimped; acc. to DIN 46228, Part 4/09.90; gray



**Item No.: 216-262**

Ferrule; Sleeve for 0.75 mm<sup>2</sup> / 18 AWG; insulated; electro-tin plated; electrolytic copper; gastight crimped; acc. to DIN 46228, Part 4/09.90; gray



**Item No.: 216-202**

Ferrule; Sleeve for 0.75 mm<sup>2</sup> / 18 AWG; insulated; electro-tin plated; gray



**Item No.: 216-142**

Ferrule; Sleeve for 0.75 mm<sup>2</sup> / 18 AWG; un-insulated; electro-tin plated; electrolytic copper; gastight crimped; acc. to DIN 46228, Part 1/08.92



**Item No.: 216-102**

Ferrule; Sleeve for 0.75 mm<sup>2</sup> / AWG 20; un-insulated; electro-tin plated; silver-colored



**Item No.: 216-243**

Ferrule; Sleeve for 1 mm<sup>2</sup> / AWG 18; insulated; electro-tin plated; electrolytic copper; gastight crimped; acc. to DIN 46228, Part 4/09.90; red



**Item No.: 216-263**

Ferrule; Sleeve for 1 mm<sup>2</sup> / AWG 18; insulated; electro-tin plated; electrolytic copper; gastight crimped; acc. to DIN 46228, Part 4/09.90; red



**Item No.: 216-203**

Ferrule; Sleeve for 1 mm<sup>2</sup> / AWG 18; insulated; electro-tin plated; red



**Item No.: 216-103**

Ferrule; Sleeve for 1 mm<sup>2</sup> / AWG 18; un-insulated; electro-tin plated



**Item No.: 216-143**

Ferrule; Sleeve for 1 mm<sup>2</sup> / AWG 18; un-insulated; electro-tin plated; electrolytic copper; gastight crimped; acc. to DIN 46228, Part 1/08.92



**Item No.: 216-204**

Ferrule; Sleeve for 1.5 mm<sup>2</sup> / AWG 16; insulated; electro-tin plated; black



**Item No.: 216-244**

Ferrule; Sleeve for 1.5 mm<sup>2</sup> / AWG 16; insulated; electro-tin plated; electrolytic copper; gastight crimped; acc. to DIN 46228, Part 4/09.90; black



**Item No.: 216-264**

Ferrule; Sleeve for 1.5 mm<sup>2</sup> / AWG 16; insulated; electro-tin plated; electrolytic copper; gastight crimped; acc. to DIN 46228, Part 4/09.90; black



**Item No.: 216-284**

Ferrule; Sleeve for 1.5 mm<sup>2</sup> / AWG 16; insulated; electro-tin plated; electrolytic copper; gastight crimped; acc. to DIN 46228, Part 4/09.90; black



**Item No.: 216-144**

Ferrule; Sleeve for 1.5 mm<sup>2</sup> / AWG 16; un-insulated; electro-tin plated; electrolytic copper; gastight crimped; acc. to DIN 46228, Part 1/08.92; silver-colored



**Item No.: 216-104**

Ferrule; Sleeve for 1.5 mm<sup>2</sup> / AWG 16; un-insulated; electro-tin plated; silver-colored



**Item No.: 216-106**

Ferrule; Sleeve for 2.5 mm<sup>2</sup> / AWG 14; un-insulated; electro-tin plated; silver-colored

## 1.2.4 Installation

### 1.2.4.1 Mounting accessories



**Item No.: 209-137**

Mounting adapter; can be used as end stop; 6.5 mm wide; gray

## 1.2.5 Insulation stop

### 1.2.5.1 Insulation stop



**Item No.: 231-673**

Insulation stop; 0.08-0.2 mm<sup>2</sup> / 0.2 mm<sup>2</sup> "s"; white



**Item No.: 231-674**

Insulation stop; 0.25 - 0.5 mm<sup>2</sup>; light gray



**Item No.: 231-675**

Insulation stop; 0.75 - 1 mm<sup>2</sup>; dark gray

## 1.2.6 Marking

### 1.2.6.1 Marking strip



**Item No.: 210-331/750-202**

Marking strips; as a DIN A4 sheet; MARKED; 1-16 (100x); Height of marker strip: 2.3 mm/0.091 in; Strip length 182 mm; Horizontal marking; Self-adhesive; white



**Item No.: 210-332/750-020**

Marking strips; as a DIN A4 sheet; MARKED; 1-20 (80x); Height of marker strip: 3 mm; Strip length 182 mm; Horizontal marking; Self-adhesive; white

## 1.2.7 Mounting adapter

### 1.2.7.1 Mounting accessories



**Item No.: 209-148**

Multi mounting adapter; for female and male connectors; 25 mm wide; 3 parts; gray

## 1.2.8 Strain relief

### 1.2.8.1 Strain relief housing



**Item No.: 232-670**

Strain relief housing; for female and male connectors; 2 parts; Pin spacing 7.5 mm; 10-pole; gray

## 1.2.9 Tool

### 1.2.9.1 Operating tool



**Item No.: 210-720**

Operating tool; Blade: 3.5 x 0.5 mm; with a partially insulated shaft; multicoloured



**Item No.: 210-657**

Operating tool; Blade: 3.5 x 0.5 mm; with a partially insulated shaft; short; multicoloured



**Item No.: 231-291**

Operating tool; made of insulating material; 1-way; loose; red



**Item No.: 231-131**

Operating tool; made of insulating material; 1-way; loose; white

## Installation Notes

### Conductor termination

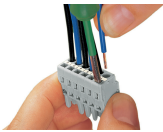

Inserting a conductor via 3.5 mm screwdriver – CAGE CLAMP® actuation parallel to conductor entry.

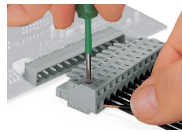

Inserting a conductor via 3.5 mm screwdriver – CAGE CLAMP® actuation perpendicular to conductor entry.

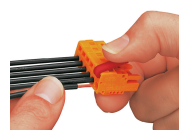

Inserting a conductor into CAGE CLAMP® unit via operating tool (231-291).



Inserting a conductor via operating tool.

## Coding

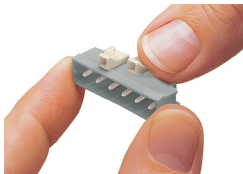

Coding a male header – fitting coding key(s).

## Testing

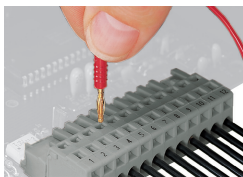

Testing – female connector with CAGE CLAMP®  
Integrated test ports for testing perpendicular to conductor entry via 2 or 2.3 mm Ø test plug

## Installation

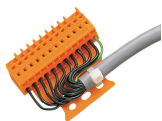

Male connector with strain relief plate



Strain relief housing shown with a male connector equipped with CAGE CLAMP®

Marking



Labeling via direct marking or self-adhesive strips.