

Productinformatieblad

Specificaties



XB5 - Kop voor keuzeschakelaar - 2 pos - Geel - Blijft in stand - Verlicht

ZB5FK1283

Belangrijk bericht: A change in appearance may be noted on the product but does not affect its use in terms of function and safety. This makes it compatible with our Universal LED blocks
EAN Code: 3606481339720

Prijs: 21,70 EUR

Hoofd

range of product	Harmony XB5
product of component type	Kop voor verlichte keuzeschakelaar
compatibiliteit product	Universele LED
device short name	ZB5
kraag materiaal	Donkergrijs kunststof
bevestigingsdiameter	30,5 mm
koptype	Built-in-flush
verkoop per ondeelbare hoeveelheid	1
vorm van kop signaleringseenheid	Rond
type operator	blijven
operator profiel	Geel standaard hendel
informatie positie operator	2 standen 90°

Complementair

CAD totale breedte	37 mm
CAD totale hoogte	37 mm
CAD totale diepte	46 mm
gewicht product	0,03 kg
mechanical durability	1000000 cycles
elektrische samenstellingscode	M3 voor <4 contacten gebruik enkelvoudig blokken in vooraan gemonteerd met integrale LED M6 voor <2 contacten gebruik enkelvoudig blokken in vooraan gemonteerd met ingebouwde LED en transformator M10 voor <2 contacten gebruik enkelvoudig blokken in vooraan gemonteerd met integrale LED MF1 voor <2 contacten gebruik enkelvoudig blokken in vooraan gemonteerd met integrale LED M4 voor <4 contacten gebruik enkelvoudig en dubbel blokken in vooraan gemonteerd met integrale LED

Omgeving

beschermende behandeling	TH
ambient air temperature for storage	-40...70 °C
omgevingstemperatuur voor werking	-40...70 °C

De weergegeven prijs is de adviesprijs in euro excl. BTW. Deze kan onderhevig zijn aan korting. Neem contact op met uw lokale distributeur of detailhandel voor de daadwerkelijke prijs

overvoltage category	Klasse II In overeenstemming met IEC 60536
IP beschermingsgraad	IP66 In overeenstemming met IEC 60529 IP67 IP69 IP69K
Enclosure Type	UL type 4X/13
weerstand hoge druk drukring	7000000 Pa om 55 °C, afstand: 0.1 m
IK-beschermingsgraad	IK03 In overeenstemming met IEC 50102
standards	EN/IEC 60947-5-4 JIS C8201-5-1 CSA C22.2 Nr 14 EN/IEC 60947-1 EN/IEC 60947-5-1 UL 508 EN/IEC 60947-5-5 JIS C8201-1
product certifications	CSA DNV BV LROS (Lloyds register of shipping) UL listed
trilling bestendigheid	5 gn (f= 2...500 Hz) In overeenstemming met IEC 60068-2-6
schokbestendigheid	30 gn (duur = 18 ms) voor halve sinusgolf versnelling In overeenstemming met IEC 60068-2-27 50 gn (duur = 11 ms) voor halve sinusgolf versnelling In overeenstemming met IEC 60068-2-27

Verpakkingseenheid

Eenheidstype van verpakking 1	PCE
Aantal eenheden in verpakking 1	1
verpakking 1 hoogte	5,45 cm
verpakking 1 breedte	4,3 cm
verpakking 1 lengte	5,2 cm
verpakking_1_gewicht	22,0 g

contractuele waarborg

Garantie (in maanden)	18
------------------------------	----

Schneider Electric wil tegen 2050 de Net Zero-status hebben bereikt via partnerschappen in de toeleveringsketen, materialen met een lagere impact en circulariteit via onze doorlopende campagne "Use Better, Use Longer, Use Again" om de levensduur van producten en de recycleerbaarheid te verlengen.

[Uitleg van Environmental Data >](#)

[Hoe evalueren we de duurzaamheid van producten? >](#)

Milieuoetafdruk

Totale levenscyclus ecologische voetafdruk	0.2 kg CO2 eq.
Koolstofvoetafdruk van de fabricagefase [A1–A3]	0.2 kg CO2 eq.
Koolstofvoetafdruk van de distributiefase [A4]	0 kg CO2 eq.
Koolstofvoetafdruk van de installatiefase [A5]	0 kg CO2 eq.
Koolstofvoetafdruk van de gebruiksfase [B2, B3, B4, B6]	0 kg CO2 eq.
Koolstofvoetafdruk van de einde-levensfase [C1–C4]	0 kg CO2 eq.
Milieu Profiel	Milieuprofiel van het product

Use Better

Materialen en verpakking

Pakket met gerecycleerd karton	Ja
Verpakkingen zonder kunststof	Ja
RoHS-richtlijn van de EU	Conform
REACH-verordening	Referentie bevat geen SVHC boven drempelwaarde

Use Longer

Levensduurverlenging

Reparatie	Nee
-----------	-----

Use Again

Herverpakken en herfabriceren

Percentage mogelijke recycleerbaarheid	33
Circulair Profiel	Informatie over einde levensduur
Terugname	Ja

Dimensions Drawings

Dimensions

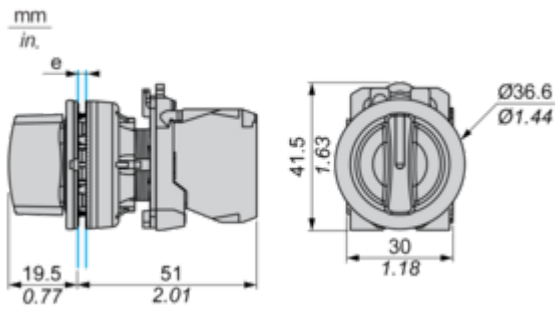

e: Clamping thickness: 1 to 6 mm / 0.04 to 0.24 in.

Mounting and Clearance

Panel Cut-out for Pushbuttons, Switches and Pilot Lights (Finished Holes, Ready for Installation)

Connection by Screw Clamp Terminals or Plug-in Connectors



(1) Diameter on finished panel or support

(2) $\varnothing 30.75 \text{ mm}$ recommended ($\varnothing 30.5 \text{ mm}^{+0.5}_0$) / $\varnothing 1.21 \text{ in.}$ recommended ($\varnothing 1.20 \text{ in.}^{+0.0196}_0$)

Connections	a in mm	a in in.	b in mm	b in in.
By screw clamp terminals or plug-in connector	40	1.57	40	1.57
By Faston connectors	45	1.77	40	1.57

Technical Description

Electrical Composition Corresponding to Code M3

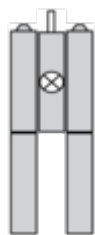

Electrical Composition Corresponding to Code M4



Electrical Composition Corresponding to Codes M6 and P2



Electrical Composition Corresponding to Codes M5, M10, MF1, MR1 and MF2



Legend

Single contact



Double contact



Light block



Possible location



Sequence of Contacts Fitted to 2-position Selector Switch Body

Position 315°



Push	Position	Top			
		Bottom			
	Location		Left		Right
	State		0		0
	Contacts	N/O			open
N/C		closed	closed		

Position 45°



Push	Position	Top			
		Bottom			
	Location		Left		Right
	State		1		1
Contacts	N/O		closed	closed	
	N/C		open	open	

Technical Illustration

Dimensions

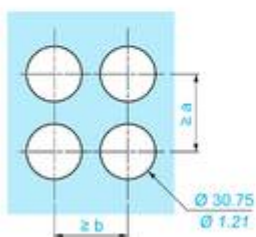
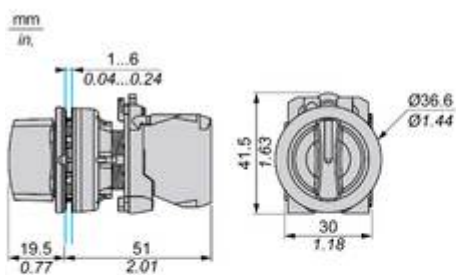







		a (mm)	a (in.)	b (mm)	b (in.)
		40	1.57	40	1.57
ZBE.....	ZBV.....				
		45	1.77	40	1.57
ZBE.....3	ZBV.....3				
		40	1.57	40	1.57
ZBE.....4	ZBV.....4				

Image of product / Alternate images

Alternative

