

Contactstop

Bestelnr. 636A



- schroefklemmen met tule

Technische informatie

Ampère	16 A
Polen	3 p
Voltage	20-25 V
Hertz	50-60 Hz
Aansluittechniek	schroefklemmen
Contacten	standaard
Beschermingsgraad	IP 44
Gewicht	153 g
Certificeringen	EAC

Tekeningen

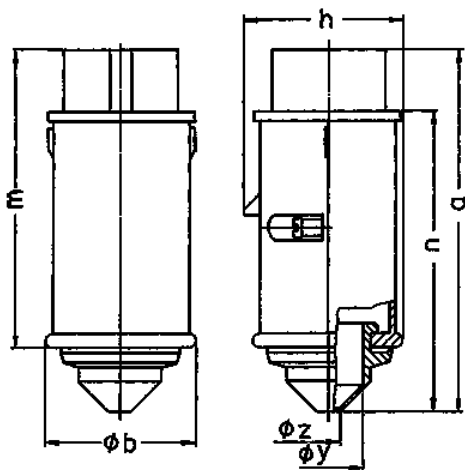

Tekening	Amp. Polen	16		32	
		2	3	2	3
Maten in mm	a	130	130	130	130
	b	55	55	55	55
	h	58	58	58	58
	m	108	108	108	108
	n	107	107	107	107
	y	25	25	25	25
	z	9	9	9	9
Kabelaansluiting		4	4	4	4
van/tot mm²		-10	-10	-10	-10