

EU6E-SWD-..., EU8E-SWD-...

→  Eaton.com/documentation
MN120006...
MN05006002Z...
IL04716001Z...
Eaton.com/swd
Eaton.com/smartyredt

Mounting

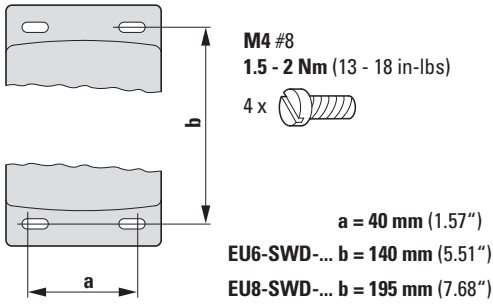

Connections

PWR IN, PWR OUT

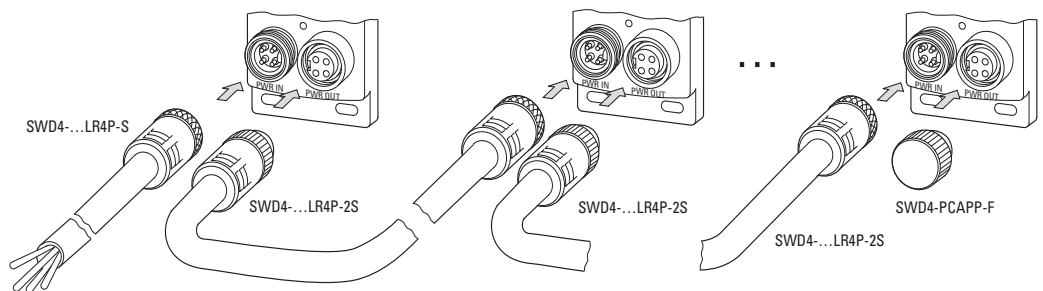
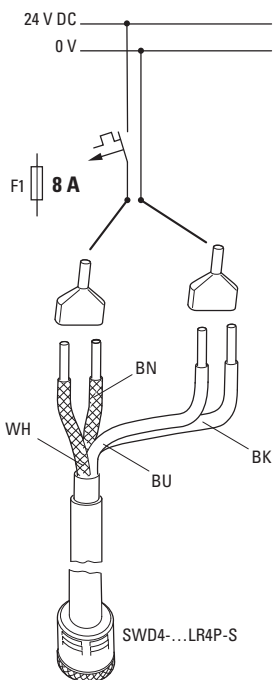
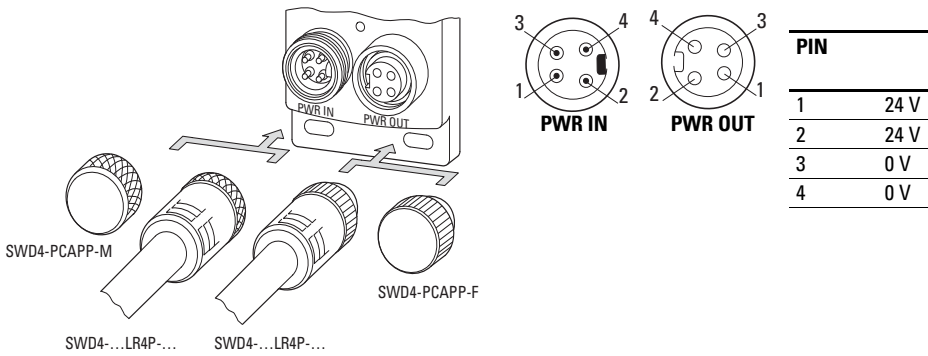

SWD4-...LR4P-S, SWD4-...LR4P-R		PWR IN	
IEC 60757	PIN	PIN	
BN	Brown 1	3	24 V
WH	White 2	4	24 V
BU	Blue 3	1	0 V
BK	Black 4	2	0 V

SWD IN, SWD OUT

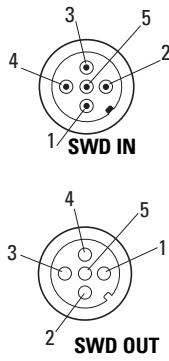
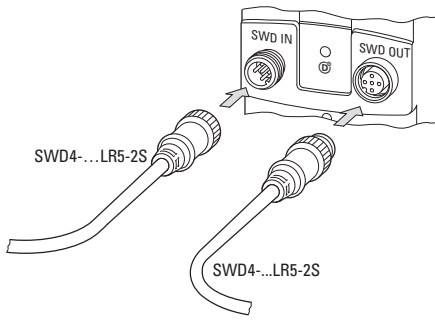

SWD IN					
	1	2	3	4	5
EU6...-SWD-...	24 V	A	0 V	B	SEL
EU8...-SWD-...	24 V	A	0 V	B	SEL

SWD OUT					
	1	2	3	4	5
EU6...-SWD-...	24 V	A	0 V	B	SEL
EU8...-SWD-...	24 V	A	0 V	B	SEL

X1...Xn

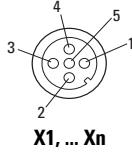
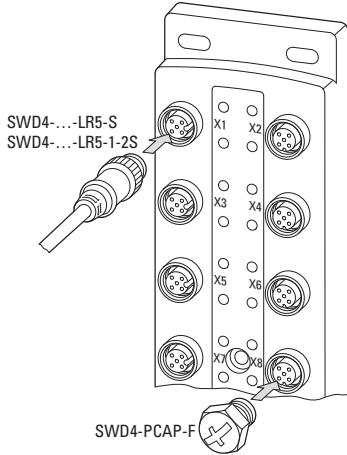

EU6E-SWD-...

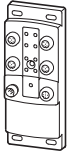

	X1...Xn			X1		X2		X3		X4	
	1	3	5	2	4	2	4	2	4	2	4
EU6E-SWD-2D2D-1	24 V	0 V	-	-	Q0	-	Q1	-	I0	-	I1
EU6E-SWD-2D2D-2	24 V	0 V	-	-	Q0	-	Q1	-	I0	-	I1
EU6E-SWD-4DX	24 V	0 V	-	-	I0	-	I2	-	I2	-	I3
EU6E-SWD-4D4D-1	24 V	0 V	-	Q1	Q0	Q3	Q2	I1	I0	I3	I2
EU6E-SWD-4D4D-2	24 V	0 V	-	Q1	Q0	Q3	Q2	I1	I0	I3	I2
EU6E-SWD-4XD-1	24 V	0 V	-	-	Q0	-	Q1	-	Q2	-	Q3
EU6E-SWD-4XD-2	24 V	0 V	-	-	Q0	-	Q1	-	Q2	-	Q3
EU6E-SWD-8DX	24 V	0 V	-	I1	I0	I3	I2	I5	I4	I7	I6
EU6E-SWD-8DD	24 V	0 V	-	I1/Q1	I0/Q0	I3/Q3	I2/Q2	I5/Q5	I4/Q4	I7/Q7	I6/Q6
EU6E-SWD-8XD-1	24 V	0 V	-	Q1	Q0	Q3	Q2	Q5	Q4	Q7	Q6

EU6E-SWD-...-1, ...-2

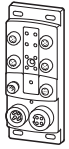

EU8E-SWD-...

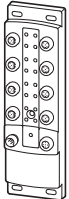

	X1...Xn			X1		X2		X3		X4	
	1	3	5	2	4	2	4	2	4	2	4
EU8E-SWD-4D4D-1	24V	-	-	-	Q0	-	Q1	-	Q2	-	Q3
EU8E-SWD-8XD-1	24V	-	-	-	Q0	-	Q1	-	Q2	-	Q3
EU8E-SWD-8D8D-1	24V	-	-	Q1	Q0	Q3	Q2	Q5	Q4	Q7	Q6
EU8E-SWD-16DD	24V	0V	-	I1/Q1	I0/Q0	I3/Q3	I2/Q2	I5/Q5	I4/Q4	I7/Q7	I6/Q6
EU8E-SWD-16DX	24V	-	-	I1	I0	I3	I2	I5	I4	I7	I6
EU8E-SWD-16XD-1	24V	-	-	Q1	Q0	Q3	Q2	Q5	Q4	Q7	Q6

EU8E-SWD-...-1

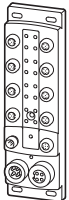

	X5		X6		X7		X8	
	2	4	2	4	2	4	2	4
EU8E-SWD-4D4D-1	-	I0	-	I1	-	I2	-	I3
EU8E-SWD-8XD-1	-	Q4	-	Q5	-	Q6	-	Q7
EU8E-SWD-8D8D-1	I1	I0	I3	I2	I5	I4	I7	I6
EU8E-SWD-16DD	I9/Q9	I8/Q8	I11/Q11	I10/Q10	I13/Q13	I12/Q12	I15/Q15	I14/Q14
EU8E-SWD-16DX	I9	I8	I11	I10	I13	I12	I15	I14
EU8E-SWD-16XD-1	Q9	Q8	Q11	Q10	Q13	Q12	Q15	Q14

07/21 IL120006ZU

