













20 713 819 Product version from 3/13/2017



- 168mm projection
- pivotable spout 360°
- circular, air-enriched flow
- height of mixer 280 mm
- height up to aerator 191 mm
- hole diameter valve 32 mm
- hole diameter spout 35 mm
- rosette Ø 60 mm
- max. flow 5.7 l/min
- lead-free
- This product can help a building meet the requirements of Green Building Rating Systems, e.g. LEED®, BREEAM®, DGNB
- WRAS

Only suitable for basins with an overflow.

	Chrome	20 713 819-00
	Brushed Platinum	20 713 819-06
	Platinum	20 713 819-08
	Dark Chrome	20 713 819-19
	Brushed Durabronze (23kt Gold)	20 713 819-28
	Brushed Gold (PVD)	20 713 819-37
	Brushed Dark Brass (PVD)	20 713 819-39
	Brushed Bronze (PVD)	20 713 819-42
	Brushed Dark Bronze (PVD)	20 713 819-43
	Brushed Champagne (22kt Gold)	20 713 819-46
	Champagne (22kt Gold)	20 713 819-47
	Brushed Dark Platinum	20 713 819-99

Recommended miscellaneous



High pressure hoses - 12 506 970 90
 • 2x 3/8" x 1/2" x 500mm high pressure hose

20 713 819 Product version from 3/13/2017

mm [inches]

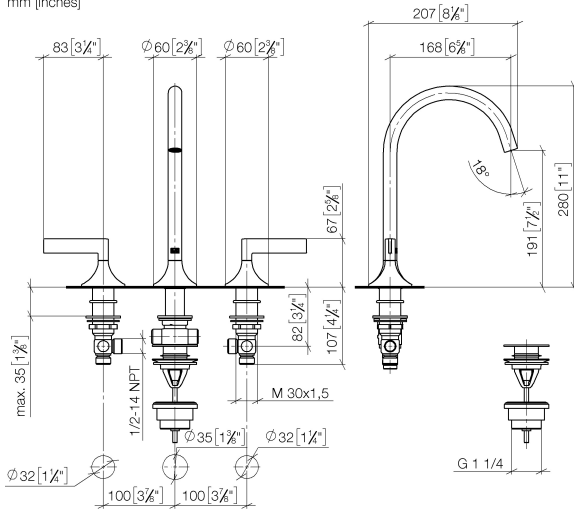

Flow rate chart



Codes & Standards

DIN 4109

Executive Order
no. 1007

ISO 3822

Scottish Water
Byelaws

UK Water Supply
Regulations

Ü-Zeichen

XP P 41-280



VAIA Three-hole basin mixer with pop-up waste - Chrome

VAIA

20 713 819 Product version from 3/13/2017

Certificates and sustainability

WRAS_2312

LGA_29

ACS_20 ACC LY

GDV_0400

EPD-DOR-20230287
-IBA1-EN
Environmental.prod
uct-declarat

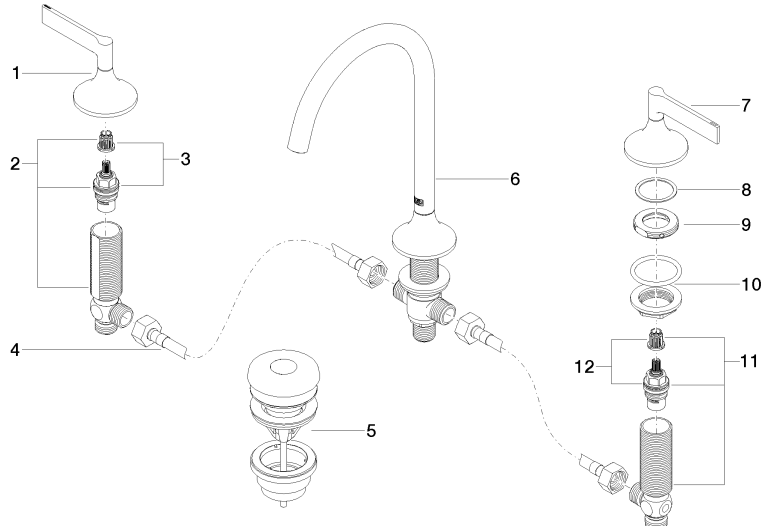

Spare parts list

No.	Item Number	Name	Quantity used	Delivery time
1	90 20 80 013 00-00	Handle for side valve Hot Lever 113 x 68 x 60 mm - Chrome	1.00	20
3	90 90 03 151 00 90	Head part clockwise closing 1/2" -	1.00	14
8	09 28 10 003 90	Washer 39 x 32,5 x1 mm -	2.00	14
12	90 90 03 150 00 90	Head part anti-clockwise closing 1/2" -	1.00	14
9	09 24 01 028 90	Ring Ø 42 x 9 mm -	2.00	14
2	04 17 11 055 51 90	Deck valve clockwise closing 1/2" -	1.00	14
5	10 125 970-00	Basin Waste with push fastening 1 1/4" - Chrome	1.00	14
10	04 23 10 032 46 90	Mounting with seals M30 x 1,5 -	2.00	14
4	04 30 04 096 00 90	High pressure hose with sleeve nut 1/2" x 1/2" x 400 mm -	1.00	14
7	90 20 80 012 00-00	Handle for side valve Cold Lever 113 x 68 x 60 mm - Chrome	1.00	20
11	04 17 11 055 50 90	Deck valve anti-clockwise closing 1/2" -	1.00	14
6	13 716 809-00	VAIA Deck-mounted basin spout without pop-up waste - Chrome	1.00	20