













90 28 22 332 00



	Brushed Bronze (PVD)	90 28 22 332 00-42
	Chrome	90 28 22 332 00-00
	Brushed Platinum	90 28 22 332 00-06
	Platinum	90 28 22 332 00-08
	Durabronze (23kt Gold)	90 28 22 332 00-09
	Dark Chrome	90 28 22 332 00-19
	Brushed Durabronze (23kt Gold)	90 28 22 332 00-28
	Matte Black	90 28 22 332 00-33
	Brushed Champagne (22kt Gold)	90 28 22 332 00-46
	Champagne (22kt Gold)	90 28 22 332 00-47
	Brushed Chrome	90 28 22 332 00-93
	Brushed Dark Platinum	90 28 22 332 00-99



Spout 200 mm - Brushed Bronze (PVD)

SPARE PARTS

90 28 22 332 00



Spout 200 mm - Brushed Bronze (PVD)

SPARE PARTS

90 28 22 332 00

90 28 22 332 00

Parts for other finishes can be found here: [Chrome](#)

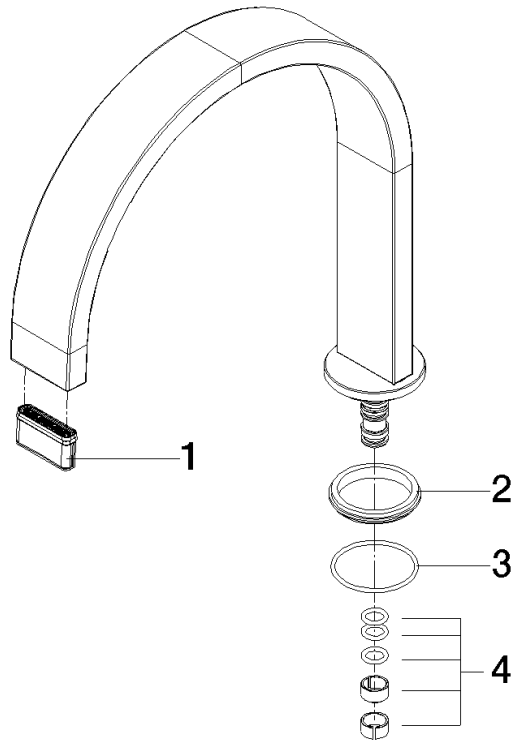

Spare parts list

No.	Item Number	Name	Quantity used	Delivery time
2	90 30 11 285 00 90	Disc Ø 41 x 4,5 mm -	1.00	14
3	90 14 10 500 00 90	O-Ring EPDM 70 34,65 x 1,78 mm -	1.00	14
4	90 28 10 184 00 90	Seal set for spout -	1.00	14
1	90 29 03 045 00 90	Aerator insert without limitation 32 x 8 mm -	1.00	14