







90 28 22 332 01



	Brushed Platinum	90 28 22 332 01-06
	Chrome	90 28 22 332 01-00
	Platinum	90 28 22 332 01-08
	Durabronze (23kt Gold)	90 28 22 332 01-09
	Dark Chrome	90 28 22 332 01-19
	Brushed Durabronze (23kt Gold)	90 28 22 332 01-28
	Matte Black	90 28 22 332 01-33
	Brushed Bronze (PVD)	90 28 22 332 01-42
	Brushed Champagne (22kt Gold)	90 28 22 332 01-46
	Champagne (22kt Gold)	90 28 22 332 01-47
	Brushed Chrome	90 28 22 332 01-93
	Brushed Dark Platinum	90 28 22 332 01-99



Spout 200 mm, 5,68 l/min. - Brushed Platinum

SPARE PARTS

90 28 22 332 01



Spout 200 mm, 5,68 l/min. - Brushed Platinum

SPARE PARTS

90 28 22 332 01

90 28 22 332 01

Parts for other finishes can be found here: [Chrome](#)

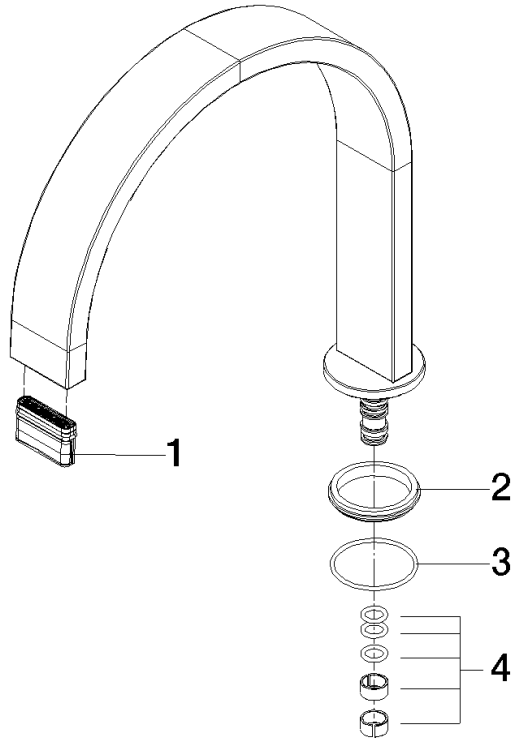

Spare parts list

No.	Item Number	Name	Quantity used	Delivery time
3	90 14 10 500 00 90	O-Ring EPDM 70 34,65 x 1,78 mm -	1.00	14
1	90 29 03 109 00 90	Aerator insert 5,7 l/min. -	1.00	14
4	90 28 10 184 00 90	Seal set for spout -	1.00	14
2	90 30 11 285 00 90	Disc Ø 41 x 4,5 mm -	1.00	14