

## Data Sheet | Item Number: 264-108

2-conductor terminal strip; without push-buttons; with fixing flanges; 8-pole; for screw or similar mounting types; Fixing hole 3.2 mm Ø; 2.5 mm<sup>2</sup>; CAGE CLAMP®; gray

<https://www.wago.com/264-108>

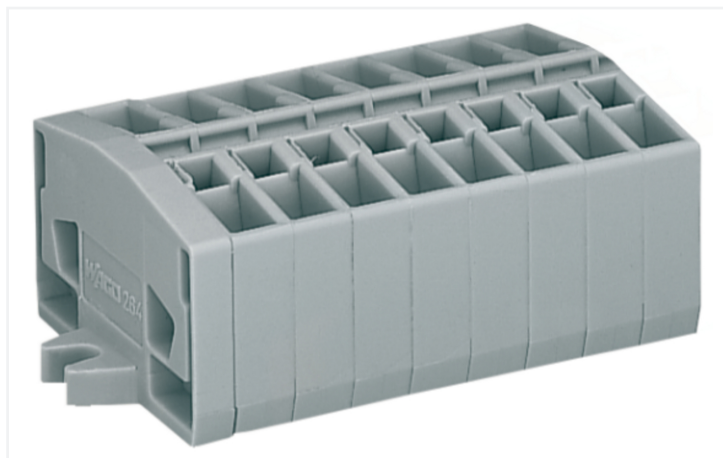

Color: ■ gray

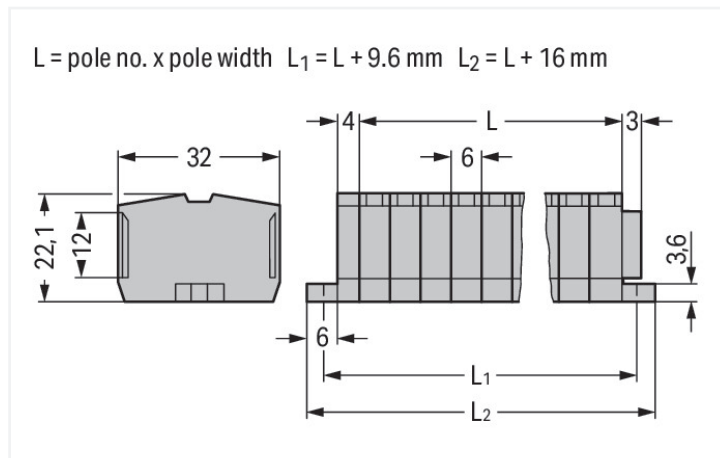

Dimensions in mm

Through terminal block, 264 Series, CAGE CLAMP®

This through terminal block (item number 264-108) streamlines wire connections, making them both quick and easy. Conductors can only be connected to this through terminal block if their strip length is between 8 and 9 mm. Whether in industrial or building applications, our rail-mount through terminal blocks are the perfect solution to quickly and securely connect electrical conductors. Depending on the model, you can use them for either typical through-wiring or potential distribution. This product features conductor terminals and utilizes CAGE CLAMP®. Our highly-rated and maintenance-free CAGE CLAMP® connection makes it easy to connect all conductor types without having to prepare the conductor. For example, you don't need to crimp ferrules. The dimensions are (64 x 32 x 22.1) mm (width x height x depth). This through terminal block is suitable for conductor cross sections ranging from 0.08 mm<sup>2</sup> to 2.5 mm<sup>2</sup>.

This mini rail-mount terminal block is operated with an operating tool.

### Electrical data

#### Ratings per IEC/EN

Nominal voltage (III/3)	800 V
Rated impulse withstand voltage (III / 3)	8 kV
Rated current	24 A
Legend (ratings)	(III / 3) ≙ Overvoltage category III / Pollution degree 3

#### Approvals per

#### UL 1059

Use group	B	C	D
Rated voltage	600 V	600 V	-
Rated current	20 A	20 A	-

#### Approvals per

#### CSA 22.2 No 158

Use group	B	C	D
Rated voltage	-	600 V	-
Rated current	-	20 A	-

#### General information

Wiring direction	Front-entry wiring
------------------	--------------------

### Connection Data

Clamping units	16
Total number of potentials	8
Number of levels	1

### Connection 1

Connection technology	CAGE CLAMP®
Actuation type	Operating tool
Connectable conductor materials	Copper
Solid conductor	0.08 ... 2.5 mm <sup>2</sup> / 28 ... 12 AWG
Fine-stranded conductor	0.08 ... 2.5 mm <sup>2</sup> / 28 ... 12 AWG
Note (conductor cross-section)	12 AWG: THHN, THWN
Strip length	8 ... 9 mm / 0.31 ... 0.35 inches
Pole number	8
Wiring direction	Front-entry wiring

### Physical data

Width	64 mm / 2.52 inches
Height	32 mm / 1.26 inches
Depth	22.1 mm / 0.87 inches
Module width	6 mm / 0.236 inches

### Mechanical data

Design	horizontal type
Mounting type	Mounting flange
Marking level	Center marking

### Material data

Note (material data)	<a href="#">Information on material specifications can be found here</a>
Color	gray
Material group	I
Insulation material (main housing)	Polyamide (PA66)
Flammability class per UL94	V0
Fire load	0.653 MJ
Halogen-free	Yes
Weight	32.4 g

### Commercial data

Product Group	9 (Std Chassis Mt Blocks)
PU (SPU)	50 pcs
Packaging type	Box
Country of origin	DE
GTIN	4044918425872
Customs tariff number	85369010000

### Product Classification

UNSPSC	39121410
eCl@ss 10.0	27-14-11-06
eCl@ss 9.0	27-14-11-06
ETIM 9.0	EC001284
ETIM 10.0	EC001284
ECCN	NO US CLASSIFICATION

### Environmental Product Compliance

RoHS Compliance Status	Compliant, No Exemption
------------------------	-------------------------

### Approvals / Certificates

#### General approvals



Approval	Standard	Certificate Name
CB DEKRA Certification B.V.	EN 60998	NL-49768
CCA DEKRA Certification B.V.	EN 60998	NTR NL-7342
CCA DEKRA Certification B.V.	EN 60998	2175624.01
CSA DEKRA Certification B.V.	C22.2	70010891
UR Underwriters Laboratories Inc.	UL 1059	E45172

#### Declarations of conformity and manufacturer's declarations

Approval	Standard	Certificate Name
EU-Declaration of Conformity WAGO GmbH & Co. KG	-	-
UK-Declaration of Conformity WAGO GmbH & Co. KG	-	-

#### Approvals for marine applications



Approval	Standard	Certificate Name
ABS American Bureau of Shipping	-	24-0095979-PDA
DNV GL Det Norske Veritas, Germanischer Lloyd	-	TAE00001V2
LR Lloyds Register	IEC 60998	LR22173030TA
PRS Polski Rejestr Statków	-	TE/1094/880590/23

**Downloads**

**Environmental Product Compliance**

Compliance Search			
Environmental Product Compliance 264-108			↓

**Documentation**

Bid Text			
264-108	19.02.2019	xml 3.22 KB	↓
264-108	14.06.2017	doc 24.50 KB	↓

**CAD/CAE-Data**

CAD data	
2D/3D Models 264-108	↓

CAE data	
EPLAN Data Portal 264-108	↓
WSCAD Universe 264-108	↓
ZUKEN Portal 264-108	↓

**1 Compatible Products**

**1.1 Optional Accessories**

**1.1.1 Ferrule**

**1.1.1.1 Ferrule**

<p><b>Item No.: 216-131</b>                      Ferrule; Sleeve for 0.25 mm<sup>2</sup> / AWG 24; un-insulated; electro-tin plated; silver-colored</p>	<p><b>Item No.: 216-201</b>                      Ferrule; Sleeve for 0.5 mm<sup>2</sup> / 20 AWG; insulated; electro-tin plated; electrolytic copper; acc. to DIN 46228, Part 4/09.90; white</p>	<p><b>Item No.: 216-101</b>                      Ferrule; Sleeve for 0.5 mm<sup>2</sup> / AWG 22; un-insulated; electro-tin plated; silver-colored</p>	<p><b>Item No.: 216-202</b>                      Ferrule; Sleeve for 0.75 mm<sup>2</sup> / 18 AWG; insulated; electro-tin plated; gray</p>
<p><b>Item No.: 216-102</b>                      Ferrule; Sleeve for 0.75 mm<sup>2</sup> / AWG 20; un-insulated; electro-tin plated; silver-colored</p>	<p><b>Item No.: 216-203</b>                      Ferrule; Sleeve for 1 mm<sup>2</sup> / AWG 18; insulated; electro-tin plated; red</p>	<p><b>Item No.: 216-103</b>                      Ferrule; Sleeve for 1 mm<sup>2</sup> / AWG 18; un-insulated; electro-tin plated</p>	<p><b>Item No.: 216-204</b>                      Ferrule; Sleeve for 1.5 mm<sup>2</sup> / AWG 16; insulated; electro-tin plated; black</p>
<p><b>Item No.: 216-104</b>                      Ferrule; Sleeve for 1.5 mm<sup>2</sup> / AWG 16; un-insulated; electro-tin plated; silver-colored</p>	<p><b>Item No.: 216-205</b>                      Ferrule; Sleeve for 2.08 mm<sup>2</sup> / AWG 14; insulated; electro-tin plated; yellow</p>	<p><b>Item No.: 216-206</b>                      Ferrule; Sleeve for 2.5 mm<sup>2</sup> / AWG 14; un-insulated; electro-tin plated; blue</p>	<p><b>Item No.: 216-106</b>                      Ferrule; Sleeve for 2.5 mm<sup>2</sup> / AWG 14; un-insulated; electro-tin plated; silver-colored</p>

## 1.1.2 Installation

### 1.1.2.1 Cover



**Item No.: 709-153**

Cover; Type 1; suitable for cover carrier, type 1; 1 m long; transparent

### 1.1.2.2 Cover carrier



**Item No.: 709-167**

Cover carrier; Type 1; incl. fixing/retaining screws and knurled nut; suitable for 279 to 282 and 880 Series rail-mounted terminal blocks; suitable for 264 Series miniature rail-mounted terminal blocks; suitable for 270 Series sensor and actuator terminal blocks; gray

## 1.1.3 Jumper

### 1.1.3.1 Jumper



**Item No.: 281-492**

Jumper; 2-way; insulated; gray



**Item No.: 264-402**

Jumper; for conductor entry; 2-way; insulated; gray

## 1.1.4 Marking

### 1.1.4.1 Marker

**Item No.: 2009-145/000-006**

Mini-WSB Inline; for Smart Printer; 1700 pieces on roll; stretchable 5 - 5.2 mm; plain; snap-on type; blue

**Item No.: 2009-145/000-007**

Mini-WSB Inline; for Smart Printer; 1700 pieces on roll; stretchable 5 - 5.2 mm; plain; snap-on type; gray

**Item No.: 2009-145/000-023**

Mini-WSB Inline; for Smart Printer; 1700 pieces on roll; stretchable 5 - 5.2 mm; plain; snap-on type; green

**Item No.: 2009-145/000-012**

Mini-WSB Inline; for Smart Printer; 1700 pieces on roll; stretchable 5 - 5.2 mm; plain; snap-on type; orange

**Item No.: 2009-145/000-005**

Mini-WSB Inline; for Smart Printer; 1700 pieces on roll; stretchable 5 - 5.2 mm; plain; snap-on type; red

**Item No.: 2009-145/000-024**

Mini-WSB Inline; for Smart Printer; 1700 pieces on roll; stretchable 5 - 5.2 mm; plain; snap-on type; violet

**Item No.: 2009-145**

Mini-WSB Inline; for Smart Printer; 1700 pieces on roll; stretchable 5 - 5.2 mm; plain; snap-on type; white

**Item No.: 2009-145/000-002**

Mini-WSB Inline; for Smart Printer; 1700 pieces on roll; stretchable 5 - 5.2 mm; plain; snap-on type; yellow



**Item No.: 248-501/000-006**

Mini-WSB marking card; as card; not stretchable; plain; snap-on type; blue

**Item No.: 248-501/000-007**

Mini-WSB marking card; as card; not stretchable; plain; snap-on type; gray

**Item No.: 248-501/000-023**

Mini-WSB marking card; as card; not stretchable; plain; snap-on type; green

**Item No.: 248-501/000-017**

Mini-WSB marking card; as card; not stretchable; plain; snap-on type; light green



**Item No.: 248-501/000-012**

Mini-WSB marking card; as card; not stretchable; plain; snap-on type; orange

**Item No.: 248-501/000-005**

Mini-WSB marking card; as card; not stretchable; plain; snap-on type; red

**Item No.: 248-501/000-024**

Mini-WSB marking card; as card; not stretchable; plain; snap-on type; violet

**Item No.: 248-501**

Mini-WSB marking card; as card; not stretchable; plain; snap-on type; white



**Item No.: 248-501/000-002**

Mini-WSB marking card; as card; not stretchable; plain; snap-on type; yellow

### 1.1.5 Test and measurement

#### 1.1.5.1 Testing accessories



**Item No.: 249-136**

Test plug module; without locking device; modular; for 2-conductor terminal blocks; gray



**Item No.: 210-136**

Test plug; 2 mm Ø; with 500 mm cable; red

### 1.1.6 Tool

#### 1.1.6.1 Operating tool



**Item No.: 210-658**

Operating tool; Blade: 3.5 x 0.5 mm; with a partially insulated shaft; angled; short; multicoloured



**Item No.: 210-720**

Operating tool; Blade: 3.5 x 0.5 mm; with a partially insulated shaft; multicoloured



**Item No.: 210-657**

Operating tool; Blade: 3.5 x 0.5 mm; with a partially insulated shaft; short; multicoloured



**Item No.: 209-130**

Operating tool; made of insulating material; 1-way; for 264 Series (1-/2-way), 280, 281 Series (up to 3-way); natural

### Installation Notes

#### Installation

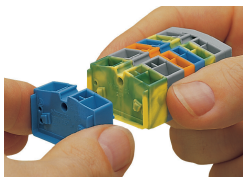

Assembling modular terminal blocks into terminal strips.

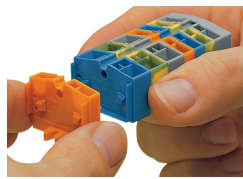

Mounting an "end terminal block" with mounting flange.

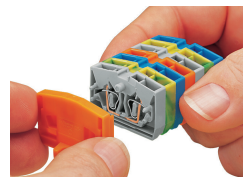

Mounting an end plate.

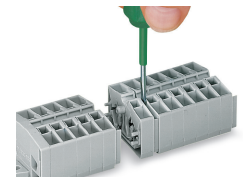

Removing a terminal block.

### Conductor termination



**CAGE CLAMP® connection**

Inserting a conductor. With ferruled conductors, it is necessary to use a terminal block one size smaller than the conductor's nominal cross-section.

### Commoning

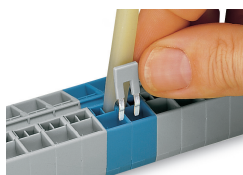

Commoning with comb-style jumper bar.

## Testing

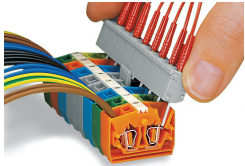

Testing by touch contact to the CAGE CLAMP® spring (limited to 0.5 A and 48 V test voltage) – test pins are not protected against accidental contact.

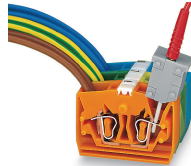

Testing via CAGE CLAMP® on the current bar (max. nominal current: 6 A). CAGE CLAMP® clamps individual test contacts. The maximum test voltage is 400 V.



Terminal strip with mounting flanges:

- End plate with mounting flange
- Center terminal blocks
- End terminal block with mounting flange

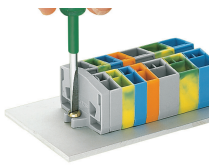

Mounting and securing a terminal strip directly to the plate via screw-type flanges.

## Marking



Marking via Mini-WSB Quick Marking System.