

## Contactstop AM-TOP®

Bestelnr. 299

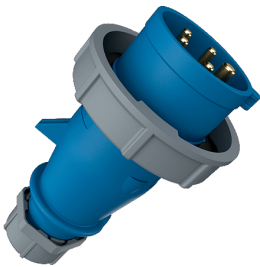

- schroefklemmen
- ééndelige behuizing
- wartel met afdichting
- trekontlasting en knikbescherming

## Technische informatie

Ampère	32 A
Polen	5 p
Voltage	230 V
Uurstand	9 h
Hertz	50-60 Hz
Aansluittechniek	schroefklemmen
Contacten	standaard
Beschermingsgraad	IP 67
Gewicht	329 g
Certificeringen	EAC, CQC

## Tekeningen

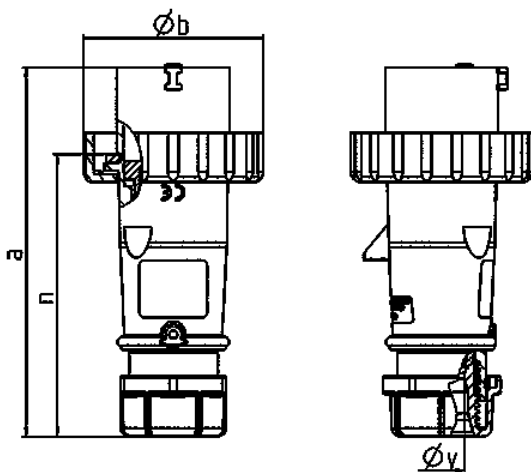

Tekening	Amp. Polen	16			32		
		3	4	5	3	4	5
<b>Maten in mm</b>	<b>a</b>	142	144	147	186	186	180
	<b>b</b>	70	78	87	94	94	101
	<b>n</b>	109	111	114	145	145	138
	<b>y</b>	14,5	16	16	22	22	22
<b>Kabelaansluiting</b>		1	1	1	2,5	2,5	2,5
<b>van/tot mm²</b>		-2,5	-2,5	-2,5	-6	-6	-6