

Strainer waste with control handle - Brushed Dark Platinum

SERIES-VARIOUS













10 712 970 Product version from 10/1/2024

- control for single basin
- including adapter for Bowden cable

Not compatible with brushed stainless steel kitchen sinks 38 XXX 004-86.

Fits ELIO, ENO, MEM, META SQUARE, SYNC and TARA ULTRA



	Brushed Dark Platinum	10 712 970-99
	Chrome	10 712 970-00
	Brushed Platinum	10 712 970-06
	Platinum	10 712 970-08
	Durabass (23kt Gold)	10 712 970-09
	Dark Chrome	10 712 970-19
	Brushed Durabass (23kt Gold)	10 712 970-28
	Matte Black	10 712 970-33
	Brushed Dark Brass (PVD)	10 712 970-39
	Brushed Bronze (PVD)	10 712 970-42
	Brushed Dark Bronze (PVD)	10 712 970-43
	Brushed Champagne (22kt Gold)	10 712 970-46
	Champagne (22kt Gold)	10 712 970-47
	Brushed Chrome	10 712 970-93

10 712 970 Product version from 10/1/2024

mm [inches]

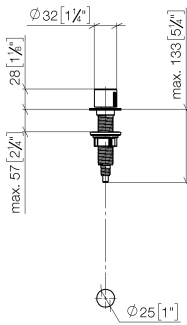

10 712 970 Product version from 10/1/2024

Parts for other finishes can be found here: [Chrome](#)

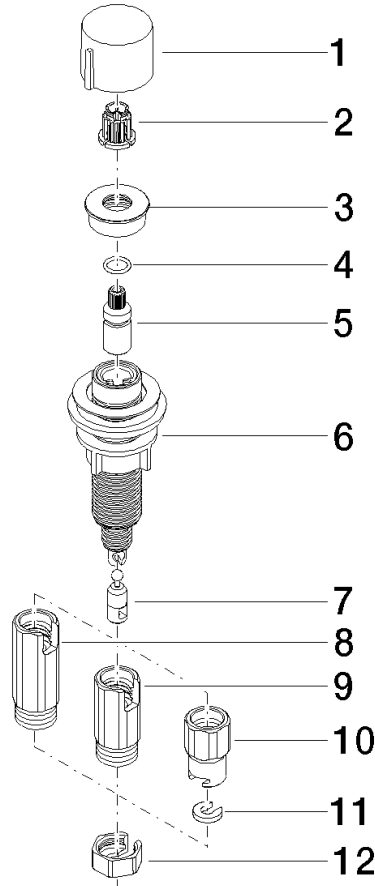

Spare parts list

No.	Item Number	Name	Quantity used	Delivery time
	8 09 11 10 073-07	Connection Ø 20 x 52,5 mm - untreated nickel-plated	1.00	40
	5 09 29 06 087-99	Connection Spindle extension Ø 12 x 31 mm - Brushed Dark Platinum	1.00	-
Spare part can no longer be ordered, please order the replacement item				
	11 09 30 11 087 90	Disc 12,60 x 6,00 x 2,4 mm -	1.00	14
	3 09 27 87 011-99	Rosette Ø 28 x Ø 12,2 x 7 mm - Brushed Dark Platinum	1.00	40
	12 09 23 30 024-07	Mounting for strainer waste set - untreated nickel-plated	1.00	40
	9 09 11 10 074-07	Connection Ø 20 x 42 mm - untreated nickel-plated	1.00	40
	6 04 30 01 029 00 90	Connection for strainer waste activation -	1.00	14
	7 09 24 03 175 90	Connection for strainer waste -	1.00	14
	1 09 20 97 030-99	Handle Ø 31,5 x 25 mm - Brushed Dark Platinum	1.00	40
	10 09 11 10 079-07	Connection Ø 20 x 32 mm - untreated nickel-plated	1.00	40
	4 09 14 10 042 90	O-Ring EPDM 70 9,0 x 1,5 mm -	1.00	14
	2 90 12 12 002 00 90	Fixing cap white Ø 15 x 12 mm -	1.00	14