

ISO-nagelclip, kort model



PP Polypropyleen

Stamgegevens

Artikelnummer	2226308
Type	2018 40 RW
Omschrijving 1	ISO-nagelclip
Fabrikant	OBO
Dimensie	18mm, L40
Kleur	zuiver wit; RAL 9010
Materiaal	Polypropyleen
Kleinste verkoop-eenheid	25
Eenheid van hoeveelheid	Stuk
Gewicht	0,548 kg
Eenheid gewicht	kg/100 st.

Technisch specificatieblad

ISO-nagelclip type 2018, helder wit

Artikelnummer: 2226308



Afmetingen

Maat B	13 mm
Afm. H	22 mm
Maat L	28 mm

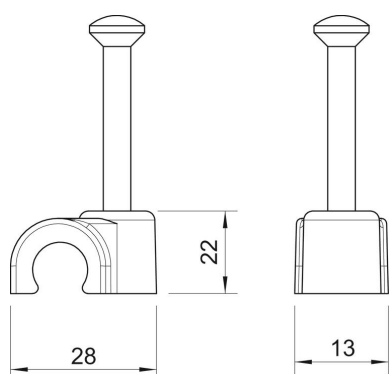
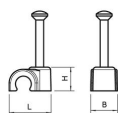
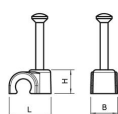

Technisch specificatieblad

ISO-nagelclip type 2018, helder wit

Artikelnummer: 2226308



Technische gegevens

Dubbele klem	nee
Vorm	rond (voor ronde geleider)
voor kabeldiameter	18 mm
voor nageldiameter	2,0x40
Gehard	ja
Halogeenvrij	ja
Met nagel	ja
Nagellengte	40 mm
Slagvast	nee
Buisvergrendeling	nee