

ISO-nagelclip, kort model



PP Polypropyleen

Stamgegevens

Artikelnummer	2226022
Type	2012 35 RW
Omschrijving 1	ISO-nagelclip
Fabrikant	OBO
Dimensie	12mm, L35
Kleur	zuiver wit; RAL 9010
Materiaal	Polypropyleen
Kleinste verkoop-eenheid	100
Eenheid van hoeveelheid	Stuk
Gewicht	0,169 kg
Eenheid gewicht	kg/100 st.

Technisch specificatieblad

ISO-nagelclip type 2012, helder wit

Artikelnummer: 2226022



Afmetingen

Maat B	9 mm
Afm. H	14,8 mm
Maat L	19,8 mm

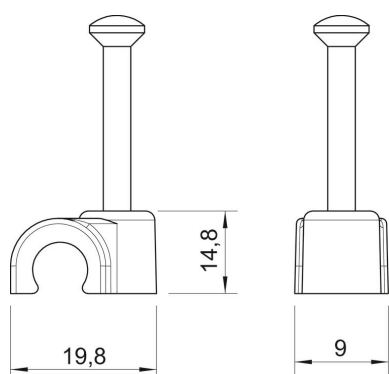

Technisch specificatieblad

ISO-nagelclip type 2012, helder wit

Artikelnummer: 2226022



Technische gegevens

Dubbele klem	nee
Vorm	rond (voor ronde geleider)
voor kabel diameter	12 mm
voor nagel diameter	2,0x35
Gehard	ja
Halogeenvrij	ja
Met nagel	ja
Nagellengte	35 mm
Slagvast	nee
Buisvergrendeling	nee