

Data Sheet | Item Number: 769-219/281-434

1-conductor/1-pin component carrier terminal block; with 2 jumper positions; LED (red); 24 VDC; for DIN-rail 35 x 15 and 35 x 7.5; 4 mm²; CAGE CLAMP®; 4,00 mm²; gray

<https://www.wago.com/769-219/281-434>

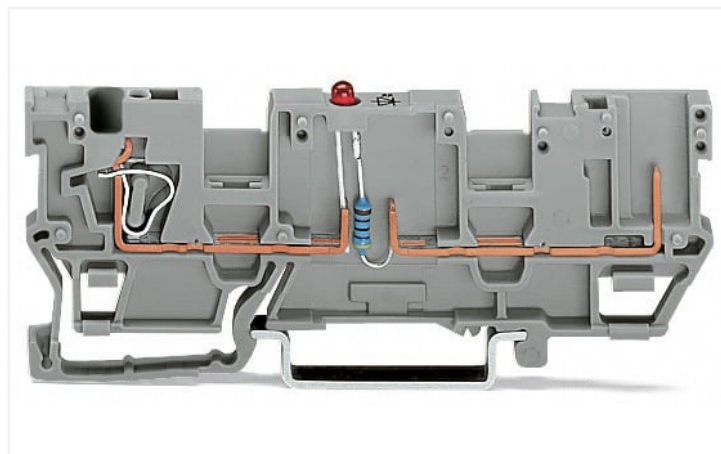
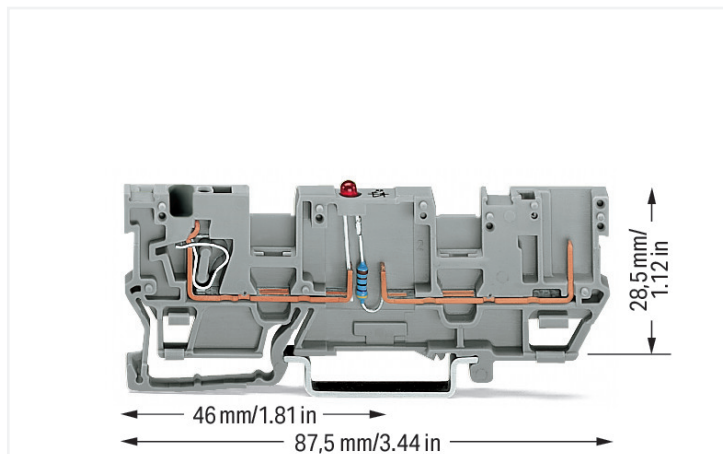

Color: ■ gray

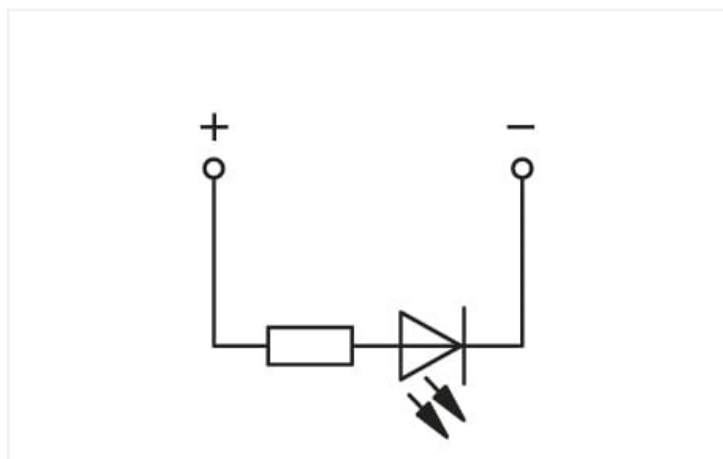

769-219/281-434

Notes

Safety Information

A separator plate (item no. 209-191) or a 10 mm end stop (item no. 249-117) must be placed at the end of a WAGO X-COM®-SYSTEM terminal strip.

Electrical data

Ratings per IEC/EN

Rated current 0.025 A

General information

Voltage type 1 DC
Nominal voltage 24 V

Connection data

Clamping units	1
Total number of potentials	1
Number of levels	1

Connection 1

Connection technology	CAGE CLAMP®
Number of connection points	1
Actuation type	Operating tool
Connectable conductor materials	Copper
Nominal cross-section	4 mm ² / 12 AWG
Solid conductor	0.08 ... 4 mm ² / 28 ... 12 AWG
Fine-stranded conductor	0.08 ... 4 mm ² / 28 ... 12 AWG
Strip length	8 ... 9 mm / 0.31 ... 0.35 inches
Wiring direction	Front-entry wiring

Connection 2

Number of connection points 2	1
-------------------------------	---

Physical data

Width	5 mm / 0.197 inches
Height	87.5 mm / 3.445 inches
Depth from upper-edge of DIN-rail	28.5 mm / 1.122 inches

Mechanical data

Design	horizontal type
Mounting type	DIN-35 rail
Marking level	Center marking

Material data

Note (material data)	Information on material specifications can be found here
Color	gray
Material group	I
Insulation material (main housing)	Polyamide (PA66)
Flammability class per UL94	V0
Fire load	0.161 MJ
Weight	8.2 g

Environmental requirements

Processing temperature	-35 ... +85 °C
Continuous operating temperature	-60 ... +105 °C

Commercial data

Product Group	18 (X-COM-System)
eCl@ss 10.0	27-14-11-27
eCl@ss 9.0	27-14-11-27
ETIM 8.0	EC000903
ETIM 7.0	EC000903
PU (SPU)	50 pcs
Packaging type	Box
Country of origin	DE
GTIN	4050821418849
Customs tariff number	85366990990

Environmental Product Compliance

RoHS Compliance Status	Compliant, No Exemption
------------------------	-------------------------

Approvals / Certificates

General approvals **Declarations of conformity and manufacturer's declarations**



Approval	Standard	Certificate Name
CCA DEKRA Certification B.V.	EN 60947	NTR NL-7626
CSA CSA Group	C22.2	1101144
KEMA/KEUR DEKRA Certification B.V.	EN 60947	2190419.01

Approval	Standard	Certificate Name
EU-Declaration of Conformity WAGO GmbH & Co. KG	-	-
UK-Declaration of Conformity WAGO GmbH & Co. KG	-	-

Approvals for marine applications



Approval	Standard	Certificate Name
ABS American Bureau of Shipping	EN 60947	20-HG1941090-PDA
DNV GL Det Norske Veritas, Germanischer Lloyd	-	TAE00001V2

Downloads

Environmental Product Compliance

Compliance Search	
Environmental Product Compliance 769-219/281-434	↓

Documentation

Additional Information		
Technical Section	pdf 2246.92 KB	↓

Bid Text				
769-219/281-434	19.02.2019	xml 3.26 KB	↓	
769-219/281-434	02.10.2017	doc 25.00 KB	↓	

CAD/CAE-Data

CAD data

2D/3D Models
769-219/281-434 

CAE data

EPLAN Data Portal
769-219/281-434 

WSCAD Universe
769-219/281-434 

ZUKEN Portal
769-219/281-434 

1 Compatible Products

1.1 System counterpart

1.1.1 Female connector/socket



Item No.: 769-101/022-000
1-conductor female connector, angled; CAGE CLAMP®; 4 mm²; Pin spacing 5 mm; 1-pole; coding finger; 4,00 mm²; gray



Item No.: 769-110/145-000
1-conductor female connector; CAGE CLAMP®; 4 mm²; Pin spacing 5 mm; 10-pole; coding finger; Centered locking levers; Strain relief plate; 4,00 mm²; gray



Item No.: 769-111/145-000
1-conductor female connector; CAGE CLAMP®; 4 mm²; Pin spacing 5 mm; 11-pole; coding finger; Centered locking levers; Strain relief plate; 4,00 mm²; gray



Item No.: 769-112/145-000
1-conductor female connector; CAGE CLAMP®; 4 mm²; Pin spacing 5 mm; 12-pole; coding finger; Centered locking levers; Strain relief plate; 4,00 mm²; gray



Item No.: 769-113/145-000
1-conductor female connector; CAGE CLAMP®; 4 mm²; Pin spacing 5 mm; 13-pole; coding finger; Centered locking levers; Strain relief plate; 4,00 mm²; gray



Item No.: 769-114/145-000
1-conductor female connector; CAGE CLAMP®; 4 mm²; Pin spacing 5 mm; 14-pole; coding finger; Centered locking levers; Strain relief plate; 4,00 mm²; gray



Item No.: 769-115/145-000
1-conductor female connector; CAGE CLAMP®; 4 mm²; Pin spacing 5 mm; 15-pole; coding finger; Centered locking levers; Strain relief plate; 4,00 mm²; gray



Item No.: 769-101
1-conductor female connector; CAGE CLAMP®; 4 mm²; Pin spacing 5 mm; 1-pole; coding finger; 4,00 mm²; gray



Item No.: 769-101/141-000
1-conductor female connector; CAGE CLAMP®; 4 mm²; Pin spacing 5 mm; 1-pole; coding finger; Centered locking levers; Strain relief plate; 4,00 mm²; gray



Item No.: 769-102/142-000
1-conductor female connector; CAGE CLAMP®; 4 mm²; Pin spacing 5 mm; 2-pole; coding finger; Centered locking levers; Strain relief plate; 4,00 mm²; gray



Item No.: 769-103/142-000
1-conductor female connector; CAGE CLAMP®; 4 mm²; Pin spacing 5 mm; 3-pole; coding finger; Centered locking levers; Strain relief plate; 4,00 mm²; gray



Item No.: 769-104/143-000
1-conductor female connector; CAGE CLAMP®; 4 mm²; Pin spacing 5 mm; 4-pole; coding finger; Centered locking levers; Strain relief plate; 4,00 mm²; gray



Item No.: 769-105/143-000
1-conductor female connector; CAGE CLAMP®; 4 mm²; Pin spacing 5 mm; 5-pole; coding finger; Centered locking levers; Strain relief plate; 4,00 mm²; gray



Item No.: 769-106/144-000
1-conductor female connector; CAGE CLAMP®; 4 mm²; Pin spacing 5 mm; 6-pole; coding finger; Centered locking levers; Strain relief plate; 4,00 mm²; gray



Item No.: 769-107/144-000
1-conductor female connector; CAGE CLAMP®; 4 mm²; Pin spacing 5 mm; 7-pole; coding finger; Centered locking levers; Strain relief plate; 4,00 mm²; gray



Item No.: 769-108/144-000
1-conductor female connector; CAGE CLAMP®; 4 mm²; Pin spacing 5 mm; 8-pole; coding finger; Centered locking levers; Strain relief plate; 4,00 mm²; gray



Item No.: 769-109/144-000
1-conductor female connector; CAGE CLAMP®; 4 mm²; Pin spacing 5 mm; 9-pole; coding finger; Centered locking levers; Strain relief plate; 4,00 mm²; gray



Item No.: 769-121
2-conductor female connector; CAGE CLAMP®; 4 mm²; Pin spacing 5 mm; 1-pole; coding finger; 4,00 mm²; gray

1.2 Required Accessories

1.2.1 End plate

1.2.1.1 End plate



Item No.: 769-311
End and intermediate plate; 1.1 mm thick; gray



Item No.: 769-312
End and intermediate plate; 1.1 mm thick; orange

1.3 Optional Accessories

1.3.1 Coding

1.3.1.1 Coding



Item No.: 769-435
Coding pin; for coding of female plugs; for carrier terminal blocks / male connectors; orange

1.3.2 Cover

1.3.2.1 Cover



Item No.: 769-438
Pin cover; with marker slot for miniature WSB; gray



Item No.: 769-439
Pin cover; with marker slot for miniature WSB; orange

1.3.3 DIN-rail

1.3.3.1 Mounting accessories



Item No.: 210-196
Aluminum carrier rail; 35 x 8.2 mm; 1.6 mm thick; 2 m long; unslotted; similar to EN 60715; silver-colored



Item No.: 210-198
Copper carrier rail; 35 x 15 mm; 2.3 mm thick; 2 m long; unslotted; according to EN 60715; copper-colored



Item No.: 210-508
Steel carrier rail; 35 x 15 mm; 1.5 mm thick; 2 m long; slotted; galvanized; similar to EN 60715; silver-colored



Item No.: 210-197
Steel carrier rail; 35 x 15 mm; 1.5 mm thick; 2 m long; slotted; similar to EN 60715; silver-colored



Item No.: 210-506
Steel carrier rail; 35 x 15 mm; 1.5 mm thick; 2 m long; unslotted; galvanized; similar to EN 60715; silver-colored



Item No.: 210-114
Steel carrier rail; 35 x 15 mm; 1.5 mm thick; 2 m long; unslotted; similar to EN 60715; silver-colored



Item No.: 210-118
Steel carrier rail; 35 x 15 mm; 2.3 mm thick; 2 m long; unslotted; according to EN 60715; silver-colored



Item No.: 210-115
Steel carrier rail; 35 x 7.5 mm; 1 mm thick; 2 m long; slotted; according to EN 60715; "Hole width 18 mm; silver-colored



Item No.: 210-112
Steel carrier rail; 35 x 7.5 mm; 1 mm thick; 2 m long; slotted; according to EN 60715; "Hole width 25 mm; silver-colored



Item No.: 210-504
Steel carrier rail; 35 x 7.5 mm; 1 mm thick; 2 m long; slotted; galvanized; according to EN 60715; silver-colored



Item No.: 210-113
Steel carrier rail; 35 x 7.5 mm; 1 mm thick; 2 m long; unslotted; according to EN 60715; silver-colored



Item No.: 210-505
Steel carrier rail; 35 x 7.5 mm; 1 mm thick; 2 m long; unslotted; galvanized; according to EN 60715; silver-colored

1.3.4 End plate

1.3.4.1 End plate



Item No.: 769-314

Separator plate; 1.1 mm thick; oversized; orange

1.3.5 Ferrule

1.3.5.1 Ferrule



Item No.: 216-301

Ferrule; Sleeve for 0.25 mm² / AWG 24; insulated; electro-tin plated; yellow



Item No.: 216-302

Ferrule; Sleeve for 0.34 mm² / 22 AWG; insulated; electro-tin plated; light turquoise



Item No.: 216-201

Ferrule; Sleeve for 0.5 mm² / 20 AWG; insulated; electro-tin plated; white



Item No.: 216-101

Ferrule; Sleeve for 0.5 mm² / AWG 22; un-insulated; electro-tin plated; silver-colored



Item No.: 216-202

Ferrule; Sleeve for 0.75 mm² / 18 AWG; insulated; electro-tin plated; gray



Item No.: 216-102

Ferrule; Sleeve for 0.75 mm² / AWG 20; un-insulated; electro-tin plated; silver-colored



Item No.: 216-203

Ferrule; Sleeve for 1 mm² / AWG 18; insulated; electro-tin plated; red



Item No.: 216-103

Ferrule; Sleeve for 1 mm² / AWG 18; un-insulated; electro-tin plated



Item No.: 216-204

Ferrule; Sleeve for 1.5 mm² / AWG 16; insulated; electro-tin plated; black



Item No.: 216-104

Ferrule; Sleeve for 1.5 mm² / AWG 16; un-insulated; electro-tin plated; silver-colored



Item No.: 216-206

Ferrule; Sleeve for 2.5 mm² / AWG 14; insulated; electro-tin plated; blue

1.3.6 Installation

1.3.6.1 Mounting accessories



Item No.: 209-106

Mounting carrier; for isolated mounting on DIN 35 rails; gray



Item No.: 249-116

Screwless end stop; 6 mm wide; for DIN-rail 35 x 15 and 35 x 7.5; gray

1.3.7 Insulation stop

1.3.7.1 Insulation stop



Item No.: 769-470

Insulation stop; 0.08 - 0.2 mm² "s" (0.14 mm² "f-st"); 5 pieces/strip; white



Item No.: 769-471

Insulation stop; 0.25 - 0.5 mm²; 5 pieces/strip; light gray



Item No.: 769-472

Insulation stop; 0.75 - 1 mm²; 5 pieces/strip; dark gray

1.3.8 Jumper

1.3.8.1 Jumper



Item No.: 280-402

Jumper; insulated; gray

Item No.: 280-409

Jumper; insulated; gray

Item No.: 780-452

Staggered jumper; from 1 to 2; insulated; gray

Item No.: 780-453

Staggered jumper; from 1 to 3; insulated; gray



Item No.: 780-454

Staggered jumper; from 1 to 4; insulated; gray

Item No.: 780-455

Staggered jumper; from 1 to 5; insulated; gray

Item No.: 780-456

Staggered jumper; from 1 to 6; insulated; gray

Item No.: 780-457

Staggered jumper; from 1 to 7; insulated; gray



Item No.: 780-458

Staggered jumper; from 1 to 8; insulated; gray

1.3.9 Marking

1.3.9.1 Marker



Item No.: 2009-145

Mini-WSB Inline; for Smart Printer; 1700 pieces on roll; stretchable 5 - 5.2 mm; plain; snap-on type; white

Item No.: 248-501

Mini-WSB marking card; as card; not stretchable; plain; snap-on type; white

1.3.10 Protective warning marker

1.3.10.1 Cover



Item No.: 280-415

Protective warning marker; for 5 terminal blocks; with high-voltage symbol, black; yellow

1.3.11 Push-in type wire jumper

1.3.11.1 Jumper



Item No.: 249-126

Push-in type wire jumper; 0.75 mm²; insulated; 110 mm long; black

Item No.: 249-123

Push-in type wire jumper; 0.75 mm²; insulated; 180 mm long; black

Item No.: 249-127

Push-in type wire jumper; 0.75 mm²; insulated; 250 mm long; black

Item No.: 249-125

Push-in type wire jumper; insulated; 60 mm long; black

1.3.12 Test and measurement

1.3.12.1 Testing accessories



Item No.: 280-419

Spacer module; modular; bridging commoned terminal blocks; gray



Item No.: 280-404

Test plug adapter; 5 mm wide; for test plug (2.3 mm Ø); suitable for 1.5 mm² - 4 mm² tbs; gray



Item No.: 280-418

Test plug module; modular; suitable for all WAGO 280 and 780 Series rail-mounted terminal blocks with jumper slots in the current bar; gray



Item No.: 210-136

Test plug; 2 mm Ø; with 500 mm cable; red

1.3.13 Tool

1.3.13.1 Operating tool



Item No.: 210-720

Operating tool; Blade: 3.5 x 0.5 mm; with a partially insulated shaft; multicoloured

Installation Notes

Installation

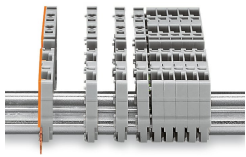

Snap individual carrier terminal blocks onto the DIN-rail and slide together.

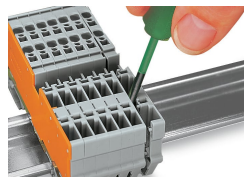

Open the assembly by laterally sliding a block via operating tool and remove terminal block via release lever.

Conductor termination

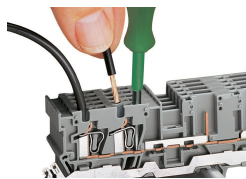

CAGE CLAMP® connection

Carrier terminal block: Insert/remove conductor via operating tool (3.5 x 0.5 mm blade).

Commoning

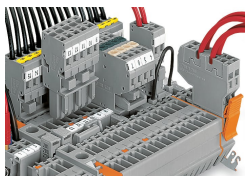

Commoning with adjacent or staggered jumpers. Push jumpers down until fully inserted.

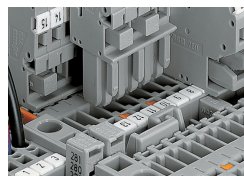

Commoning carrier terminal blocks via staggered jumpers.

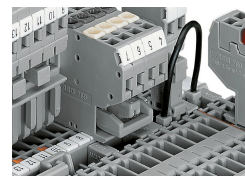

Commoning a 2-conductor female plug via staggered jumper and carrier terminal blocks via adjacent jumpers.

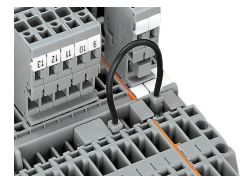

Commoning carrier terminal blocks via push-in type wire jumpers or adjacent jumpers – even over an intermediate plate.

Commoning

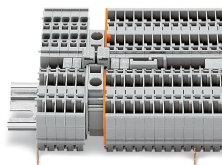

Commoning "supply terminal blocks" (up to 10 mm²/8 AWG) with carrier terminal blocks via step-down jumpers.

Coding

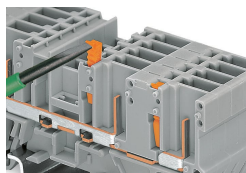

Snap coding pin in proper direction on carrier terminal block.
Shown: Coding pin removal from carrier terminal block.

Locking system

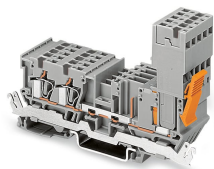

Securing a female plug via locking lever on the terminal block side.