

Data Sheet | Item Number: 261-256/332-000

4-conductor terminal strip; on one side with push-buttons; with snap-in mounting feet; 6-pole; for plate thickness 0.6 - 1.2 mm; Fixing hole 3.5 mm Ø; 2.5 mm²; CAGE CLAMP®; 2,50 mm²; gray

<https://www.wago.com/261-256/332-000>

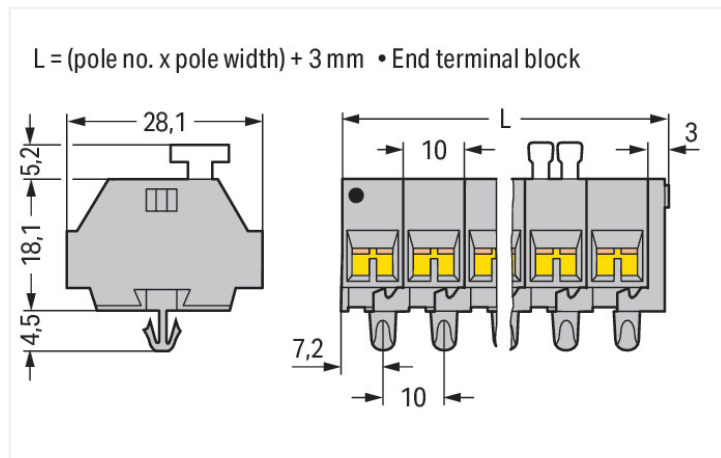
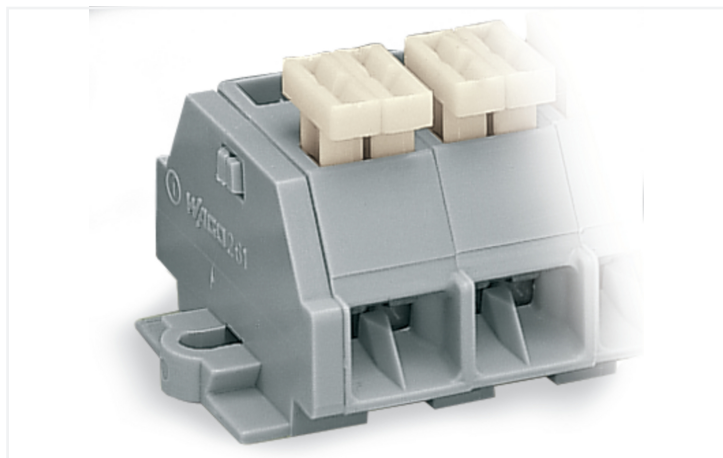

Color: ■ gray

Similar to illustration

Dimensions in mm

Through terminal block, 261 Series, Push-button

This through terminal block (item number 261-256/332-000) streamlines wire connections, making them both quick and easy. Conductors should only be connected to this through terminal block if their strip length is between 8 and 9 mm. Our mini rail-mount terminal blocks are perfect for tight spaces thanks to their compact design. You can also choose from a range of mounting and actuation variants, making it easy to select the ideal mini terminal block for each use. Featuring conductor terminals along with CAGE CLAMP®, this connector is highly versatile. Our CAGE CLAMP® connection provides a safe and maintenance-free way to connect all types of conductors. You do not need to prepare the conductor in any way, such as crimping ferrules. Dimensions: (63 x 28 x 27.7) mm (width x height x depth). Depending on the type of conductor, this through terminal block is suitable for conductor cross sections ranging from 0.08 mm² to 2.5 mm².

This mini rail-mount terminal block is operated with operating tool, push-button.

Electrical data

Ratings per IEC/EN

Nominal voltage (III/3)	500 V
Rated impulse withstand voltage (III / 3)	6 kV
Rated current	24 A
Legend (ratings)	(III / 3) ≙ Overvoltage category III / Pollution degree 3

Approvals per

UL 1059

Use group	B	C	D
Rated voltage	300 V	300 V	600 V
Rated current	15 A	15 A	5 A

Approvals per

CSA 22.2 No 158

Use group	B	C	D
Rated voltage	-	300 V	600 V
Rated current	-	10 A	5 A

General information

Wiring direction Side-entry wiring

Connection Data

Clamping units	24
Total number of potentials	6
Number of levels	1

Connection 1

Connection technology	CAGE CLAMP®
Actuation type	Operating tool
Connectable conductor materials	Copper
Solid conductor	0.08 ... 2.5 mm ² / 28 ... 14 AWG
Fine-stranded conductor	0.08 ... 2.5 mm ² / 28 ... 14 AWG
Strip length	8 ... 9 mm / 0.31 ... 0.35 inches
Pole number	6
Wiring direction	Side-entry wiring

Connection 2

Actuation type	Push-button
----------------	-------------

Physical data

Width	63 mm / 2.48 inches
Height	28 mm / 1.102 inches
Height from the surface	23.3 mm / 0.917 inches
Depth	27.7 mm / 1.091 inches
Module width	10 mm / 0.394 inches

Mechanical data

Design	horizontal type
Mounting type	Snap-in foot
Marking level	Side marking

Material data

Note (material data)	Information on material specifications can be found here
Color	gray
Material group	I
Insulation material (main housing)	Polyamide (PA66)
Flammability class per UL94	V0
Fire load	0.531 MJ
Halogen-free	Yes
Weight	26.3 g

Commercial data

PU (SPU)	50 pcs
Packaging type	Box
Country of origin	DE
GTIN	4044918628242
Customs tariff number	85369010000

Product Classification

UNSPSC	39121410
eCl@ss 10.0	27-14-11-06
eCl@ss 9.0	27-14-11-06
ETIM 9.0	EC001284
ETIM 10.0	EC001284
ECCN	NO US CLASSIFICATION

Environmental Product Compliance

RoHS Compliance Status	Compliant, No Exemption
------------------------	-------------------------

Approvals / Certificates

General approvals			Declarations of conformity and manufacturer's declarations		
Approval	Standard	Certificate Name	Approval	Standard	Certificate Name
CCA DEKRA Certification B.V.	EN 60998	NTR-NL 6509	EU-Declaration of Conformity WAGO GmbH & Co. KG	-	-
KEMA/KEUR DEKRA Certification B.V.	EN 60998	2110272.02	UK-Declaration of Conformity WAGO GmbH & Co. KG	-	-

Approvals for marine applications

Approval	Standard	Certificate Name
 ABS American Bureau of Shipping	-	24-0095979-PDA

Downloads

Environmental Product Compliance

Compliance Search	
Environmental Product Compliance 261-256/332-000	↓

Documentation

Bid Text			
261-256/332-000	19.02.2019	xml 3.15 KB	↓
261-256/332-000	17.08.2017	doc 25.50 KB	↓

CAD/CAE-Data

CAD data

2D/3D Models
261-256/332-000 

CAE data

EPLAN Data Portal
261-256/332-000 

WSCAD Universe
261-256/332-000 

ZUKEN Portal
261-256/332-000 

1 Compatible Products

1.1 Optional Accessories

1.1.1 DIN-rail

1.1.1.1 Mounting accessories



Item No.: 210-154
Aluminum carrier rail; 1000 mm long; 18 mm wide; 7 mm high; silver-colored

1.1.2 Ferrule

1.1.2.1 Ferrule



Item No.: 216-301
Ferrule; Sleeve for 0.25 mm² / AWG 24; insulated; electro-tin plated; yellow



Item No.: 216-302
Ferrule; Sleeve for 0.34 mm² / 22 AWG; insulated; electro-tin plated; light turquoise



Item No.: 216-201
Ferrule; Sleeve for 0.5 mm² / 20 AWG; insulated; electro-tin plated; electrolytic copper; acc. to DIN 46228, Part 4/09.90; white



Item No.: 216-101
Ferrule; Sleeve for 0.5 mm² / AWG 22; un-insulated; electro-tin plated; silver-colored



Item No.: 216-202
Ferrule; Sleeve for 0.75 mm² / 18 AWG; insulated; electro-tin plated; gray



Item No.: 216-102
Ferrule; Sleeve for 0.75 mm² / AWG 20; un-insulated; electro-tin plated; silver-colored



Item No.: 216-203
Ferrule; Sleeve for 1 mm² / AWG 18; insulated; electro-tin plated; red



Item No.: 216-103
Ferrule; Sleeve for 1 mm² / AWG 18; un-insulated; electro-tin plated



Item No.: 216-204
Ferrule; Sleeve for 1.5 mm² / AWG 16; insulated; electro-tin plated; black



Item No.: 216-104
Ferrule; Sleeve for 1.5 mm² / AWG 16; un-insulated; electro-tin plated; silver-colored



Item No.: 216-205
Ferrule; Sleeve for 2.08 mm² / AWG 14; insulated; electro-tin plated; yellow



Item No.: 216-206
Ferrule; Sleeve for 2.5 mm² / AWG 14; insulated; electro-tin plated; blue



Item No.: 216-106
Ferrule; Sleeve for 2.5 mm² / AWG 14; un-insulated; electro-tin plated; silver-colored

1.1.3 Installation

1.1.3.1 Mounting accessories



Item No.: 209-137

Mounting adapter; can be used as end stop; 6.5 mm wide; gray

Item No.: 209-120

Mounting foot; can be snapped on terminal blocks with snap-in mounting foot; for mounting on relay-modules; 6.4 mm wide; gray

1.1.4 Jumper

1.1.4.1 Jumper



Item No.: 261-402

Jumper; for conductor entry; 2-way; insulated; gray

1.1.5 Marking

1.1.5.1 Marking strip



Item No.: 210-833

Marking strips; 25 m on roll; 6 mm wide; plain; Self-adhesive; white

1.1.6 Tool

1.1.6.1 Operating tool



Item No.: 210-658

Operating tool; Blade: 3.5 x 0.5 mm; with a partially insulated shaft; angled; short; multicoloured

Item No.: 210-720

Operating tool; Blade: 3.5 x 0.5 mm; with a partially insulated shaft; multicoloured

Item No.: 210-657

Operating tool; Blade: 3.5 x 0.5 mm; with a partially insulated shaft; short; multicoloured

Installation Notes

Conductor termination

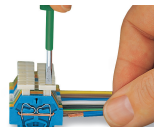
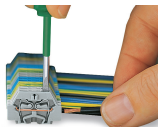

CAGE CLAMP® connection

Inserting a conductor.
With ferruled conductors, it is necessary to use a terminal block one size larger than the conductor's nominal cross-section.

CAGE CLAMP® connection

Inserting a conductor via push-button.

Commoning



Commoning with comb-style jumper bar.

Installation



Mounting a terminal strip with snap-in feet into holes.



Mounting a terminal strip with snap-in feet onto aluminum rail.

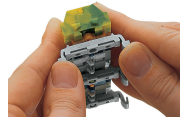

Terminal strip with snap-in mounting feet
Snapping a mounting foot (209-120).
(Distance between mounting feet: approx. 25 ... 30 mm)

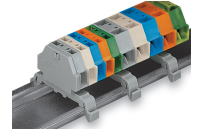

Terminal strip; with snap-in mounting feet; for DIN-35 rail



Terminal strip with snap-in mounting feet, for 0.6 ... 1.2 mm plate thickness, 3.5 mm mounting hole diameter (also for 210-154 Aluminum Rail or with 209-120 Mounting Foot for DIN-35 rail)

Marking

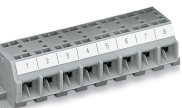

Marking with self-adhesive marking strips.



Marking by direct printing (upon request).