

Data Sheet | Item Number: 733-102/037-000

1-conductor female connector; CAGE CLAMP®; 0.5 mm²; Pin spacing 2.5 mm; 2-pole; 100% protected against mismatching; Lateral locking levers; 0,50 mm²; light gray

<https://www.wago.com/733-102/037-000>



Color: ■ light gray

Similar to illustration

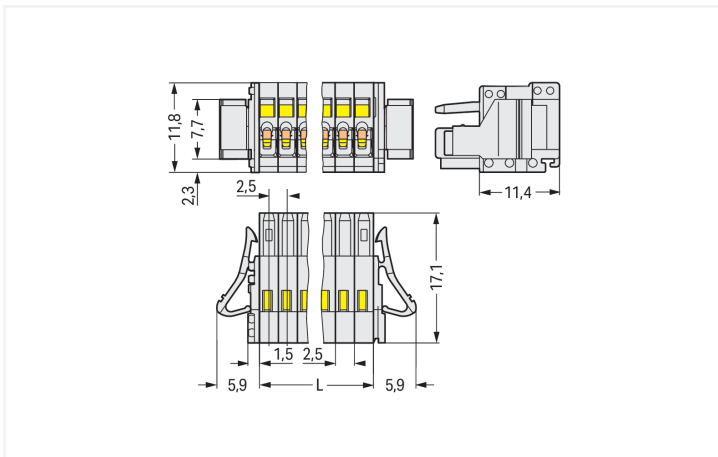
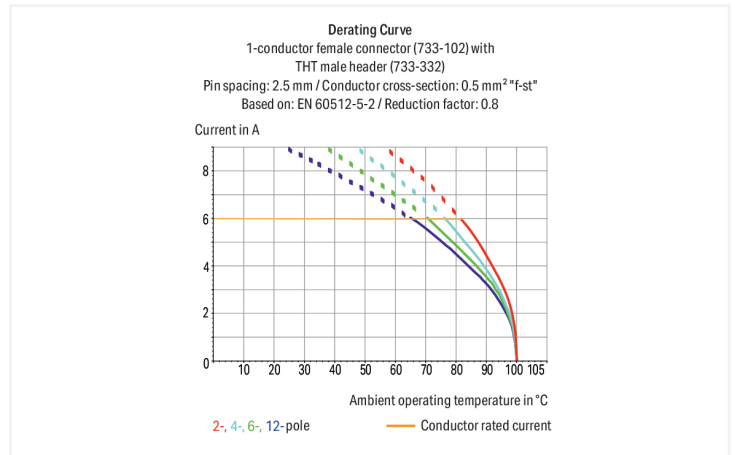

Dimensions in mm

L = pole no. x pin spacing

Female connector, 733 Series, 0° conductor exit to connection direction

Enjoy fault-free electrical installations with this female connector (item number 733-102/037-000). Ensure that the strip lengths are between 5 and 6 mm when connecting conductors to this female connector. This product features one conductor terminal and utilizes CAGE CLAMP®. Our CAGE CLAMP® connection provides a dependable and maintenance-free way to connect all types of conductors. You do not need to prepare the conductor in any way, such as crimping ferrules. Dimensions: (16.8 x 11.8 x 17.1) mm (width x height x depth). This female connector is suitable for conductor cross sections ranging from 0.08 mm² to 0.5 mm².

The contact surface is coated with tin.

Notes

Safety Information

The MCS – MULTI CONNECTION SYSTEM includes connectors without breaking capacity in accordance with DIN EN 61984. When used as intended, these connectors must not be connected/disconnected when live or under load. When used as intended, these connectors must not be connected/disconnected when live or under load. The circuit design should ensure header pins, which can be touched, are not live when unmated.

Variants:

Other pole numbers
Gold-plated or partially gold-plated contact surfaces
Other versions (or variants) can be requested from WAGO Sales or configured at <https://configurator.wago.com/>.

Electrical data

Ratings per		IEC/EN 60664-1			Approvals per		UL 1059		
Overvoltage category		III	III	II	Use group		B	C	D
Pollution degree		3	2	2	Rated voltage		150 V	-	-
Nominal voltage		100 V	160 V	320 V	Rated current		4 A	-	-
Rated impulse withstand voltage		2.5 kV	2.5 kV	2.5 kV					
Rated current		6 A	6 A	6 A					

Approvals per		CSA		
Use group		B	C	D
Rated voltage		150 V	-	-
Rated current		4 A	-	-

Connection Data

Clamping units	2	Connection 1		
Total number of potentials	2	Connection technology	CAGE CLAMP®	
Number of connection types	1	Actuation type	Operating tool	
Number of levels	1	Actuation direction 1	Operation parallel to conductor entry	
		Actuation direction 2	Operation perpendicular to conductor entry	
		Solid conductor	0.08 ... 0.5 mm ² / 28 ... 20 AWG	
		Fine-stranded conductor	0.08 ... 0.5 mm ² / 28 ... 20 AWG	
		Fine-stranded conductor; with insulated ferrule	0.25 ... 0.34 mm ²	
		Fine-stranded conductor; with uninsulated ferrule	0.25 ... 0.34 mm ²	
		Strip length	5 ... 6 mm / 0.2 ... 0.24 inches	
		Pole number	2	
		Conductor entry direction to mating direction	0°	

Physical data

Pin spacing	2.5 mm / 0.098 inches
Width	16.8 mm / 0.661 inches
Height	11.8 mm / 0.465 inches
Depth	17.1 mm / 0.673 inches

Mechanical data

Variable coding	Yes
Anti-rotation protection	Yes

Plug-in connection

Contact type (pluggable connector)	Female connector/socket
Connector (connection type)	for conductor
Mismating protection	Yes
Locking of plug-in connection	Locking lever

Material data

Note (material data)	Information on material specifications can be found here
Color	light gray
Material group	I
Insulation material (main housing)	Polyamide (PA66)
Flammability class per UL94	V0
Clamping spring material	Chrome-nickel spring steel (CrNi)
Contact material	Copper alloy
Contact Plating	Tin
Fire load	0.032 MJ
Weight	1.4 g

Environmental requirements

Limit temperature range	-60 ... +100 °C
Processing temperature	-35 ... +60 °C

Environmental Testing

Test specification: Railway applications – Rolling stock – Electronic equipment	DIN EN 50155 (VDE 0115-200):2022-06
Test procedure: Railway applications – Rolling stock equipment – Vibration and shock tests	DIN EN 61373 (VDE 0115-0106):2011-04
Spectrum/Mounting location	Service life test, Category 1, Class A/B
Functional test with noise-like oscillations	Test passed according to Section 8 of the standard
Frequency	$f_1 = 5 \text{ Hz}$ to $f_2 = 150 \text{ Hz}$
Acceleration	0.101g (highest test level used for all axes)
Test duration per axis	10 min.
Test directions	X, Y and Z axes
Monitoring of contact faults and interruptions	Passed
Voltage drop measurement before and after each axis	Passed
Simulated service life test through increased levels of noise-like oscillations	Test passed according to Section 9 of the standard
Frequency	$f_1 = 5 \text{ Hz}$ to $f_2 = 150 \text{ Hz}$
Acceleration	0.572g (highest test level used for all axes)
Test duration per axis	5 h
Test directions	X, Y and Z axes
Extended testing: Monitoring of contact faults and interruptions	Passed
Extended testing: Voltage drop measurement before and after each axis	Passed
Shock test	Test passed according to Section 10 of the standard
Shock pulse form	Half sine

Environmental Testing

Acceleration	5g (highest test level used for all axes)
Shock duration	30 ms
Number of shocks (per axis)	3 pos. und 3 neg.
Test directions	X, Y and Z axes
Extended testing: Monitoring of contact faults and interruptions	Passed
Extended testing: Voltage drop measurement before and after each axis	Passed
Vibration and shock stress for rolling stock equipment	Passed

Commercial data

Product Group	3 (Multi Conn. System)
PU (SPU)	100 pcs
Packaging type	Box
Country of origin	DE
GTIN	4066966003314
Customs tariff number	85366990990

Product Classification

UNSPSC	39121409
eCl@ss 10.0	27-44-03-09
eCl@ss 9.0	27-44-03-09
ETIM 9.0	EC002638
ETIM 10.0	EC002638
ECCN	NO US CLASSIFICATION

Environmental Product Compliance

RoHS Compliance Status	Compliant, No Exemption
------------------------	-------------------------

Approvals / Certificates

Declarations of conformity and manufacturer's declarations

Approvals for marine applications



Approval	Standard	Certificate Name
Railway WAGO GmbH & Co. KG	-	Railway Ready



Approval	Standard	Certificate Name
BV Bureau Veritas S.A.	IEC 60998	11915/E0 BV

Downloads

Environmental Product Compliance

Compliance Search			
Environmental Product Compliance			↓
733-102/037-000			

Documentation

Additional Information			
Technical Section	03.04.2019	pdf 2027.26 KB	↓

CAD/CAE-Data

CAD data	
2D/3D Models	↓
733-102/037-000	

CAE data	
EPLAN Data Portal	↓
733-102/037-000	

ZUKEN Portal	↓
733-102/037-000	

1 Compatible Products

1.1 System counterpart

1.1.1 Male connector/plug



Item No.: 733-202
1-conductor male connector; CAGE CLAMP®; 0.5 mm²; Pin spacing 2.5 mm; 2-pole; 100% protected against mismatching; light gray

Item No.: 733-362
THT male header; 0.8 x 0.8 mm solder pin; angled; 100% protected against mismatching; Pin spacing 2.5 mm; 2-pole; light gray

Item No.: 733-332
THT male header; 0.8 x 0.8 mm solder pin; straight; 100% protected against mismatching; Pin spacing 2.5 mm; 2-pole; light gray

1.2 Optional Accessories

1.2.1 Ferrule

1.2.1.1 Ferrule



Item No.: 216-301
Ferrule; Sleeve for 0.25 mm² / AWG 24; insulated; electro-tin plated; yellow

Item No.: 216-321
Ferrule; Sleeve for 0.25 mm² / AWG 24; insulated; electro-tin plated; yellow

Item No.: 216-151
Ferrule; Sleeve for 0.25 mm² / AWG 24; uninsulated; electro-tin plated

Item No.: 216-131
Ferrule; Sleeve for 0.25 mm² / AWG 24; uninsulated; electro-tin plated; silver-colored



Item No.: 216-302
Ferrule; Sleeve for 0.34 mm² / 22 AWG; insulated; electro-tin plated; light turquoise

Item No.: 216-322
Ferrule; Sleeve for 0.34 mm² / 22 AWG; insulated; electro-tin plated; light turquoise

Item No.: 216-132
Ferrule; Sleeve for 0.34 mm² / AWG 24; uninsulated; electro-tin plated

Item No.: 216-152
Ferrule; Sleeve for 0.34 mm² / AWG 24; uninsulated; electro-tin plated

1.2.2 Marking

1.2.2.1 Marking strip



Item No.: [210-331/250-202](#)

Marking strips; as a DIN A4 sheet; MARKED; 1-16 (400x); Height of marker strip: 2.3 mm/0.091 in; Strip length 182 mm; Horizontal marking; Self-adhesive; white



Item No.: [210-331/250-207](#)

Marking strips; as a DIN A4 sheet; MARKED; 1-48 (100x); Height of marker strip: 2.3 mm/0.091 in; Strip length 182 mm; Horizontal marking; Self-adhesive; white



Item No.: [210-331/250-204](#)

Marking strips; as a DIN A4 sheet; MARKED; 17-32 (400x); Height of marker strip: 2.3 mm/0.091 in; Strip length 182 mm; Horizontal marking; Self-adhesive; white



Item No.: [210-331/250-206](#)

Marking strips; as a DIN A4 sheet; MARKED; 33-48 (400x); Height of marker strip: 2.3 mm/0.091 in; Strip length 182 mm; Horizontal marking; Self-adhesive; white

1.2.3 Strain relief

1.2.3.1 Strain relief plate

Item No.: [734-127](#)

Strain relief plate; for female and male connectors; 6 mm wide; 1 part; Pin spacing 3.5 mm; light gray

1.2.4 Test and measurement

1.2.4.1 Testing accessories



Item No.: [735-500](#)

WAGO Test pin; 1 mm Ø; 30 V AC / 60 V DC; CAT0; 1 A; 6 mm uninsulated; Test lead for soldering up to 0,5mm²

1.2.5 Tool

1.2.5.1 Operating tool



Item No.: [210-719](#)

Operating tool; Blade: 2.5 x 0.4 mm; with a partially insulated shaft



Item No.: [210-251](#)

Operating tool; for MCS MICRO and MINI with CAGE CLAMP® connection; yellow



Item No.: [233-335](#)

Operating tool; green



Item No.: [233-331](#)

Operating tool; insulated; yellow



Item No.: [733-130](#)

Operating tool; made of insulating material; 1-way; loose; white



Item No.: [733-191](#)

Operating tool; made of insulating material; 1-way; loose; yellow



Item No.: [233-332](#)

Operating tool; made of insulating material; white

Installation Notes

Mismatching protection



Male headers and female connectors are 100% protected against mismatching. Only mating halves with the same pole number can be connected.

Conductor termination

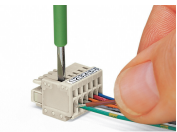

Inserting conductor via (2.5 x 0.4) mm screwdriver – CAGE CLAMP® actuation perpendicular to conductor entry.

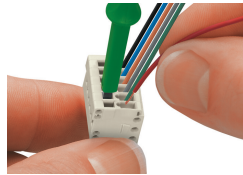

Conductor termination via screwdriver (233-335) – parallel to CAGE CLAMP® actuation

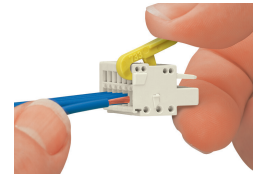
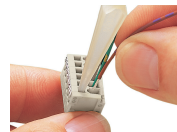

Conductor termination via operating tool (733-191)

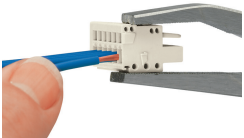

Conductor termination via operating tool (210-251)

Coding



Coding a female connector – removing coding finger(s).

Marking



Strain relief

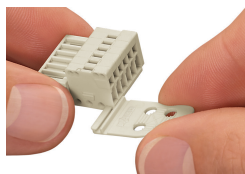

Strain relief plates for factory or in-the-field assembly

Testing



Testing via 1 mm Ø test pin (735-500), touch contact.

Locking system



Locking levers prevent accidental disconnection.

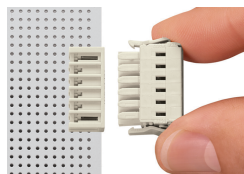

Locking levers prevent accidental disconnection.