

Data Sheet | Item Number: 2773-402

PUSH WIRE® splicing connector; for solid and stranded conductors; max. 4 mm²; 2-conductor; transparent housing; white cover; Surrounding air temperature: max 85°C (T85); 4,00 mm²; transparent

<https://www.wago.com/2773-402>



Color: transparent

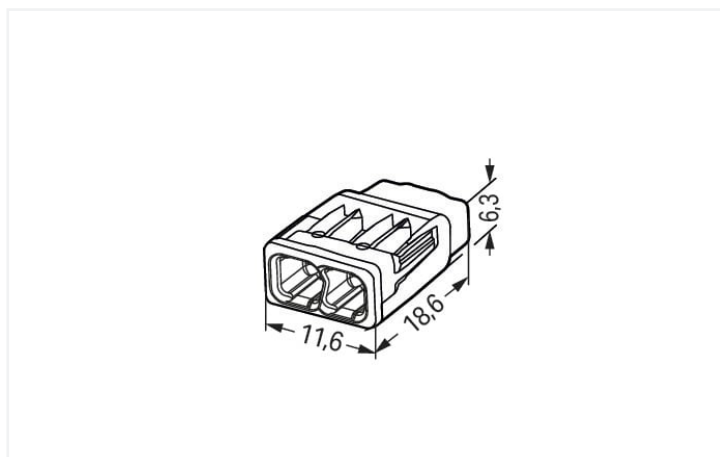
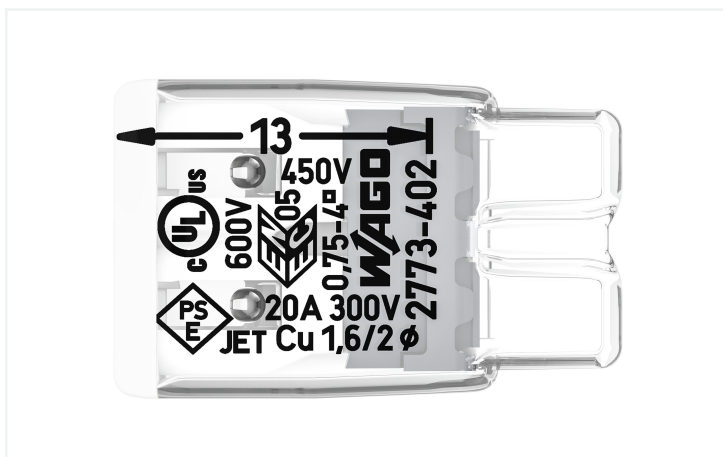
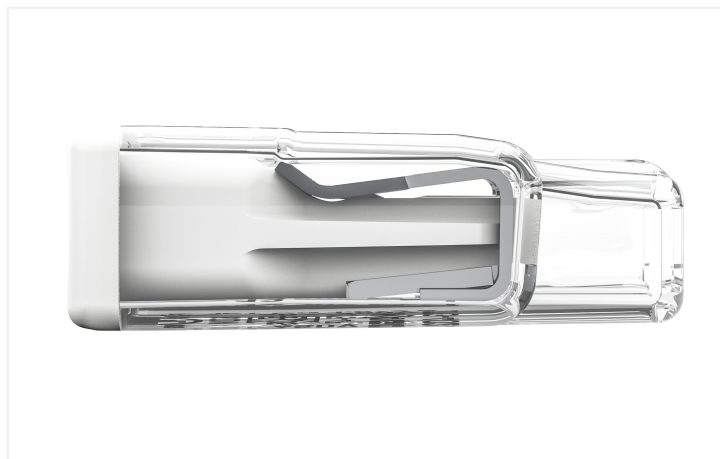

Dimensions in mm

Advantages:

- Convenient wiring via extremely compact design
- Push-in termination of up to eight solid and stranded conductors
- Conductor range: 0.75 ... 4 mm² "s" and 1.5 ... 4 mm² "st"
- Any combination of conductor sizes is possible
- PUSH WIRE® connection terminates solid ("s+str") copper conductors

Notes

Safety management note

NOTICE: Observe installation and safety instructions!

- **Only to be used by electricians!**
- Do not work under voltage/load!
- Use only for proper use!
- Observe national regulations/standards/guidelines!
- Observe technical specifications for the products!
- Observe the number of permissible potentials!
- Do not use damaged/dirty components!
- Observe conductor types, cross-sections and strip lengths!
- Insert conductor until it hits the product's backstop!
- Use original accessories!

To be sold only with installation instructions!

Electrical data

Ratings per	IEC/EN 60998			Approvals per	UL 486C		
Overvoltage category	III	III	II	Use group	B	C	D
Pollution degree	3	2	2	Rated voltage	-	600 V	-
Nominal voltage	-	-	450 V	Rated current	-	20 A	-
Rated surge voltage	-	-	4 kV				
Rated current	-	-	32 A				

Connection data

Clamping units	2	Connection 1	
Total number of potentials	1	Connection technology	PUSH WIRE®
		Actuation type	Push-in
		Connectable conductor materials	Copper
		Solid conductor	0.75 ... 4 mm ² / 20 ... 12 AWG
		Stranded conductor	1.5 ... 4 mm ² / 18 ... 12 AWG
		Conductor diameter	1.6 ... 2 mm / 20 ... 12 AWG
		Strip length	13 mm / 0.51 inches
		Wiring direction	Side-entry wiring

Physical data

Width	11.6 mm / 0.457 inches
Height	6.3 mm / 0.248 inches
Depth	18.6 mm / 0.732 inches

Material data

Note (material data)	Information on material specifications can be found here
Color	transparent
Cover color	white
Material group	IIIa
Insulation material (main housing)	Polycarbonate (PC)
Flammability class per UL94	V2
Clamping spring material	Chrome-nickel spring steel (CrNi)
Contact material	Electrolytic copper (E _{Cu})
Contact Plating	Tin
Fire load	0.021 MJ
Weight	1.1 g

Environmental requirements

Ambient temperature (operation)	+85 °C
Processing temperature	-35 ... +60 °C
Continuous operating temperature	-40 ... +105 °C
Temperature marking per EN 60998	T85

Commercial data

ETIM 8.0	EC000446
ETIM 7.0	EC000446
PU (SPU)	1200 (120) pcs
Packaging type	Box
Country of origin	DE
GTIN	4055143895408
Customs tariff number	85369010000

Environmental Product Compliance

RoHS Compliance Status	Compliant, No Exemption
------------------------	-------------------------

Approvals / Certificates

General approvals



Approval	Standard	Certificate Name
CB DEKRA Certification B.V.	IEC 60998	NL-86543
ENEC 05 DEKRA Certification B.V.	EN 60998	71-127515
KEMA/KEUR DEKRA Certification B.V.	EN 60669	71-101844
UL_Listed_667F Underwriters Laboratories Inc.	UL 486C	E69654
UL Underwriters Laboratories Inc.	UL 467	20180215-E201573

Declarations of conformity and manufacturer's declarations

Approval	Standard	Certificate Name
EU-Declaration of Conformity WAGO GmbH & Co. KG	-	-
UK-Declaration of Conformity WAGO GmbH & Co. KG	-	-

Downloads

Environmental Product Compliance

Compliance Search

Environmental Product Compliance 2773-402	↓
---	-------------------

CAD/CAE-Data

CAD data

2D/3D Models
2773-402



1 Compatible Products

1.1 Optional Accessories

1.1.1 General accessories

1.1.1.1 Moisture protection



Item No.: 207-1332

Gelbox; Branch; for cables; with gel; 221, 2x73 Series; max. 4 mm² connectors; without splicing connectors; Size 2; gray



Item No.: 207-1333

Gelbox; Branch; for cables; with gel; 221, 2x73 Series; max. 4 mm² connectors; without splicing connectors; Size 3; gray

1.1.2 Mounting adapter

1.1.2.1 Mounting accessories



Item No.: 2773-500

Mounting carrier; for single- and double-row con.; 2773 Series; for DIN-35 rail mounting/screw mounting; orange

Installation Notes

Conductor termination



Strip solid or stranded conductor to 13 mm (0.51 inch).



The transparent housing shows if conductors are fully inserted; within the colored base, a clear port shows if the conductor's strip length is correct. Conductors are correctly stripped if the clear port shows no bare conductor on the unprinted connector side. Picture shows center conductor with exceeded strip length.

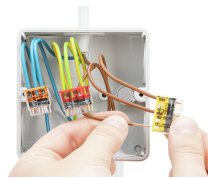

Termination: Insert the stripped conductor until it hits the backstop.

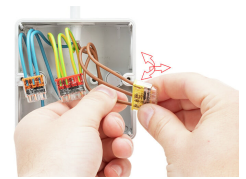

Removal: Hold solid conductor to be removed and twist alternately left and right while pulling the connector.

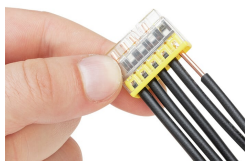

Solid conductors are inserted into the connector by simply pushing them in.



Stranded conductors are inserted into the connector by simply pushing them in.

Testing



Testing via test port opposite to conductor entry.

Application

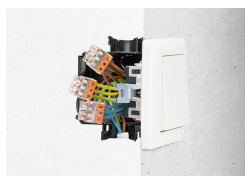

Thanks to their flat and compact design, these connectors are ideal for wiring in flush-mount switch boxes.



With six variants, always have the right connector.