

Data Sheet | Item Number: 272-133/106-000

Power supply connector; without push-buttons; with snap-in mounting feet; without ground contact; 3-pole; 2,50 mm²; white

<https://www.wago.com/272-133/106-000>



Color: ■ white

Similar to illustration

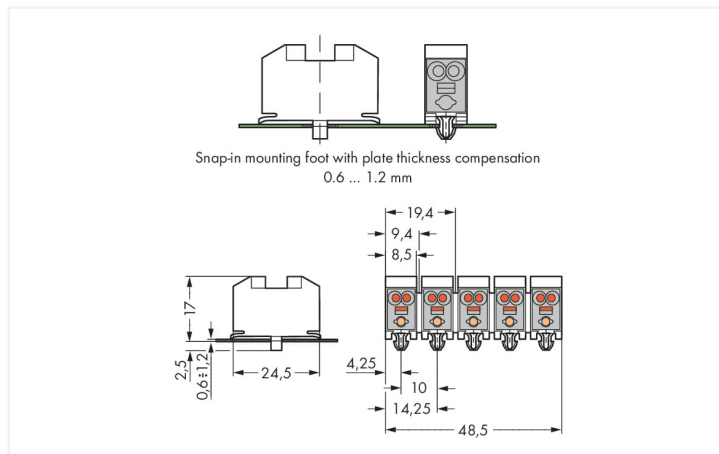

Dimensions in mm

Electrical data

Ratings per	IEC/EN 60664-1		
Overvoltage category	III	III	II
Pollution degree	3	2	2
Nominal voltage	-	400 V	-
Rated surge voltage	-	4 kV	-
Rated current	-	18 A	-

Connection data

Clamping units	12
Total number of potentials	3
Number of connection types	1

Connection 1

Connection technology	PUSH WIRE®
Strip length	8 ... 9 mm / 0.31 ... 0.35 inches
Pole number	3

Physical data

Width	28.5 mm / 1.122 inches
Height	19.5 mm / 0.767 inches
Depth	24.5 mm / 0.965 inches

Material data

Note (material data)

[Information on material specifications can be found here](#)

Color	white
Material group	I
Insulation material (main housing)	Polyamide (PA66)
Flammability class per UL94	V0
Fire load	0.227 MJ
Weight	10.2 g

Commercial data

Product Group	8 (Misc. Chassis Mount Blocks)
eCl@ss 10.0	27-14-11-04
eCl@ss 9.0	27-14-11-04
ETIM 8.0	EC000446
ETIM 7.0	EC000446
PU (SPU)	500 pcs
Packaging type	Bag
GTIN	4044918429771

Environmental Product Compliance

RoHS Compliance Status	Compliant, No Exemption
------------------------	-------------------------

Approvals / Certificates

General approvals



Approval	Standard	Certificate Name
CSA DEKRA Certification B.V.	C22.2 No. 158	70048844

Downloads

Environmental Product Compliance

Compliance Search
Environmental Product Compliance 272-133/106-000



Documentation

Additional Information

Technical Section	03.04.2019	pdf 2027.26 KB	
-------------------	------------	-------------------	--

1 Compatible Products

1.1 Optional Accessories

1.1.1 Tool

1.1.1.1 Operating tool



Item No.: 271-120

Push-button; white