

Productinformatieblad

Specificaties



Harmony XAL-E - Lege drukknopkast - 2 boorgaten - IP54 - Lichtgrijs

XALE2

EAN Code: 3389119017589

Prijs: 20,00 EUR

Hoofd

range of product	Harmony XALE
product of component type	Leeg controlestation
device short name	XALE
bestemming product	Voor XB7-besturings- en signaleringseenheden Ø 22 mm
aantal uitsnijdingen	2 uitsnijdingen
kleur behuizingsbasis	Lichtgrijs (RAL 7035)
kleur deksel	Lichtgrijs (RAL 7035)
materiaal	ABS (acrylonitrile butadiene-styrene)
ingang kabel	2 uitbreekopeningen, klemvermogen: 20 mm 6 uitbreekopeningen voor ISO M20
verkoop per ondeelbare hoeveelheid	5
IP beschermingsgraad	IP54 In overeenstemming met IEC 60529

Complementair

montage stijl	Voor klantassemblage
gewicht product	0,1 kg
markering	CE

Omgeving

beschermende behandeling	TC
ambient air temperature for storage	-40...70 °C
omgevingstemperatuur voor werking	-25...55 °C
beschermingsklasse tegen elektrische schokken	Klasse II In overeenstemming met IEC 60536
IK-beschermingsgraad	IK05 In overeenstemming met IEC 62262
standards	IEC 60947-1 IEC 60947-5-1 IEC 62208 IEC 60947-5-5

Verpakkingseenheid

Eenheidstype van verpakking 1	PCE
Aantal eenheden in verpakking 1	1
verpakking 1 hoogte	6,500 cm

De weergegeven prijs is de adviesprijs in euro excl. BTW. Deze kan onderhevig zijn aan korting. Neem contact op met uw lokale distributeur of detailhandel voor de daadwerkelijke prijs

verpakking 1 breedte	7,500 cm
verpakking 1 lengte	11,500 cm
verpakking_1_gewicht	94,000 g
Eenheidstype van verpakking 2	BB1
Aantal eenheden in verpakking 2	5
verpakking 2 hoogte	8,300 cm
verpakking 2 breedte	12,500 cm
verpakking 2 lengte	33,300 cm
verpakking 2 gewicht	553,000 g
Eenheidstype van verpakking 3	S03
Aantal eenheden in verpakking 3	30
verpakking_3_hoogte	30,000 cm
verpakking 3 breedte	30,000 cm
verpakking 3 lengte	40,000 cm
verpakking 3 gewicht	3,741 kg

contractuele waarborg

Garantie (in maanden)	18
-----------------------	----

Schneider Electric wil tegen 2050 de Net Zero-status hebben bereikt via partnerschappen in de toeleveringsketen, materialen met een lagere impact en circulariteit via onze doorlopende campagne "Use Better, Use Longer, Use Again" om de levensduur van producten en de recycleerbaarheid te verlengen.

[Uitleg van Environmental Data >](#)

[Hoe evalueren we de duurzaamheid van producten? >](#)

Milieuoetafdruk

Totale levenscyclus ecologische voetafdruk	0.8 kg CO2 eq.
Koolstofvoetafdruk van de fabricagefase [A1–A3]	0.7 kg CO2 eq.
Koolstofvoetafdruk van de distributiefase [A4]	0 kg CO2 eq.
Koolstofvoetafdruk van de installatiefase [A5]	0 kg CO2 eq.
Koolstofvoetafdruk van de gebruiksfase [B2, B3, B4, B6]	0 kg CO2 eq.
Koolstofvoetafdruk van de einde-levensfase [C1–C4]	0 kg CO2 eq.
Milieu Profiel	Milieuprofiel van het product

Use Better

Materialen en verpakking

Pakket met gerecycleerd karton	Nee
Verpakkingen zonder kunststof	Nee
RoHS-richtlijn van de EU	Conform
REACH-verordening	Referentie bevat geen SVHC boven drempelwaarde

Use Longer

Levensduurverlenging

Reparatie	Nee
-----------	-----

Use Again

Herverpakken en herfabriceren

Circulair Profiel	Informatie over einde levensduur
Terugname	Ja

Dimensions Drawings

Dimensions

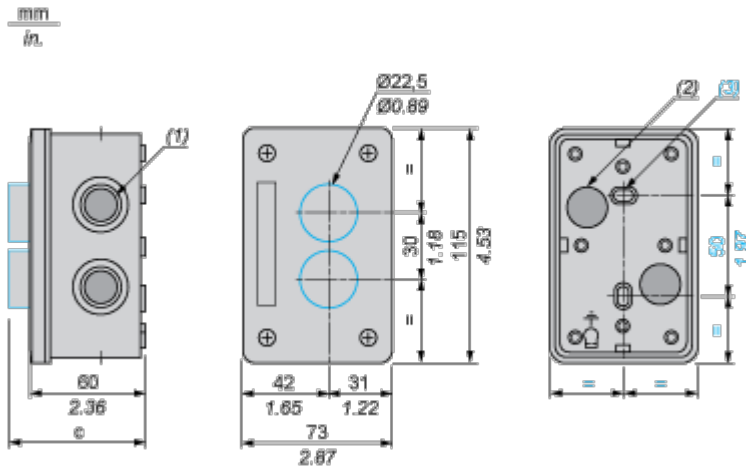







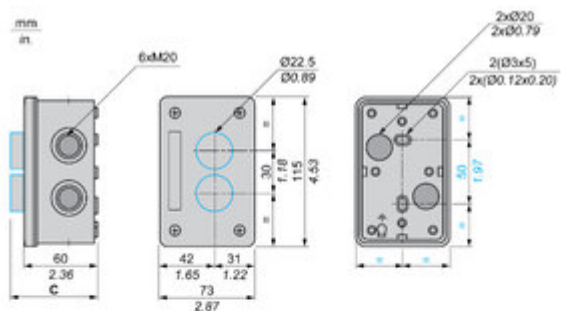

- (1) 6 ISO 20 knock-outs.
- (2) 2 knock-outs for cable entry, maximum capacity 20 mm / 0.79 in.
- (3) 2 knock-out elongated fixing holes $\varnothing 3$ mm x 5 mm / $\varnothing 0.12$ in. x 0.20 in.

Control station XALE fitted with:	c in mm	c in in.
Flush pushbutton	69	2.72
Projecting pushbutton	71	2.79
Illuminated pushbutton	74.5	2.93
Pilot light	71	2.79
Emergency stop without key	89.5	3.52
Selector switch with standard handle	84.5	3.33
Key switch	100	3.94

Technical Illustration

Dimensions



	C	mm	in.
	XB7NA•, XB7NH•	69	2.72
	XB7NL•	71	2.79
	XB7NJ•, XB7NW•	74.5	2.93
	XB7EV•	71	2.79
	XB7NS•, XB7ES•	89.5	3.52
	XB7ND•	84.5	3.33
	XB7NG•	100	3.94

Offer Marketing Illustration

Product benefits / Features

Technical Benefits

Harmony XALE

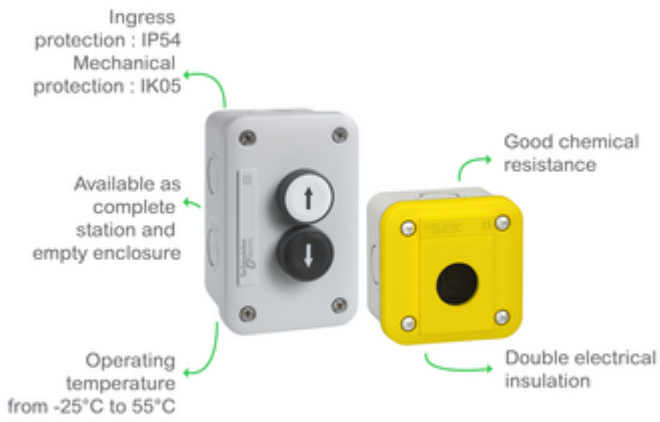



Offer Marketing Illustration

Product benefits / Features

Features
Harmony XALE



 Empty enclosures with 1, 2 or 3 cut-outs fitting all Harmony XB7 units

 Constructed from ABS material

 Designed to meet the needs of users with a quick and simple installation

 Sleek surface that simplifies the cleaning process

Image of product / Alternate images

Alternative





