

Connector

Part number: 688A



MENNEKES
Elektrotechnik GmbH & Co. KG

Aloys-Mennekes-Straße 1
57399 Kirchhundem
GERMANY

www.MENNEKES.org

Product Description

- screw connection technology
- protection against kinking
- strain relief

Technical Details

Connector	688A
Ampere	16A
Number of poles	3p
Nominal voltage AC	20 - 25V
Nominal frequency	50 - 60 Hz
Protection type IP	IP44
Contact carrier	standard
X-CONTACT	no
Connection	screw terminals
Contact screw drive	PZ2, slot
Recommended wire end treatment for supply cable connection terminal	ferrule square gasproof crimped
Pilot contact	without pilot contact
Conductor cross-section min.	4 mm ²
Conductor cross-section max.	10 mm ²
Cable kink protection	with cable kink protection
Protective grommet	without protective grommet
Weight (net)	205 g
Packaging unit	10 pcs
EAN / identification number	4015394005247

Permissible ambient conditions

	Min.	Max.
Permanent ambient temperature	-25 °C	40 °C

Material properties

Front part	PA6 purple [similar RAL 4001]
Housing	PC/PET light grey [similar RAL 7035]
Hinged lid	PA6 purple [similar RAL 4001]

Material resistance

The material resistance overview can be found on the website in the section “Knowledge” - “Product knowledge” - “Materials”.

Material and enviromental properties

RoHS 2011/65/EU incl. 2015/863/EU	✓
POP regulation (EU) 2019/1021	✓

Regulations and Standards

Norm	DIN EN IEC 60309-2
Declaration of Conformity	CE
Test label	EAC

Dimensional Drawing

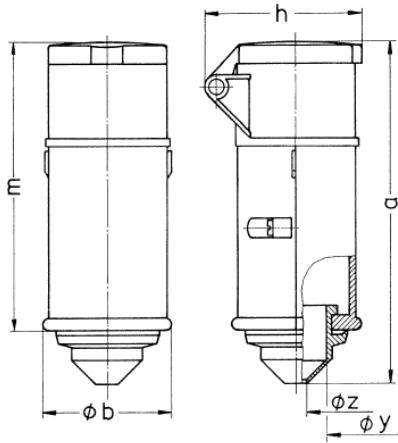

Drawing	Amp. Poles	16		32	
		2	3	2	3
3 MB 37					
Dim. in mm	a	144	144	144	144
	b	55	55	55	55
	h	67	67	67	67
	m	122	122	122	122
	y	25	25	25	25
	z	9	9	9	9
Terminal for cond. cross		4	4	4	4
section (mm ²) min.-max.		—10	—10	—10	—10