

Connector PowerTOP Xtra

Part number: 14111



MENNEKES
Elektrotechnik GmbH & Co. KG

Aloys-Mennekes-Straße 1
57399 Kirchhundem
GERMANY

www.MENNEKES.org

Product Description

- economic enclosure design with nubbed grip areas
- enclosure with thread lock and safety slide
- X-CONTACT
- frame terminals
- protection against kinking
- strain relief
- rubberised cable gland with sealing

Technical Details

Connector PowerTOP Xtra	14111
Product serie	PowerTOP Xtra
Ampere	63A
Number of poles	5p
Clock position	9h
Nominal voltage AC	230V
Nominal frequency	50 - 60 Hz
Protection type IP	IP54
Contact carrier	standard
X-CONTACT	yes
Connection	frame terminals
Contact screw drive	PZ2, slot
Tightening torque connection terminal	2 Nm
Recommended wire end treatment for supply cable connection terminal	usable with and without ferrule
Strip length jacket	80 mm
Strip length conductor PH + N	18 mm
Strip length conductor PE	18 mm
Pilot contact	without pilot contact
Conductor cross-section min.	6 mm ²
Conductor cross-section max.	16 mm ²
Cable kink protection	integrated in cable gland
Protective grommet	without protective grommet

Connector PowerTOP Xtra	14111
Weight (net)	798 g
Packaging unit	5 pcs
EAN / identification number	4015394238157

Permissible ambient conditions

	Min.	Max.
Permanent ambient temperature	-25 °C	40 °C

Material properties

Cover	PBT/PC squirrel grey [similar RAL 7000]
	TPE anthracite [similar RAL 7016]
Front part	PBT/PC blue [similar RAL 5007]
Hinged lid	PC blue [similar RAL 5007]
Clamp basket	PBT/PC black [similar RAL 9005]
	TPE natural colour [no RAL colour code]
Fastening	PBT/PC squirrel grey [similar RAL 7000]
	TPE anthracite [similar RAL 7016]

Material resistance

The material resistance overview can be found on the website in the section “Knowledge” - “Product knowledge” - “Materials”.

Material and environmental properties

RoHS 2011/65/EU incl. 2015/863/EU	✓
POP regulation (EU) 2019/1021	✓

Regulations and Standards

Norm	DIN EN IEC 60309-2
Declaration of Conformity	CE
Test label	CB Zertifikat, VDE, EAC

Dimensional Drawing

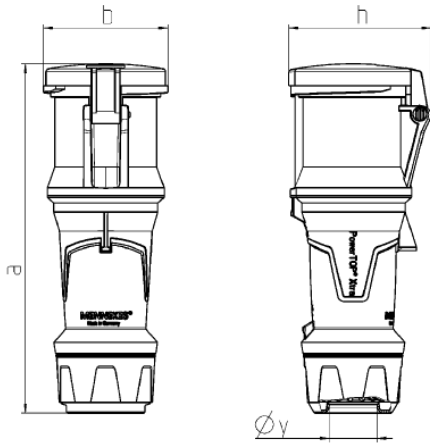

Drawing 3 MB 69	Amp. Poles	63		
		3	4	5
Dim. in mm	a	268	268	268
	b	95	95	95
	h	109	109	109
	y	36	36	36
Terminal for cond. cross		6	6	6
section (mm ²) min.-max.		—16	—16	—16