

Data Sheet | Item Number: 260-210

4-conductor terminal strip; without push-buttons; with fixing flanges; 10-pole; for screw or similar mounting types; Fixing hole 3.2 mm Ø; 1.5 mm²; CAGE CLAMP®; gray

<https://www.wago.com/260-210>

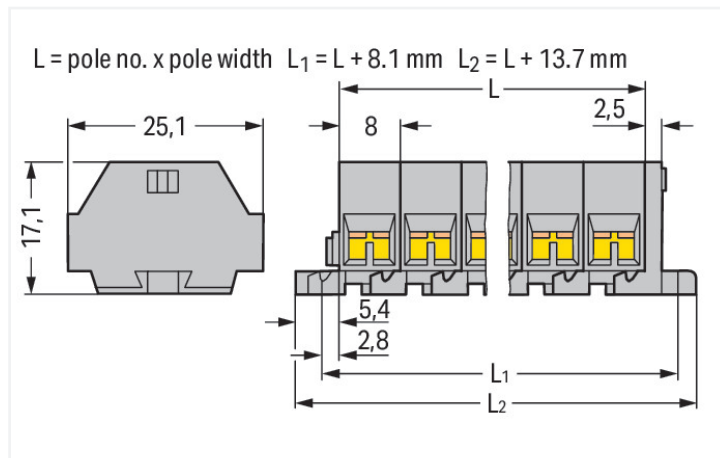
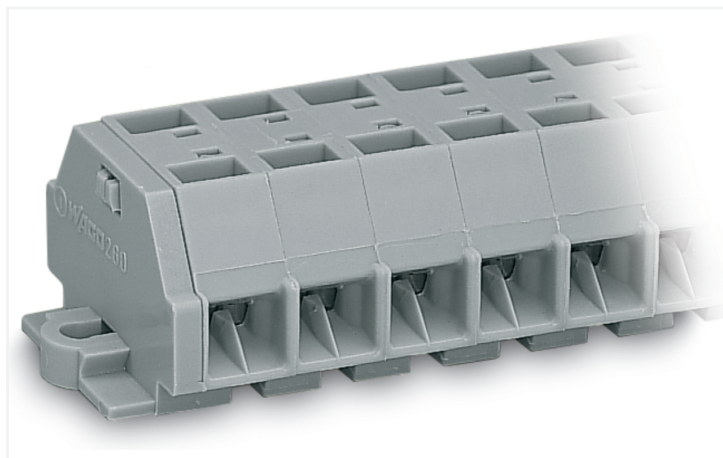

Color: ■ gray

Similar to illustration

Dimensions in mm

Through terminal block, 260 Series, CAGE CLAMP®

This through terminal block (item number 260-210) is designed for easy and secure connections. Conductors can only be connected to this through terminal block if their strip length is between 8 and 9 mm. Whether for industrial or building applications, you can use our through terminal blocks to connect electrical conductors quickly and safely. We offer variants for both classic through-wiring and potential distribution. This product incorporates conductor terminals and utilizes CAGE CLAMP®. Our CAGE CLAMP® connection offers a dependable and maintenance-free way to connect all types of conductors. You do not need to prepare the conductor in any way, such as crimping ferrules. The dimensions are (93.7 x 25.1 x 17.1) mm (width x height x depth). Depending on the conductor type, this through terminal block is ideal for conductor cross sections ranging from 0.08 mm² to 1.5 mm².

This mini rail-mount terminal block is operated with an operating tool.

Electrical data

Ratings per IEC/EN

Nominal voltage (III/3)	400 V
Rated impulse withstand voltage (III / 3)	6 kV
Rated current	18 A
Legend (ratings)	(III / 3) ≙ Overvoltage category III / Pollution degree 3

Approvals per

UL 1059

Use group	B	C	D
Rated voltage	300 V	300 V	600 V
Rated current	10 A	10 A	5 A

Approvals per

CSA 22.2 No 158

Use group	B	C	D
Rated voltage	-	300 V	-
Rated current	-	10 A	-

General information

Wiring direction	Side-entry wiring
------------------	-------------------

Connection Data

Clamping units	40
Total number of potentials	10
Number of levels	1

Connection 1

Connection technology	CAGE CLAMP®
Actuation type	Operating tool
Connectable conductor materials	Copper
Solid conductor	0.08 ... 1.5 mm ² / 28 ... 16 AWG
Fine-stranded conductor	0.08 ... 1.5 mm ² / 28 ... 16 AWG
Strip length	8 ... 9 mm / 0.31 ... 0.35 inches
Pole number	10
Wiring direction	Side-entry wiring

Physical data

Width	93.7 mm / 3.689 inches
Height	25.1 mm / 0.988 inches
Depth	17.1 mm / 0.673 inches
Module width	8 mm / 0.315 inches

Mechanical data

Design	horizontal type
Mounting type	Mounting flange
Marking level	Side marking

Material data

Note (material data)	Information on material specifications can be found here
Color	gray
Material group	I
Insulation material (main housing)	Polyamide (PA66)
Flammability class per UL94	V0
Fire load	0.447 MJ
Weight	25 g

Commercial data

PU (SPU)	25 pcs
Packaging type	Box
Country of origin	DE
GTIN	4044918594233
Customs tariff number	85369010000

Product Classification

UNSPSC	39121410
eCl@ss 10.0	27-14-11-06
eCl@ss 9.0	27-14-11-06
ETIM 9.0	EC001284
ETIM 10.0	EC001284
ECCN	NO US CLASSIFICATION

Environmental Product Compliance

RoHS Compliance Status	Compliant, No Exemption
------------------------	-------------------------

Approvals / Certificates

General approvals **Declarations of conformity and manufacturer's declarations**



Approval	Standard	Certificate Name
CCA DEKRA Certification B.V.	EN 60998	NTR-NL 6508
CCA DEKRA Certification B.V.	EN 60998	2110272.01
CSA DEKRA Certification B.V.	C22.2	70010891
UL Underwriters Laboratories Inc.	UL 1059	E45172

Approval	Standard	Certificate Name
EU-Declaration of Conformity WAGO GmbH & Co. KG	-	-
UK-Declaration of Conformity WAGO GmbH & Co. KG	-	-

Approvals for marine applications



Approval	Standard	Certificate Name
ABS American Bureau of Shipping	-	24-0095979-PDA
LR Lloyds Register	IEC 60998	LR22173030TA
PRS Polski Rejestr Statków	-	TE/1094/880590/23

Downloads





Environmental Product Compliance

Compliance Search	
Environmental Product Compliance 260-210	↓

Documentation

Bid Text			
260-210	19.02.2019	xml 3.11 KB	↓
260-210	14.06.2017	doc 24.50 KB	↓

CAD/CAE-Data











CAD data	CAE data
2D/3D Models 260-210 	EPLAN Data Portal 260-210 
	WSCAD Universe 260-210 
	ZUKEN Portal 260-210 

1 Compatible Products

1.1 Optional Accessories



1.1.1 Ferrule

1.1.1.1 Ferrule

 Item No.: 216-301 Ferrule; Sleeve for 0.25 mm ² / AWG 24; insulated; electro-tin plated; yellow	 Item No.: 216-302 Ferrule; Sleeve for 0.34 mm ² / 22 AWG; insulated; electro-tin plated; light turquoise	 Item No.: 216-201 Ferrule; Sleeve for 0.5 mm ² / 20 AWG; insulated; electro-tin plated; electrolytic copper; acc. to DIN 46228, Part 4/09.90; white	 Item No.: 216-101 Ferrule; Sleeve for 0.5 mm ² / AWG 22; un-insulated; electro-tin plated; silver-colored
 Item No.: 216-202 Ferrule; Sleeve for 0.75 mm ² / 18 AWG; insulated; electro-tin plated; gray	 Item No.: 216-102 Ferrule; Sleeve for 0.75 mm ² / AWG 20; un-insulated; electro-tin plated; silver-colored	 Item No.: 216-203 Ferrule; Sleeve for 1 mm ² / AWG 18; insulated; electro-tin plated; red	 Item No.: 216-103 Ferrule; Sleeve for 1 mm ² / AWG 18; un-insulated; electro-tin plated
 Item No.: 216-204 Ferrule; Sleeve for 1.5 mm ² / AWG 16; insulated; electro-tin plated; black	 Item No.: 216-104 Ferrule; Sleeve for 1.5 mm ² / AWG 16; un-insulated; electro-tin plated; silver-colored		

1.1.2 Installation

1.1.2.1 Mounting accessories

 Item No.: 209-137 Mounting adapter; can be used as end stop; 6.5 mm wide; gray	 Item No.: 209-123 Mounting foot with screw; can be screwed on terminal blocks with fixing flange; 6.4 mm wide; gray
---	--

1.1.3 Jumper

1.1.3.1 Jumper



Item No.: 260-402

Jumper; for conductor entry; 2-way; insulated; gray

1.1.4 Marking

1.1.4.1 Marking strip



Item No.: 210-833

Marking strips; 25 m on roll; 6 mm wide; plain; Self-adhesive; white

1.1.5 Test and measurement

1.1.5.1 Testing accessories



Item No.: 260-405

Test plug module; with locking latches; modular; for 4-conductor terminal blocks; for 260 Series; gray



Item No.: 249-138

Test plug module; without locking device; modular; for 4-conductor terminal blocks; gray

1.1.6 Tool

1.1.6.1 Operating tool



Item No.: 210-658

Operating tool; Blade: 3.5 x 0.5 mm; with a partially insulated shaft; angled; short; multicoloured



Item No.: 210-720

Operating tool; Blade: 3.5 x 0.5 mm; with a partially insulated shaft; multicoloured



Item No.: 210-657

Operating tool; Blade: 3.5 x 0.5 mm; with a partially insulated shaft; short; multicoloured

Installation Notes

Conductor termination

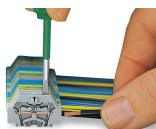

CAGE CLAMP® connection

Inserting a conductor.

With ferruled conductors, it is necessary to use a terminal block one size larger than the conductor's nominal cross-section.

Commoning



Commoning with comb-style jumper bar.

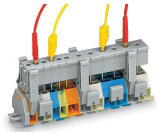

Testing via test plug modules snapped onto a terminal strip – wired or unwired. As touch contact is made with the CAGE CLAMP® (spring steel) unit, this testing type is limited to maximum 0.5 A.

Distance between locking devices must be approximately 35 ... 40 mm!

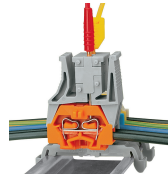

Testing after the conductors have been terminated.

Installation

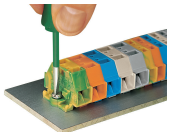

Mounting and securing a terminal strip directly to the plate via screw-type flanges.

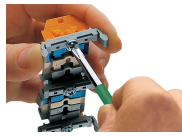

Terminal strip with mounting flanges
Screwing a mounting foot (209-123).
(Distance between mounting feet: approx. 25 ... 30 mm)

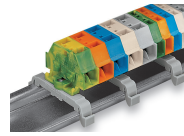

Terminal strip; with mounting flanges; for DIN-35 rail



Terminal strip with mounting flanges, for screw or similar mounting types, 3.2 mm mounting hole diameter (with 209-123 Mounting Foot also for DIN-35 rail)

Marking



Marking with self-adhesive marking strips.



Marking by direct printing (upon request).

Subject to changes. Please also observe the further product documentation!

Current addresses can be found at: www.wago.com