

## Data Sheet | Item Number: 262-212

4-conductor terminal strip; without push-buttons; with fixing flanges; 12-pole; for screw or similar mounting types; Fixing hole 3.2 mm Ø; 4 mm<sup>2</sup>; CAGE CLAMP®; 4,00 mm<sup>2</sup>; gray

<https://www.wago.com/262-212>

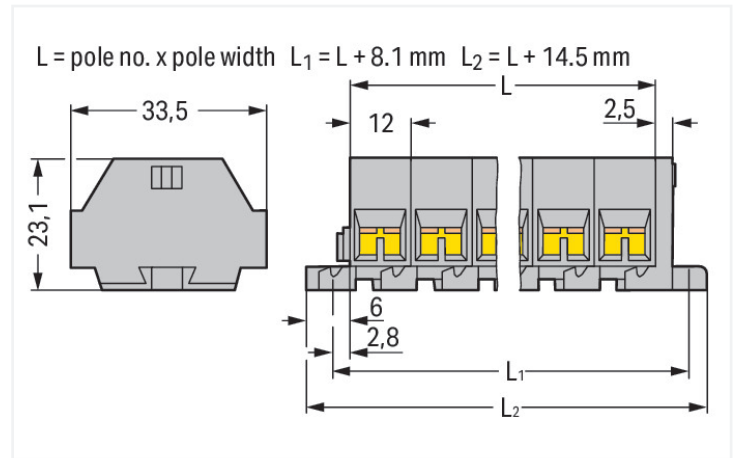
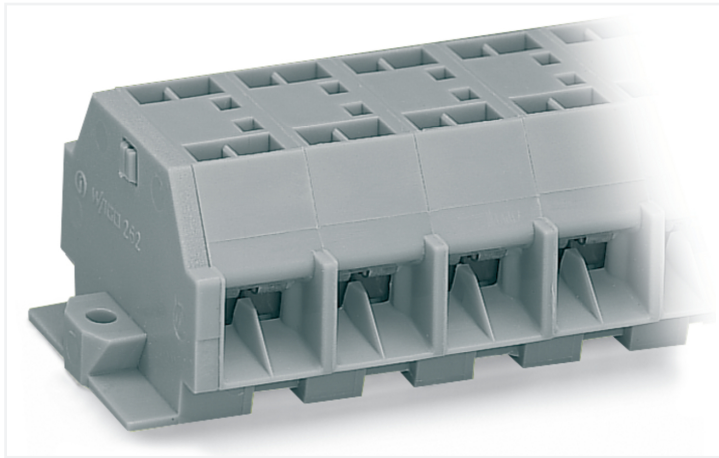

Color: ■ gray

Similar to illustration

Dimensions in mm

Through terminal block, 262 Series, gray

This through terminal block (item number 262-212) is designed for simple and secure connections. Ensure that the strip lengths are between 9 and 10 mm when connecting conductors to this through terminal block. Our mini rail-mount terminal blocks are the perfect choice for working in confined spaces. A large selection of mounting and actuation variants means you can find a suitable mini terminal block for every purpose. This also means you can adapt the terminal blocks to your unique requirements. This product features conductor terminals and utilizes CAGE CLAMP®. Our highly-rated and maintenance-free CAGE CLAMP® connection makes it easy to connect all types of conductors without having to prepare the conductor. For example, you don't need to crimp ferrules. The item's dimensions are (158.4 x 33.5 x 23.1) mm (width x height x depth). Depending on the type of conductor, this through terminal block is ideal for conductor cross sections ranging from 0.08 mm<sup>2</sup> to 4 mm<sup>2</sup>.

An operating tool is used to operate this mini rail-mount terminal block.

### Electrical data

Ratings per IEC/EN	
Nominal voltage (III/3)	690 V
Rated impulse withstand voltage (III / 3)	8 kV
Rated current	32 A
Legend (ratings)	(III / 3) ≙ Overvoltage category III / Pollution degree 3

Approvals per	UL 1059		
	B	C	D
Use group	B	C	D
Rated voltage	300 V	300 V	300 V
Rated current	20 A	20 A	10 A

Approvals per	CSA 22.2 No 158		
	B	C	D
Use group	B	C	D
Rated voltage	600 V	300 V	600 V
Rated current	5 A	25 A	5 A

General information	
Wiring direction	Side-entry wiring

### Connection Data

Clamping units	48
Total number of potentials	12
Number of levels	1

### Connection 1

Connection technology	CAGE CLAMP®
Actuation type	Operating tool
Connectable conductor materials	Copper
Solid conductor	0.08 ... 4 mm² / 28 ... 12 AWG
Fine-stranded conductor	0.08 ... 4 mm² / 28 ... 12 AWG
Strip length	9 ... 10 mm / 0.35 ... 0.39 inches
Pole number	12
Wiring direction	Side-entry wiring

### Physical data

Width	158.4 mm / 6.236 inches
Height	33.5 mm / 1.319 inches
Depth	23.1 mm / 0.909 inches
Module width	12 mm / 0.472 inches

### Mechanical data

Design	horizontal type
Mounting type	Mounting flange
Marking level	Side marking

### Material data

Note (material data)	<a href="#">Information on material specifications can be found here</a>
Color	gray
Material group	I
Insulation material (main housing)	Polyamide (PA66)
Flammability class per UL94	V0
Fire load	1.388 MJ
Halogen-free	Yes
Weight	84.3 g

### Commercial data

PU (SPU)	25 pcs
Packaging type	Box
Country of origin	DE
GTIN	4044918639408
Customs tariff number	85369010000

### Product Classification

UNSPSC	39121410
eCl@ss 10.0	27-14-11-06
eCl@ss 9.0	27-14-11-06
ETIM 9.0	EC001284
ETIM 10.0	EC001284
ECCN	NO US CLASSIFICATION

**Environmental Product Compliance**

RoHS Compliance Status	Compliant, No Exemption
------------------------	-------------------------

**Approvals / Certificates**

**General approvals** **Declarations of conformity and manufacturer's declarations**



Approval	Standard	Certificate Name
CCA DEKRA Certification B.V.	EN 60998	NTR NL 7661
CSA DEKRA Certification B.V.	C22.2	70010891
KEMA/KEUR DEKRA Certification B.V.	EN 60998	71-102644
UR Underwriters Laboratories Inc.	UL 1059	E45172

Approval	Standard	Certificate Name
EU-Declaration of Conformity WAGO GmbH & Co. KG	-	-
UK-Declaration of Conformity WAGO GmbH & Co. KG	-	-

**Approvals for marine applications**



Approval	Standard	Certificate Name
ABS American Bureau of Shipping	-	24-0095979-PDA
BV Bureau Veritas S.A.	EN 60947	07436/G0 BV
DNV GL Det Norske Veritas, Germanischer Lloyd	-	TAE00001V2
LR Lloyds Register	IEC 60998	LR22173030TA
PRS Polski Rejestr Statków	-	TE/1094/880590/23

**Downloads**

**Environmental Product Compliance**

Compliance Search
Environmental Product Compliance 262-212

**Documentation**

Bid Text			
262-212	17.08.2017	doc 24.50 KB	
262-212	19.02.2019	xml 3.10 KB	

**CAD/CAE-Data**

CAD data
2D/3D Models 262-212

CAE data
EPLAN Data Portal 262-212
WSCAD Universe 262-212
ZUKEN Portal 262-212

**1 Compatible Products**

**1.1 Optional Accessories**

**1.1.1 Ferrule**

**1.1.1.1 Ferrule**

 <b>Item No.: 216-241</b> Ferrule; Sleeve for 0.5 mm <sup>2</sup> / 20 AWG; un-insulated; electro-tin plated; electrolytic copper; gastight crimped; acc. to DIN 46228, Part 4/09.90; white	 <b>Item No.: 216-141</b> Ferrule; Sleeve for 0.5 mm <sup>2</sup> / 20 AWG; un-insulated; electro-tin plated; electrolytic copper; gastight crimped; acc. to DIN 46228, Part 1/08.92	 <b>Item No.: 216-242</b> Ferrule; Sleeve for 0.75 mm <sup>2</sup> / 18 AWG; un-insulated; electro-tin plated; electrolytic copper; gastight crimped; acc. to DIN 46228, Part 4/09.90; gray	 <b>Item No.: 216-262</b> Ferrule; Sleeve for 0.75 mm <sup>2</sup> / 18 AWG; un-insulated; electro-tin plated; electrolytic copper; gastight crimped; acc. to DIN 46228, Part 4/09.90; gray
 <b>Item No.: 216-142</b> Ferrule; Sleeve for 0.75 mm <sup>2</sup> / 18 AWG; un-insulated; electro-tin plated; electrolytic copper; gastight crimped; acc. to DIN 46228, Part 1/08.92	 <b>Item No.: 216-243</b> Ferrule; Sleeve for 1 mm <sup>2</sup> / AWG 18; un-insulated; electro-tin plated; electrolytic copper; gastight crimped; acc. to DIN 46228, Part 4/09.90; red	 <b>Item No.: 216-263</b> Ferrule; Sleeve for 1 mm <sup>2</sup> / AWG 18; un-insulated; electro-tin plated; electrolytic copper; gastight crimped; acc. to DIN 46228, Part 4/09.90; red	 <b>Item No.: 216-143</b> Ferrule; Sleeve for 1 mm <sup>2</sup> / AWG 18; un-insulated; electro-tin plated; electrolytic copper; gastight crimped; acc. to DIN 46228, Part 1/08.92
 <b>Item No.: 216-244</b> Ferrule; Sleeve for 1.5 mm <sup>2</sup> / AWG 16; un-insulated; electro-tin plated; electrolytic copper; gastight crimped; acc. to DIN 46228, Part 4/09.90; black	 <b>Item No.: 216-264</b> Ferrule; Sleeve for 1.5 mm <sup>2</sup> / AWG 16; un-insulated; electro-tin plated; electrolytic copper; gastight crimped; acc. to DIN 46228, Part 4/09.90; black	 <b>Item No.: 216-284</b> Ferrule; Sleeve for 1.5 mm <sup>2</sup> / AWG 16; un-insulated; electro-tin plated; electrolytic copper; gastight crimped; acc. to DIN 46228, Part 4/09.90; black	 <b>Item No.: 216-144</b> Ferrule; Sleeve for 1.5 mm <sup>2</sup> / AWG 16; un-insulated; electro-tin plated; electrolytic copper; gastight crimped; acc. to DIN 46228, Part 1/08.92; silver-colored
 <b>Item No.: 216-289</b> Ferrule; Sleeve for 10 mm <sup>2</sup> / AWG 8; un-insulated; electro-tin plated; electrolytic copper; gastight crimped; acc. to DIN 46228, Part 4/09.90; red	 <b>Item No.: 216-209</b> Ferrule; Sleeve for 10 mm <sup>2</sup> / AWG 8; un-insulated; electro-tin plated; red	 <b>Item No.: 216-109</b> Ferrule; Sleeve for 10 mm <sup>2</sup> / AWG 8; un-insulated; electro-tin plated	 <b>Item No.: 216-210</b> Ferrule; Sleeve for 16 mm <sup>2</sup> / AWG 6; un-insulated; electro-tin plated; electrolytic copper; gastight crimped; acc. to DIN 46228, Part 4/09.90; blue
 <b>Item No.: 216-110</b> Ferrule; Sleeve for 16 mm <sup>2</sup> / AWG 6; un-insulated; electro-tin plated; brown metallic	 <b>Item No.: 216-246</b> Ferrule; Sleeve for 2.5 mm <sup>2</sup> / AWG 14; un-insulated; electro-tin plated; electrolytic copper; gastight crimped; acc. to DIN 46228, Part 4/09.90; blue	 <b>Item No.: 216-266</b> Ferrule; Sleeve for 2.5 mm <sup>2</sup> / AWG 14; un-insulated; electro-tin plated; electrolytic copper; gastight crimped; acc. to DIN 46228, Part 4/09.90; blue	 <b>Item No.: 216-286</b> Ferrule; Sleeve for 2.5 mm <sup>2</sup> / AWG 14; un-insulated; electro-tin plated; electrolytic copper; gastight crimped; acc. to DIN 46228, Part 4/09.90; blue

### 1.1.1.1 Ferrule



**Item No.: 216-267**

Ferrule; Sleeve for 4 mm<sup>2</sup> / AWG 12; insulated; electro-tin plated; electrolytic copper; gastight crimped; acc. to DIN 46228, Part 4/09.90; gray



**Item No.: 216-287**

Ferrule; Sleeve for 4 mm<sup>2</sup> / AWG 12; insulated; electro-tin plated; electrolytic copper; gastight crimped; acc. to DIN 46228, Part 4/09.90; gray



**Item No.: 216-208**

Ferrule; Sleeve for 6 mm<sup>2</sup> / AWG 10; insulated; electro-tin plated; electrolytic copper; gastight crimped; acc. to DIN 46228, Part 4/09.90; yellow



**Item No.: 216-288**

Ferrule; Sleeve for 6 mm<sup>2</sup> / AWG 10; insulated; electro-tin plated; electrolytic copper; gastight crimped; acc. to DIN 46228, Part 4/09.90; yellow



**Item No.: 216-108**

Ferrule; Sleeve for 6 mm<sup>2</sup> / AWG 10; un-insulated; electro-tin plated; silver-colored

### 1.1.2 Installation

#### 1.1.2.1 Mounting accessories



**Item No.: 209-137**

Mounting adapter; can be used as end stop; 6.5 mm wide; gray



**Item No.: 209-123**

Mounting foot with screw; can be screwed on terminal blocks with fixing flange; 6.4 mm wide; gray

### 1.1.3 Jumper

#### 1.1.3.1 Jumper



**Item No.: 262-402**

Jumper; for conductor entry; 2-way; insulated; gray

### 1.1.4 Marking

#### 1.1.4.1 Marking strip



**Item No.: 210-833**

Marking strips; 25 m on roll; 6 mm wide; plain; Self-adhesive; white

### 1.1.5 Test and measurement

#### 1.1.5.1 Testing accessories



**Item No.: 249-140**

Test plug module; without locking device; modular; for 4-conductor terminal blocks; gray

## 1.1.6 Tool

### 1.1.6.1 Operating tool



**Item No.: 210-658**

Operating tool; Blade: 3.5 x 0.5 mm; with a partially insulated shaft; angled; short; multicoloured



**Item No.: 210-720**

Operating tool; Blade: 3.5 x 0.5 mm; with a partially insulated shaft; multicoloured



**Item No.: 210-657**

Operating tool; Blade: 3.5 x 0.5 mm; with a partially insulated shaft; short; multicoloured

## Installation Notes

### Conductor termination

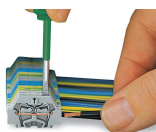

**CAGE CLAMP® connection**

Inserting a conductor.

With ferruled conductors, it is necessary to use a terminal block one size larger than the conductor's nominal cross-section.

### Commoning

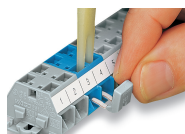

Commoning with comb-style jumper bar.

## Installation

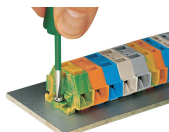

Mounting and securing a terminal strip directly to the plate via screw-type flanges.

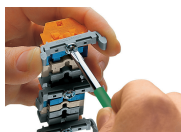

Terminal strip with mounting flanges  
Screwing a mounting foot (209-123).  
(Distance between mounting feet: approx. 25 ... 30 mm)

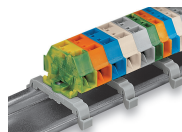

Terminal strip; with mounting flanges; for DIN-35 rail



Terminal strip with mounting flanges, for screw or similar mounting types, 3.2 mm mounting hole diameter (with 209-123 Mounting Foot also for DIN-35 rail)

Marking



Marking with self-adhesive marking strips.

Marking by direct printing (upon request).