

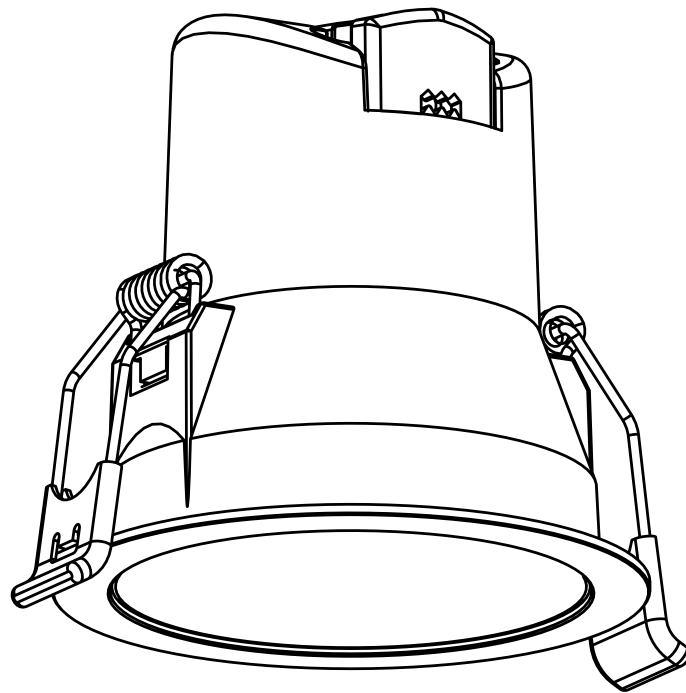

Read these instructions & save for future use

Spot | black | cut out Ø90-95mm | 9W | 3000K | dim



Article number **136-107**

Brand **Tronix Lighting**

Type **Downlights | Reflector**

Contents of this product **1x Downlight 9 Watt
with external driver**

Technical datasheet **Digitally available
on our webshop**



*View instructions and
technical data also on
our website*

TRONIX



Before first use

Before getting started with this product, it is advisable to check the order completeness and any damage. If this is the case, please contact Tronix Lighting.

Description

Thanks to this strong, high-quality LED spotlight, there is always more than enough light available. Using a compact, elegant and fashionable design, the light is not only softened, but the light source also remains protected from heat and noxious substances.

In short, a beautiful spotlight perfect for use in the office, living spaces, schools, hotels and other public locations.

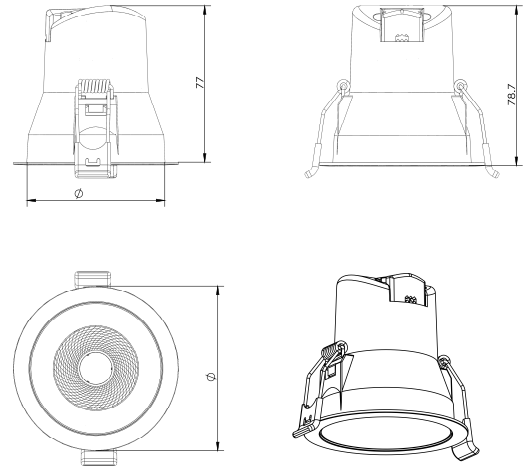

Installation

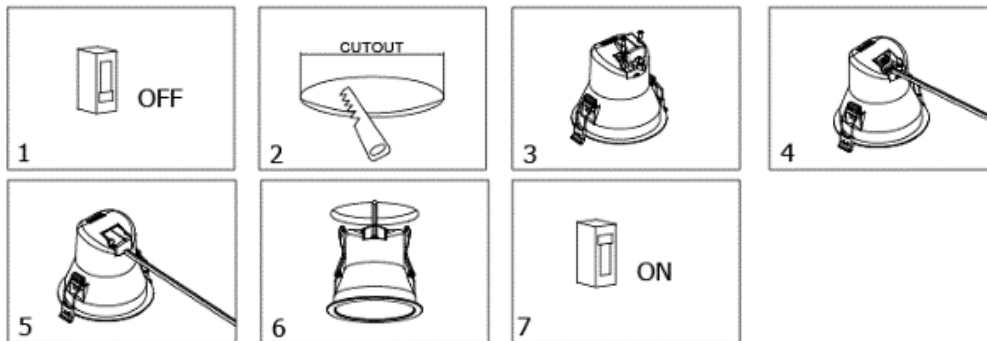

1. Remove the product from the packaging and turn off the power;
2. Drill a suitable mounting hole in the ceiling based on the hole size of the product;
3. Open the wiring cover using a Phillips screwdriver;
4. Fit the wiring to the fixture and connect it to mains power;
5. Close the cover and check the wiring again;
6. Push the clamps against the fixture and push the spotlight through the hole. The spotlight then clamps itself in place;
7. Check the wiring and placement of the spotlight again. Make sure the light is at an appropriate distance from view to avoid looking directly into the light for long periods of time. Turn on the power.



Safety

Safety is a top priority at Tronix Lighting. Therefore, we heartily recommend that you follow the following steps closely:

- Keep this manual carefully for future reference;
- Choose a qualified electrician while installing, maintaining or inspecting this product;
- Never look directly into a light source to avoid possible eye damage;
- Ensure that the respective power group is always on non-active when the product is connected;
- Use only recommended combinations (LED drivers, controllers or dimmers) to avoid injury or damage to the product;
- The light source of this spotlight is not replaceable. Because of this, you must replace the entire fixture towards the end of its lifespan and it is not recommended to open it;
- Place this spotlight indoors only at a standard room temperature (~25°C).

Technical problems and repair

Should a product not work properly after installation, or if the product exhibits problems over time, it is advisable to check the following elements:

- Check the wiring and installation of your product;
- Check for the presence of interfering elements such as dust, water or other electronics;
- If possible, try disconnecting the product and testing it in another location to rule out a problem at the location;
- Should you be dealing with a WIFI-based product, check and reset your router's settings.

Should the product still not work after testing, it is recommended to send it in for inspection and/or repair. To do so, please contact Tronix Lighting using nearby details and proof of purchase (packing slip).



CARE



SHARE



CONNECT

Supplier:

Tronix Lighting B.V

Vluchtoord 41
5406 XP Uden, Netherlands

+31 (0)413 330 380
sales@tronixlighting.com

Terms and symbols (as relevant to product)



The **CE mark** indicates that this product complies with EU regulations on safety, health and environmental protection;



The **WEEE symbol** stands for "Waste Electrical and Electronic Equipment Regulation," a directive on the collection, recycling and recovery of electronic waste;



The **Class II symbol** indicates that this product is double insulated;

- The product is rated **IP20**. This means that the product is resistant to the penetration of solid objects >12.5 mm and is not resistant to water or moisture.