

Data Sheet | Item Number: 2092-3603

Gripping plate; for female and male connectors; 1 part; Pin spacing 7.5 mm; light gray

<https://www.wago.com/2092-3603>

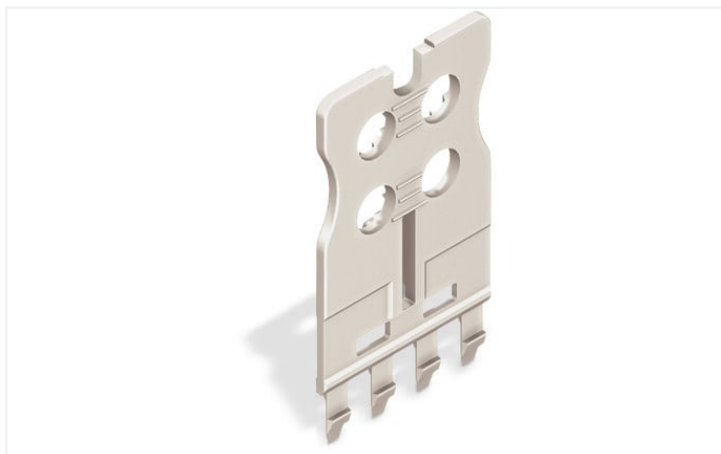

Color: ■ light gray

Similar to illustration

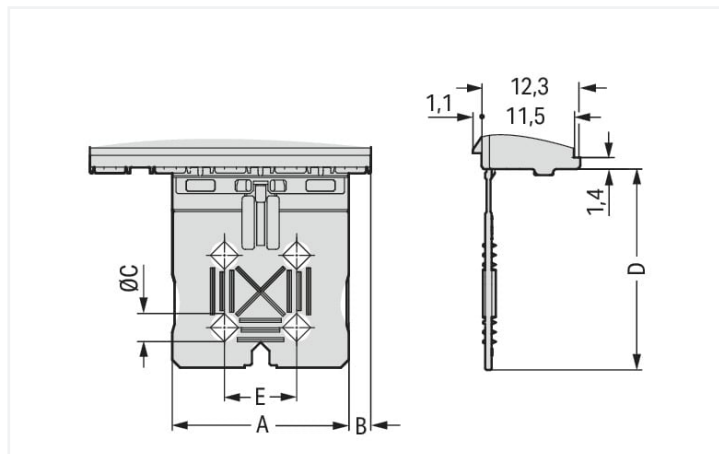

Dimensions in mm

Physical data

Pin spacing 7.5 mm / 0.295 inches

Material data

Note (material data)

[Information on material specifications can be found here](https://www.wago.com/us/material-specifications)

Color light gray

Fire load 0.04 MJ

Weight 1.3 g

Commercial data

Product Group 26 (picoMAX Connectors)

eCl@ss 10.0 27-14-11-92

eCl@ss 9.0 27-14-11-92

ETIM 8.0 EC002848

ETIM 7.0 EC002848

PU (SPU) 100 (25) pcs

Packaging type Box

Country of origin DE

GTIN 4050821164937

Customs tariff number 85389099990

Environmental Product Compliance

RoHS Compliance Status Compliant, No Exemption

Downloads

Environmental Product Compliance

Compliance Search

Environmental Product
Compliance 2092-3603



Documentation

Additional Information

Technical Section

03.04.2019

pdf

2010.85 KB



Installation Notes

Strain relief

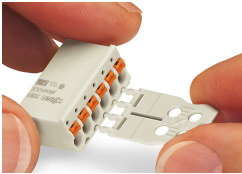

Gripping plates are suitable for factory and field assembly.