

## Data Sheet | Item Number: 264-258

4-conductor terminal strip; without push-buttons; with snap-in mounting feet; 8-pole; for plate thickness 0.6 - 1.2 mm; Fixing hole 3.5 mm Ø; 2.5 mm<sup>2</sup>; CAGE CLAMP®; gray

<https://www.wago.com/264-258>

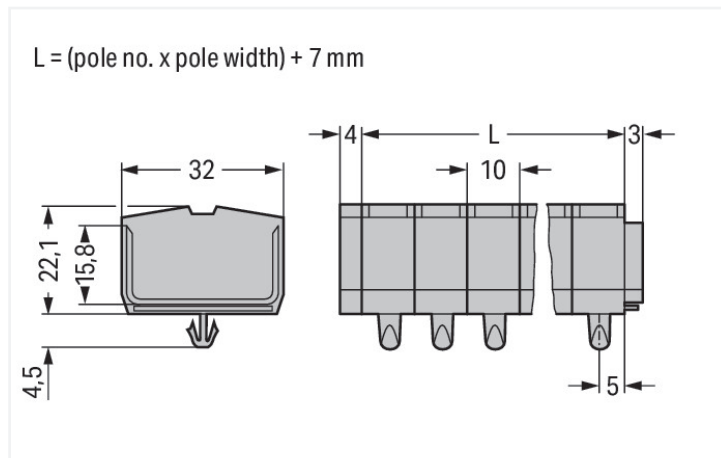
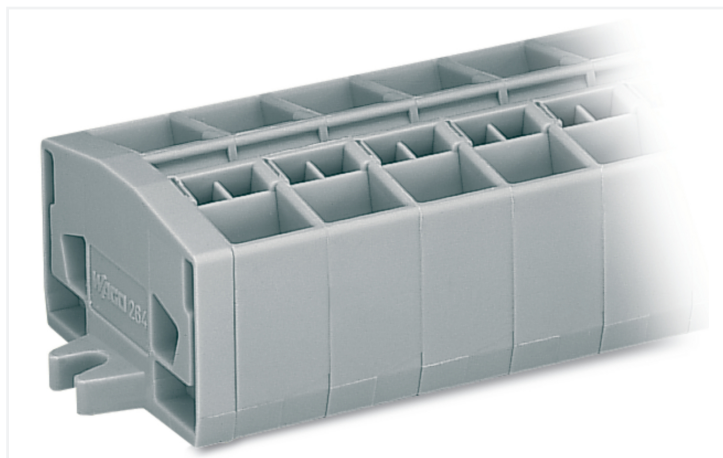

Color: ■ gray

Similar to illustration

Dimensions in mm

Through terminal block, 264 Series, operating tool

Quick and easy connections are guaranteed with this through terminal block (item number 264-258). Strip lengths must be between 8 and 9 mm when connecting conductors to this through terminal block. Our mini rail-mount terminal blocks are perfect for working in small spaces thanks to their compact design. With various mounting and actuation options, they offer complete flexibility. This product incorporates conductor terminals and utilizes CAGE CLAMP®. Our celebrated universal connection known as CAGE CLAMP® is the industry standard for connection technology and electrical interconnections. The item's dimensions are (87 x 32 x 26.6) mm (width x height x depth). This through terminal block is suitable for conductor cross sections ranging from 0.08 mm<sup>2</sup> to 2.5 mm<sup>2</sup>.

This mini rail-mount terminal block is operated with an operating tool.

### Electrical data

#### Ratings per IEC/EN

Nominal voltage (III/3)	800 V
Rated impulse withstand voltage (III / 3)	8 kV
Rated current	24 A
Legend (ratings)	(III / 3) ≙ Overvoltage category III / Pollution degree 3

#### Approvals per

#### UL 1059

Use group	B	C	D
Rated voltage	600 V	600 V	-
Rated current	20 A	20 A	-

#### Approvals per

#### CSA 22.2 No 158

Use group	B	C	D
Rated voltage	-	600 V	-
Rated current	-	20 A	-

#### General information

Wiring direction	Front-entry wiring
------------------	--------------------

## Connection Data

Clamping units	32
Total number of potentials	8
Number of levels	1

## Connection 1

Connection technology	CAGE CLAMP®
Actuation type	Operating tool
Connectable conductor materials	Copper
Solid conductor	0.08 ... 2.5 mm <sup>2</sup> / 28 ... 12 AWG
Fine-stranded conductor	0.08 ... 2.5 mm <sup>2</sup> / 28 ... 12 AWG
Note (conductor cross-section)	12 AWG: THHN, THWN
Strip length	8 ... 9 mm / 0.31 ... 0.35 inches
Pole number	8
Wiring direction	Front-entry wiring

## Physical data

Width	87 mm / 3.425 inches
Height	32 mm / 1.26 inches
Height from the surface	22.1 mm / 0.87 inches
Depth	26.6 mm / 1.047 inches
Module width	10 mm / 0.394 inches

## Mechanical data

Design	horizontal type
Mounting type	Snap-in foot
Marking level	Center marking

## Material data

Note (material data)	<a href="#">Information on material specifications can be found here</a>
Color	gray
Material group	I
Insulation material (main housing)	Polyamide (PA66)
Flammability class per UL94	V0
Fire load	0.976 MJ
Halogen-free	Yes
Weight	53 g

## Environmental requirements

Processing temperature	-35 ... +85 °C
Continuous operating temperature	-60 ... +105 °C

## Commercial data

PU (SPU)	50 pcs
Packaging type	Box
Country of origin	DE
GTIN	4044918416061
Customs tariff number	85369010000

### Product Classification

UNSPSC	39121410
eCl@ss 10.0	27-14-11-06
eCl@ss 9.0	27-14-11-06
ETIM 9.0	EC001284
ETIM 10.0	EC001284
ECCN	NO US CLASSIFICATION

### Environmental Product Compliance

RoHS Compliance Status	Compliant, No Exemption
------------------------	-------------------------

### Approvals / Certificates

#### General approvals



Approval	Standard	Certificate Name
CB DEKRA Certification B.V.	EN 60998	NL-49768
CCA DEKRA Certification B.V.	EN 60998	NTR NL-7342
CCA DEKRA Certification B.V.	EN 60998	2175624.01
CSA DEKRA Certification B.V.	C22.2	70010891
UR Underwriters Laboratories Inc.	UL 1059	E45172

#### Declarations of conformity and manufacturer's declarations

Approval	Standard	Certificate Name
EU-Declaration of Conformity WAGO GmbH & Co. KG	-	-
UK-Declaration of Conformity WAGO GmbH & Co. KG	-	-

### Approvals for marine applications



Approval	Standard	Certificate Name
ABS American Bureau of Shipping	-	24-0095979-PDA
DNV GL Det Norske Veritas, Germanischer Lloyd	-	TAE00001V2
LR Lloyds Register	IEC 60998	LR22173030TA
PRS Polski Rejestr Statków	-	TE/1094/880590/23

## Downloads

### Environmental Product Compliance

Compliance Search			
Environmental Product Compliance 264-258			↓

## Documentation

Bid Text			
264-258	19.02.2019	xml 3.21 KB	↓
264-258	14.06.2017	doc 25.00 KB	↓

## CAD/CAE-Data

CAD data	
2D/3D Models 264-258	↓

CAE data	
EPLAN Data Portal 264-258	↓
WSCAD Universe 264-258	↓
ZUKEN Portal 264-258	↓

## 1 Compatible Products

### 1.1 Optional Accessories

#### 1.1.1 DIN-rail

##### 1.1.1.1 Mounting accessories



**Item No.: 210-154**  
 Aluminum carrier rail; 1000 mm long; 18 mm wide; 7 mm high; silver-colored

#### 1.1.2 Ferrule

##### 1.1.2.1 Ferrule

<p><b>Item No.: 216-131</b>                      Ferrule; Sleeve for 0.25 mm<sup>2</sup> / AWG 24; uninsulated; electro-tin plated; silver-colored</p>	<p><b>Item No.: 216-201</b>                      Ferrule; Sleeve for 0.5 mm<sup>2</sup> / 20 AWG; insulated; electro-tin plated; electrolytic copper; acc. to DIN 46228, Part 4/09.90; white</p>	<p><b>Item No.: 216-101</b>                      Ferrule; Sleeve for 0.5 mm<sup>2</sup> / AWG 22; uninsulated; electro-tin plated; silver-colored</p>	<p><b>Item No.: 216-202</b>                      Ferrule; Sleeve for 0.75 mm<sup>2</sup> / 18 AWG; insulated; electro-tin plated; gray</p>
<p><b>Item No.: 216-102</b>                      Ferrule; Sleeve for 0.75 mm<sup>2</sup> / AWG 20; uninsulated; electro-tin plated; silver-colored</p>	<p><b>Item No.: 216-203</b>                      Ferrule; Sleeve for 1 mm<sup>2</sup> / AWG 18; insulated; electro-tin plated; red</p>	<p><b>Item No.: 216-103</b>                      Ferrule; Sleeve for 1 mm<sup>2</sup> / AWG 18; uninsulated; electro-tin plated</p>	<p><b>Item No.: 216-204</b>                      Ferrule; Sleeve for 1.5 mm<sup>2</sup> / AWG 16; insulated; electro-tin plated; black</p>

1.1.2.1 Ferrule



**Item No.: 216-104**  
 Ferrule; Sleeve for 1.5 mm<sup>2</sup> / AWG 16; un-insulated; electro-tin plated; silver-colored

**Item No.: 216-205**  
 Ferrule; Sleeve for 2.08 mm<sup>2</sup> / AWG 14; un-insulated; electro-tin plated; yellow

**Item No.: 216-206**  
 Ferrule; Sleeve for 2.5 mm<sup>2</sup> / AWG 14; un-insulated; electro-tin plated; blue

**Item No.: 216-106**  
 Ferrule; Sleeve for 2.5 mm<sup>2</sup> / AWG 14; un-insulated; electro-tin plated; silver-colored

1.1.3 Installation

1.1.3.1 Cover



**Item No.: 709-153**  
 Cover; Type 1; suitable for cover carrier, type 1; 1 m long; transparent

1.1.3.2 Cover carrier



**Item No.: 709-167**  
 Cover carrier; Type 1; incl. fixing/retaining screws and knurled nut; suitable for 279 to 282 and 880 Series rail-mounted terminal blocks; suitable for 264 Series miniature rail-mounted terminal blocks; suitable for 270 Series sensor and actuator terminal blocks; gray

1.1.4 Jumper

1.1.4.1 Jumper



**Item No.: 280-492**  
 Jumper; 2-way; insulated; gray

**Item No.: 264-402**  
 Jumper; for conductor entry; 2-way; insulated; gray

1.1.5 Marking

1.1.5.1 Marker



**Item No.: 2009-145/000-006**  
 Mini-WSB Inline; for Smart Printer; 1700 pieces on roll; stretchable 5 - 5.2 mm; plain; snap-on type; blue

**Item No.: 2009-145/000-007**  
 Mini-WSB Inline; for Smart Printer; 1700 pieces on roll; stretchable 5 - 5.2 mm; plain; snap-on type; gray

**Item No.: 2009-145/000-023**  
 Mini-WSB Inline; for Smart Printer; 1700 pieces on roll; stretchable 5 - 5.2 mm; plain; snap-on type; green

**Item No.: 2009-145/000-012**  
 Mini-WSB Inline; for Smart Printer; 1700 pieces on roll; stretchable 5 - 5.2 mm; plain; snap-on type; orange



**Item No.: 2009-145/000-005**  
 Mini-WSB Inline; for Smart Printer; 1700 pieces on roll; stretchable 5 - 5.2 mm; plain; snap-on type; red

**Item No.: 2009-145/000-024**  
 Mini-WSB Inline; for Smart Printer; 1700 pieces on roll; stretchable 5 - 5.2 mm; plain; snap-on type; violet

**Item No.: 2009-145**  
 Mini-WSB Inline; for Smart Printer; 1700 pieces on roll; stretchable 5 - 5.2 mm; plain; snap-on type; white

**Item No.: 2009-145/000-002**  
 Mini-WSB Inline; for Smart Printer; 1700 pieces on roll; stretchable 5 - 5.2 mm; plain; snap-on type; yellow



**Item No.: 248-501/000-006**  
 Mini-WSB marking card; as card; not stretchable; plain; snap-on type; blue

**Item No.: 248-501/000-007**  
 Mini-WSB marking card; as card; not stretchable; plain; snap-on type; gray

**Item No.: 248-501/000-023**  
 Mini-WSB marking card; as card; not stretchable; plain; snap-on type; green

**Item No.: 248-501/000-017**  
 Mini-WSB marking card; as card; not stretchable; plain; snap-on type; light green

1.1.5.1 Marker



**Item No.: 248-501/000-012**  
Mini-WSB marking card; as card; not stretchable; plain; snap-on type; orange



**Item No.: 248-501/000-005**  
Mini-WSB marking card; as card; not stretchable; plain; snap-on type; red



**Item No.: 248-501/000-024**  
Mini-WSB marking card; as card; not stretchable; plain; snap-on type; violet



**Item No.: 248-501**  
Mini-WSB marking card; as card; not stretchable; plain; snap-on type; white



**Item No.: 248-501/000-002**  
Mini-WSB marking card; as card; not stretchable; plain; snap-on type; yellow

1.1.6 Test and measurement

1.1.6.1 Testing accessories



**Item No.: 249-139**  
Test plug module; without locking device; modular; for 4-conductor terminal blocks; gray



**Item No.: 210-136**  
Test plug; 2 mm Ø; with 500 mm cable; red

1.1.7 Tool

1.1.7.1 Operating tool



**Item No.: 210-658**  
Operating tool; Blade: 3.5 x 0.5 mm; with a partially insulated shaft; angled; short; multicoloured



**Item No.: 210-720**  
Operating tool; Blade: 3.5 x 0.5 mm; with a partially insulated shaft; multicoloured



**Item No.: 210-657**  
Operating tool; Blade: 3.5 x 0.5 mm; with a partially insulated shaft; short; multicoloured



**Item No.: 209-130**  
Operating tool; made of insulating material; 1-way; for 264 Series (1-/2-way), 280, 281 Series (up to 3-way); natural



**Item No.: 280-432**  
Operating tool; made of insulating material; 2-way; white

Installation Notes

Installation

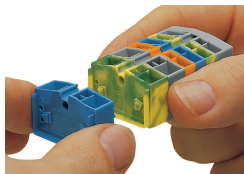

Assembling modular terminal blocks into terminal strips.

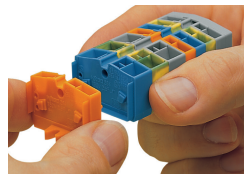

Mounting an "end terminal block" with mounting flange.

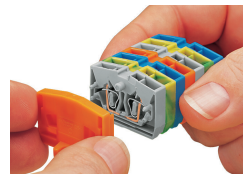

Mounting an end plate.

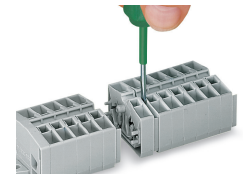

Removing a terminal block.

## Conductor termination



### CAGE CLAMP® connection

Inserting a conductor.

With ferruled conductors, it is necessary to use a terminal block one size smaller than the conductor's nominal cross-section.

## Commoning

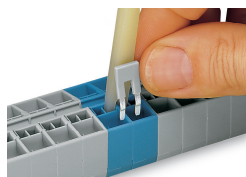

Commoning with comb-style jumper bar.

## Testing

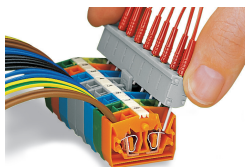

Testing by touch contact to the CAGE CLAMP® spring (limited to 0.5 A and 48 V test voltage) – test pins are not protected against accidental contact.

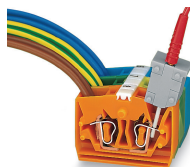

Testing via CAGE CLAMP® on the current bar (max. nominal current: 6 A). CAGE CLAMP® clamps individual test contacts. The maximum test voltage is 400 V.

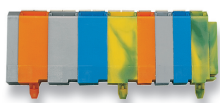

Terminal strip with mounting flanges, consisting of:

- End plate
- 4-conductor terminal block with snap-in mounting foot<sup>1)</sup>
- Center terminal blocks
- 2-conductor terminal block with snap-in mounting foot<sup>1)</sup> at every 4th or 5th terminal block of the strip

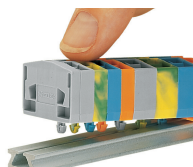
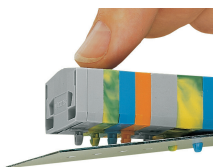

Mounting a terminal strip with snap-in feet into holes.

Mounting a terminal strip with snap-in feet onto aluminum rail.

## Marking



Marking via Mini-WSB Quick Marking System.