

Data Sheet | Item Number: 734-104

1-conductor female connector; CAGE CLAMP®; 1.5 mm²; Pin spacing 3.5 mm; 4-po-
le; 100% protected against mismatching; light gray

<https://www.wago.com/734-104>



Color: ■ light gray

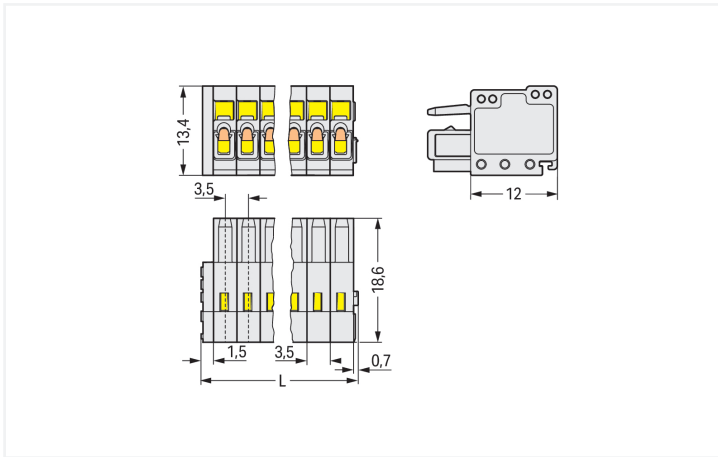

Dimensions in mm

$L = (\text{pole no.} \times \text{pin spacing}) + 2.2 \text{ mm}$

Female connector, 734 Series, operating tool

Our female connector (item number 734-104) ensures effortless electrical installations. Conductors should only be connected to this female connector if their strip length is between 6 and 7 mm. This product incorporates one conductor terminal and utilizes CAGE CLAMP®. Our tried-and-tested universal connection known as CAGE CLAMP® is industry-leading when it comes to connection technology and electrical interconnections. The item's dimensions are (16.2 x 13.4 x 18.6) mm (width x height x depth). This female connector is suitable for conductor cross sections ranging from 0.08 mm² to 1.5 mm².

The contact surface is coated with tin.

Notes

Safety Information

The MCS – MULTI CONNECTION SYSTEM includes connectors without breaking capacity in accordance with DIN EN 61984. When used as intended, these connectors must not be connected/disconnected when live or under load. When used as intended, these connectors must not be connected/disconnected when live or under load. The circuit design should ensure header pins, which can be touched, are not live when unmated.

Variants:

Other pole numbers

Gold-plated or partially gold-plated contact surfaces

Other versions (or variants) can be requested from WAGO Sales or configured at <https://configurator.wago.com/>.

Electrical data

Ratings per	IEC/EN 60664-1		
Overvoltage category	III	III	II
Pollution degree	3	2	2
Nominal voltage	160 V	160 V	320 V
Rated impulse withstand voltage	2.5 kV	2.5 kV	2.5 kV
Rated current	10 A	10 A	10 A

Approvals per	UL 1059		
Use group	B	C	D
Rated voltage	300 V	-	300 V
Rated current	10 A	-	10 A

Approvals per	CSA		
Use group	B	C	D
Rated voltage	300 V	-	300 V
Rated current	10 A	-	10 A

Connection Data

Clamping units	4
Total number of potentials	4
Number of connection types	1
Number of levels	1

Connection 1

Connection technology	CAGE CLAMP®
Actuation type	Operating tool
Actuation direction 1	Operation parallel to conductor entry
Actuation direction 2	Operation perpendicular to conductor entry
Solid conductor	0.08 ... 1.5 mm ² / 28 ... 14 AWG
Fine-stranded conductor	0.08 ... 1.5 mm ² / 28 ... 14 AWG
Fine-stranded conductor; with insulated ferrule	0.25 ... 1.5 mm ²
Fine-stranded conductor; with uninsulated ferrule	0.25 ... 1.5 mm ²
Note (conductor cross-section)	Terminating 1.5 mm ² conductors is possible; however insulation diameter does not allow clamping units to be terminated in a row.
Strip length	6 ... 7 mm / 0.24 ... 0.28 inches
Pole number	4
Conductor entry direction to mating direction	0°

Physical data

Pin spacing	3.5 mm / 0.138 inches
Width	16.2 mm / 0.638 inches
Height	13.4 mm / 0.528 inches
Depth	18.6 mm / 0.732 inches

Mechanical data

Variable coding	Yes
Anti-rotation protection	Yes

Plug-in connection

Contact type (pluggable connector)	Female connector/socket
Connector (connection type)	for conductor
Mismating protection	Yes

Material data

Note (material data)	Information on material specifications can be found here
Color	light gray
Material group	I
Insulation material (main housing)	Polyamide (PA66)
Flammability class per UL94	V0
Clamping spring material	Chrome-nickel spring steel (CrNi)
Contact material	Copper alloy
Contact Plating	Tin
Fire load	0.051 MJ
Weight	3.2 g

Environmental requirements

Limit temperature range	-60 ... +100 °C
Processing temperature	-35 ... +60 °C

Environmental Testing

Test specification: Railway applications – Rolling stock – Electronic equipment	DIN EN 50155 (VDE 0115-200):2022-06
Test procedure: Railway applications – Rolling stock equipment – Vibration and shock tests	DIN EN 61373 (VDE 0115-0106):2011-04
Spectrum/Mounting location	Service life test, Category 1, Class A/B
Functional test with noise-like oscillations	Test passed according to Section 8 of the standard
Frequency	$f_1 = 5 \text{ Hz}$ to $f_2 = 150 \text{ Hz}$
Acceleration	0.101g (highest test level used for all axes)
Test duration per axis	10 min.
Test directions	X, Y and Z axes
Monitoring of contact faults and interruptions	Passed
Voltage drop measurement before and after each axis	Passed
Simulated service life test through increased levels of noise-like oscillations	Test passed according to Section 9 of the standard
Frequency	$f_1 = 5 \text{ Hz}$ to $f_2 = 150 \text{ Hz}$
Acceleration	0.572g (highest test level used for all axes)
Test duration per axis	5 h
Test directions	X, Y and Z axes

Environmental Testing

Extended testing: Monitoring of contact faults and interruptions	Passed
Extended testing: Voltage drop measurement before and after each axis	Passed
Shock test	Test passed according to Section 10 of the standard
Shock pulse form	Half sine
Acceleration	5g (highest test level used for all axes)
Shock duration	30 ms
Number of shocks (per axis)	3 pos. und 3 neg.
Test directions	X, Y and Z axes
Extended testing: Monitoring of contact faults and interruptions	Passed
Extended testing: Voltage drop measurement before and after each axis	Passed
Vibration and shock stress for rolling stock equipment	Passed

Commercial data

Product Group	3 (Multi Conn. System)
PU (SPU)	100 pcs
Packaging type	Box
Country of origin	DE
GTIN	4044918492478
Customs tariff number	85366990990

Product Classification

UNSPSC	39121409
eCl@ss 10.0	27-44-03-09
eCl@ss 9.0	27-44-03-09
ETIM 9.0	EC002638
ETIM 10.0	EC002638
ECCN	NO US CLASSIFICATION

Environmental Product Compliance

RoHS Compliance Status	Compliant, No Exemption
------------------------	-------------------------

Approvals / Certificates

General approvals



Approval	Standard	Certificate Name
CCA DEKRA Certification B.V.	EN 61984	2169534.02
CCA DEKRA Certification B.V.	EN 61984	nl-54190
CSA DEKRA Certification B.V.	C22.2	1465035
UL Underwriters Laboratories Inc.	UL 1977	E 45171

Declarations of conformity and manufacturer's declarations



Approval	Standard	Certificate Name
Railway WAGO GmbH & Co. KG	-	Railway Ready

Approvals for marine applications



Approval	Standard	Certificate Name
ABS American Bureau of Ship- ping	-	24-0095975-PDA
DNV DNV GL SE	-	TAE000016Z
LR Lloyds Register	IEC 61984	96/20035 (E5)
PRS Polski Rejestr Statków	-	TE/1095/880590/23

Downloads

Environmental Product Compliance

Compliance Search
Environmental Product Compliance 734-104

Documentation

Additional Information
Technical Section 03.04.2019 pdf 2027.26 KB

CAD/CAE-Data

CAD data
2D/3D Models 734-104

CAE data
EPLAN Data Portal 734-104
ZUKEN Portal 734-104

1 Compatible Products

1.1 System counterpart

1.1.1 Distribution connector



Item No.: 734-364
2-conductor combi strip; 100% protected against mismatching; 1.5 mm²; 4-pole; Pin spacing 3.5 mm; light gray















Item No.: 734-364/037-000
2-conductor combi strip; 100% protected against mismatching; 1.5 mm²; Locking lever; 4-pole; Pin spacing 3.5 mm; light gray



Item No.: 734-364/008-000
2-conductor combi strip; 100% protected against mismatching; Snap-in mounting feet; 1.5 mm²; 4-pole; Pin spacing 3.5 mm; light gray





1.1.2 Male connector/plug

 Item No.: 734-304/019-000 1-conductor male connector; CAGE CLAMP®; 1.5 mm²; Pin spacing 3.5 mm; 4-pole; 100% protected against mismatching; clamping collar; light gray	 Item No.: 734-304/018-000 1-conductor male connector; CAGE CLAMP®; 1.5 mm²; Pin spacing 3.5 mm; 4-pole; 100% protected against mismatching; DIN-35 rail/panel mounting; Snap-in mounting feet; 1,50 mm²; light gray	 Item No.: 734-304 1-conductor male connector; CAGE CLAMP®; 1.5 mm²; Pin spacing 3.5 mm; 4-pole; 100% protected against mismatching; light gray	 Item No.: 734-164/105-604/997-405 THR male header; 1.0 x 1.0 mm solder pin; angled; 100% protected against mismatching; in tape-and-reel packaging; Pin spacing 3.5 mm; 4-pole; black
 Item No.: 734-164/105-604 THR male header; 1.0 x 1.0 mm solder pin; angled; 100% protected against mismatching; Pin spacing 3.5 mm; 4-pole; black	 Item No.: 734-134/105-604/997-405 THR male header; 1.0 x 1.0 mm solder pin; straight; 100% protected against mismatching; in tape-and-reel packaging; Pin spacing 3.5 mm; 4-pole; black	 Item No.: 734-134/105-604 THR male header; 1.0 x 1.0 mm solder pin; straight; 100% protected against mismatching; Pin spacing 3.5 mm; 4-pole; black	 Item No.: 734-404 THT double-deck male header; 1.0 x 1.0 mm solder pin; angled; 100% protected against mismatching; Pin spacing 3.5 mm; 8-pole; light gray
 Item No.: 734-404/001-000 THT double-deck male header; 1.0 x 1.0 mm solder pin; angled; 100% protected against mismatching; Pin spacing 3.5 mm; 8-pole; light gray	 Item No.: 734-164 THT male header; 1.0 x 1.0 mm solder pin; angled; 100% protected against mismatching; Pin spacing 3.5 mm; 4-pole; light gray	 Item No.: 734-134/010-000 THT male header; 1.0 x 1.0 mm solder pin; straight; 100% protected against mismatching; Gold-plated contacts; Pin spacing 3.5 mm; 4-pole; light gray	 Item No.: 734-134 THT male header; 1.0 x 1.0 mm solder pin; straight; 100% protected against mismatching; Pin spacing 3.5 mm; 4-pole; light gray
 Item No.: 734-134/046-000 THT male header; 1.0 x 1.0 mm solder pin; straight; 100% protected against mismatching; Pin spacing 3.5 mm; 4-pole; light gray			

1.2 Optional Accessories

1.2.1 Ferrule

1.2.1.1 Ferrule

 Item No.: 216-301 Ferrule; Sleeve for 0.25 mm² / AWG 24; insulated; electro-tin plated; yellow	 Item No.: 216-321 Ferrule; Sleeve for 0.25 mm² / AWG 24; insulated; electro-tin plated; yellow	 Item No.: 216-131 Ferrule; Sleeve for 0.25 mm² / AWG 24; uninsulated; electro-tin plated; silver-colored	 Item No.: 216-302 Ferrule; Sleeve for 0.34 mm² / 22 AWG; insulated; electro-tin plated; light turquoise
 Item No.: 216-322 Ferrule; Sleeve for 0.34 mm² / 22 AWG; insulated; electro-tin plated; light turquoise	 Item No.: 216-132 Ferrule; Sleeve for 0.34 mm² / AWG 24; uninsulated; electro-tin plated	 Item No.: 216-201 Ferrule; Sleeve for 0.5 mm² / 20 AWG; insulated; electro-tin plated; electrolytic copper; acc. to DIN 46228, Part 4/09.90; white	 Item No.: 216-241 Ferrule; Sleeve for 0.5 mm² / 20 AWG; insulated; electro-tin plated; electrolytic copper; gastight crimped; acc. to DIN 46228, Part 4/09.90; white
 Item No.: 216-221 Ferrule; Sleeve for 0.5 mm² / 20 AWG; insulated; electro-tin plated; white	 Item No.: 216-141 Ferrule; Sleeve for 0.5 mm² / 20 AWG; uninsulated; electro-tin plated; electrolytic copper; gastight crimped; acc. to DIN 46228, Part 1/08.92	 Item No.: 216-101 Ferrule; Sleeve for 0.5 mm² / AWG 22; uninsulated; electro-tin plated; silver-colored	 Item No.: 216-121 Ferrule; Sleeve for 0.5 mm² / AWG 22; uninsulated; electro-tin plated; silver-colored
 Item No.: 216-242 Ferrule; Sleeve for 0.75 mm² / 18 AWG; insulated; electro-tin plated; electrolytic copper; gastight crimped; acc. to DIN 46228, Part 4/09.90; gray	 Item No.: 216-262 Ferrule; Sleeve for 0.75 mm² / 18 AWG; insulated; electro-tin plated; electrolytic copper; gastight crimped; acc. to DIN 46228, Part 4/09.90; gray	 Item No.: 216-202 Ferrule; Sleeve for 0.75 mm² / 18 AWG; insulated; electro-tin plated; gray	 Item No.: 216-222 Ferrule; Sleeve for 0.75 mm² / 18 AWG; insulated; electro-tin plated; gray
 Item No.: 216-142 Ferrule; Sleeve for 0.75 mm² / 18 AWG; uninsulated; electro-tin plated; electrolytic copper; gastight crimped; acc. to DIN 46228, Part 1/08.92	 Item No.: 216-102 Ferrule; Sleeve for 0.75 mm² / AWG 20; uninsulated; electro-tin plated; silver-colored	 Item No.: 216-122 Ferrule; Sleeve for 0.75 mm² / AWG 20; uninsulated; electro-tin plated; silver-colored	 Item No.: 216-243 Ferrule; Sleeve for 1 mm² / AWG 18; insulated; electro-tin plated; electrolytic copper; gastight crimped; acc. to DIN 46228, Part 4/09.90; red

1.2.1.1 Ferrule



Item No.: 216-263

Ferrule; Sleeve for 1 mm² / AWG 18; insulated; electro-tin plated; electrolytic copper; gastight crimped; acc. to DIN 46228, Part 4/09.90; red

Item No.: 216-203

Ferrule; Sleeve for 1 mm² / AWG 18; insulated; electro-tin plated; red

Item No.: 216-223

Ferrule; Sleeve for 1 mm² / AWG 18; insulated; electro-tin plated; red

Item No.: 216-103

Ferrule; Sleeve for 1 mm² / AWG 18; un-insulated; electro-tin plated



Item No.: 216-143

Ferrule; Sleeve for 1 mm² / AWG 18; un-insulated; electro-tin plated; electrolytic copper; gastight crimped; acc. to DIN 46228, Part 1/08.92

Item No.: 216-123

Ferrule; Sleeve for 1 mm² / AWG 18; un-insulated; electro-tin plated; silver-colored

Item No.: 216-204

Ferrule; Sleeve for 1.5 mm² / AWG 16; insulated; electro-tin plated; black

Item No.: 216-224

Ferrule; Sleeve for 1.5 mm² / AWG 16; insulated; electro-tin plated; black



Item No.: 216-244

Ferrule; Sleeve for 1.5 mm² / AWG 16; insulated; electro-tin plated; electrolytic copper; gastight crimped; acc. to DIN 46228, Part 4/09.90; black

Item No.: 216-264

Ferrule; Sleeve for 1.5 mm² / AWG 16; insulated; electro-tin plated; electrolytic copper; gastight crimped; acc. to DIN 46228, Part 4/09.90; black

Item No.: 216-284

Ferrule; Sleeve for 1.5 mm² / AWG 16; insulated; electro-tin plated; electrolytic copper; gastight crimped; acc. to DIN 46228, Part 4/09.90; black

Item No.: 216-124

Ferrule; Sleeve for 1.5 mm² / AWG 16; un-insulated; electro-tin plated



Item No.: 216-144

Ferrule; Sleeve for 1.5 mm² / AWG 16; un-insulated; electro-tin plated; electrolytic copper; gastight crimped; acc. to DIN 46228, Part 1/08.92; silver-colored

Item No.: 216-104

Ferrule; Sleeve for 1.5 mm² / AWG 16; un-insulated; electro-tin plated; silver-colored

1.2.2 Insulation stop

1.2.2.1 Insulation stop



Item No.: 734-671

Insulation stop; 0.08 - 0.2 mm² "s" (0.14 mm² "f-st"); 8 pieces/strip; light gray

1.2.3 Marking

1.2.3.1 Marking strip



Item No.: 210-332/350-202

Marking strips; as a DIN A4 sheet; MARKED; 1-16 (240x); Height of marker strip: 3 mm; Strip length 182 mm; Horizontal marking; Self-adhesive; white

Item No.: 210-332/350-204

Marking strips; as a DIN A4 sheet; MARKED; 17-32 (240x); Height of marker strip: 3 mm; Strip length 182 mm; Horizontal marking; Self-adhesive; white

Item No.: 210-332/350-206

Marking strips; as a DIN A4 sheet; MARKED; 33-48 (240x); Height of marker strip: 3 mm; Strip length 182 mm; Horizontal marking; Self-adhesive; white

1.2.4 Strain relief

1.2.4.1 Strain relief housing



Item No.: 734-604

Strain relief housing; for female and male connectors; 2 parts; Pin spacing 3.5 mm; 4-pole; light gray

1.2.4.2 Strain relief plate

Item No.: 734-127

Strain relief plate; for female and male connectors; 6 mm wide; 1 part; Pin spacing 3.5 mm; light gray

1.2.5 Test and measurement

1.2.5.1 Testing accessories



Item No.: 735-500

WAGO Test pin; 1 mm Ø; 30 V AC / 60 V DC; CAT0; 1 A; 6 mm uninsulated; Test lead for soldering up to 0,5mm²

1.2.6 Tool

1.2.6.1 Operating tool



Item No.: 734-190

Combination operating tool; natural



Item No.: 734-231

Operating tool; black



Item No.: 210-719

Operating tool; Blade: 2.5 x 0.4 mm; with a partially insulated shaft



Item No.: 210-647

Operating tool; Blade: 2.5 x 0.4 mm; with a partially insulated shaft; multicoloured



Item No.: 210-251

Operating tool; for MCS MICRO and MINI with CAGE CLAMP® connection; yellow



Item No.: 210-250

Operating tool; for MCS MINI and MIDI with CAGE CLAMP® connection; red



Item No.: 734-191

Operating tool; made of insulating material; 1-way; loose; black



Item No.: 734-230

Operating tool; made of insulating material; 1-way; white

Installation Notes

Conductor termination

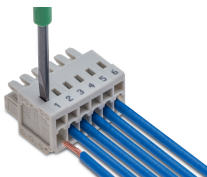

Inserting a conductor via (2.5 x 0.4) mm screwdriver – CAGE CLAMP® actuation perpendicular to conductor entry.



Inserting a conductor via (2.5 x 0.4) mm screwdriver – CAGE CLAMP® actuation parallel to conductor entry.

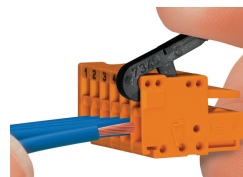

Inserting a conductor into CAGE CLAMP® unit via operating tool (734-191).

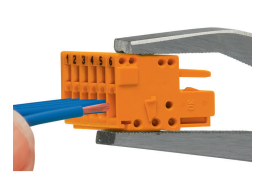

Inserting a conductor into CAGE CLAMP® unit via operating tool (210-251 or 210-250).

Coding



Coding a female connector – removing coding finger(s).

Testing



Testing via 1 mm Ø test pin (735-500) – CAGE CLAMP® connection – touch contact.

Marking

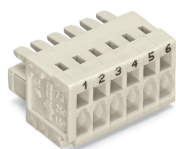

Labeling via direct marking or self-adhesive strips.

Installation

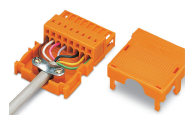

Strain relief housing for 734 Series Male and Female Connectors with CAGE CLAMP® connection