

---

USER GUIDE

MAN0133 rev 28

# CXpro<sup>HD</sup>



## Style conventions used in this document:

**UI Text:** Text that represents elements of the UI such as button names, menu options etc. is presented with a grey background and border, in Tahoma font which is traditionally used in Windows UIs. For example:

Ok

**Standard Terms (Jargon):** Text that is not English Language but instead refers to industry standard concepts such as Strategy, BACnet, or Analog Input is represents in slightly condensed font. For example:

BACnet

**Code:** Text that represents File paths, Code snippets or text file configuration settings is presented in fixed-width font, with a grey background and border. For example:

```
$config_file = c:\CYLON\settings\config.txt
```

**Parameter values:** Text that represents values to be entered into UI fields or displayed in dialogs is represented in fixed-width font with a shaded background. For example

10°C

**Product Names:** Text that represents a product name is represented in bold colored text. For example

INTEGRA™

**Company Brand names:** Brands that are not product names are represented by bold slightly compressed text:

ABB Active Energy

**PC Keyboard keys:** Text representing an instruction to press a particular key on the keyboard is enclosed in square brackets and in bold font. For example:

[Ctrl]+[1]

<b>1</b>	<b>ABB CYLON® BUILDING MANAGEMENT SYSTEM</b>	
	<b>Hardware Components</b> .....	<b>9</b>
	Routers .....	9
	I/O Field Controllers.....	9
	PC.....	9
	Connections between hardware components.....	9
	<b>Software Components</b> .....	<b>10</b>
	CXpro <sup>HD</sup> modules.....	10
	<b>CXpro<sup>HD</sup> – Overview</b> .....	<b>11</b>
<b>2</b>	<b>BASIC TASKS</b>	
	<b>Starting CXpro<sup>HD</sup></b> .....	<b>12</b>
	<b>The CXpro<sup>HD</sup> Interface</b> .....	<b>13</b>
	The Site List .....	13
	The Strategy Drawing Area .....	13
	The Right-Hand Pane (Inspector).....	13
	The Ribbon .....	14
	The Quick Access toolbar .....	14
	<b>Connecting to a Field Controller</b> .....	<b>15</b>
	<b>Opening Strategy files</b> .....	<b>15</b>
	<b>Navigating a multi-page strategy</b> .....	<b>16</b>
	Labeling the pages within a strategy drawing.....	17
	<b>Finding an element in a strategy</b> .....	<b>20</b>
	<b>Zooming and Navigating the drawing area</b> .....	<b>20</b>
	<b>Changing the display</b> .....	<b>21</b>
	<b>Modifying the Drawing Area (Grid settings)</b> .....	<b>22</b>
	<b>Modifying display colour settings</b> .....	<b>22</b>
	<b>Saving Files</b> .....	<b>23</b>
	Saving a new file.....	23
	Saving changes to an existing file.....	24
	Saving more than one file.....	24
	<b>Printing</b> .....	<b>25</b>
	Including a footer in a printed strategy.....	25
	Altering the print set-up.....	26
	Printing a file.....	27
	Changing the size of a Printout .....	27
	Fitting a Strategy to a page size when printing.....	28
	<b>Closing files</b> .....	<b>29</b>
<b>3</b>	<b>SYSTEM CONFIGURATION</b>	
	<b>System Configuration definitions</b> .....	<b>30</b>
	<b>Configuring Sites</b> .....	<b>30</b>
	Defining the contents of a site .....	31
	<b>Configuring Serial Port Connection</b> .....	<b>43</b>
	<b>Configuring Strategy Defaults</b> .....	<b>44</b>
	<b>Configuring BACnet Communications</b> .....	<b>44</b>
	Configuring BBMD .....	46

	Configuring Site Communications (Commands).....	49
4	<b>USING MODULES</b>	
	<b>Modules - Overview .....</b>	<b>51</b>
	<b>Accessing Modules .....</b>	<b>51</b>
	<b>Placing a module on the drawing area.....</b>	<b>53</b>
	Selecting modules on the drawing area.....	56
	Move, Delete, Cut or Copy a module or modules on the Strategy drawing area .....	57
	Tool Tip Data on Modules.....	58
	<b>Joining modules in a strategy.....</b>	<b>59</b>
	Module connection points.....	59
	How to join modules.....	59
	How connections are represented.....	60
	Connectors.....	62
	Viewing Point properties .....	65
	Viewing BACnet properties .....	65
	<b>How to add text to a strategy.....</b>	<b>68</b>
	How to change text that has been added to the strategy drawing.....	69
	<b>Virtual modules.....</b>	<b>70</b>
	Placing Virtual modules on the drawing area .....	70
	Rules for connecting to virtual modules .....	71
	Numbering virtual modules .....	71
	Virtual modules in macros.....	71
5	<b>POINTS AND POINT VALUES</b>	
	<b>What are points? .....</b>	<b>72</b>
	<b>What are blocks? .....</b>	<b>72</b>
	<b>Block Numbers.....</b>	<b>72</b>
	<b>Point Numbers.....</b>	<b>73</b>
	<b>Defining hardware points .....</b>	<b>74</b>
	How to define hardware points.....	74
	Summary of procedure for defining hardware points.....	77
	Point numbers for inputs and outputs.....	77
	A short cut to defining hardware points.....	78
	<b>What are UniPuts™? .....</b>	<b>79</b>
	<b>Configuring the Field Controller’s Inputs and Outputs .....</b>	<b>79</b>
	How to open the "I/O Terminals" dialog.....	79
	Changing the configuration of a UniPut™ or Universal Input .....	82
	Viewing used blocks.....	85
	<b>Keeping CXpro<sup>HD</sup> and Controller strategies in Sync .....</b>	<b>87</b>
	Strategy Compare.....	87
	Strategy Synchronization .....	89
	<b>Reading Live point values (LiveLog) .....</b>	<b>91</b>
	Configuring Live Log.....	91
	Running LiveLog.....	92
	LiveLog - Scanning Definition .....	93
	<b>Manually Overriding Point Values - the Override Point dialog .....</b>	<b>94</b>
	Overriding points .....	94
	Using the Override Point dialog.....	95
	<b>How to Enable a hardware point value (remove manual override status) 97</b>	

How to change the value of a Setpoint..... 98

Manually Changing a Multi-state Value..... 99

6 CREATING STRATEGIES

What is a strategy? ..... 100

An example of a strategy ..... 100

How to Create a Strategy..... 101

Place all the required modules on the drawing area and join them..... 104

Creating Strategies - Set the values of the module's Constants ..... 108

Creating Strategies - Add explanatory text if necessary ..... 108

How to reorder blocks in a Strategy..... 108

How to Upload Setpoint Values ..... 110

Naming strategy Files ..... 110

How to open an existing strategy:..... 111

Strategy Associations..... 112

What is an "Associated" Strategy? ..... 112

Creating Associations..... 112

Breaking Associations ..... 112

Copying associated strategies ..... 113

Importing a Strategy..... 113

Opening multiple strategies ..... 114

Downloading a strategy ..... 115

Starting a strategy (sending the Setup)..... 120

Testing a strategy with Scan Mode ..... 122

Preparing to test a strategy..... 122

How to test a strategy ..... 122

Suggestions for testing strategies..... 124

Securing CBM data ..... 125

How to password-protect a range of blocks in a CBM strategy..... 125

How to access locked strategy blocks..... 126

How to expose Points on a BACnet system..... 127

How to View BACnet points from A Controller ..... 128

7 NAMING OBJECTS

Why objects are named ..... 129

Rules for naming objects ..... 129

Procedures for naming objects ..... 129

Naming Points ..... 129

Naming Field Controller time schedules ..... 130

Naming datalogs..... 130

8 USING MACROS

Macros - Overview..... 132

Macros and Macro Templates..... 132

Macro structure..... 132

Macro Description (Help) Files ..... 132

	<b>How to Create a Macro Template .....</b>	<b>133</b>
	Create the strategy.....	133
	Select the modules for the macro.....	134
	Add the selected modules to the Macro Template.....	135
	Define the Macro Inputs, Outputs, Group and Name (the Create Macro dialog box).....	137
	Choose whether to insert the macro into the active strategy.....	141
	Save the Macro Template .....	141
	<b>How to create a new macro group and sub-group.....</b>	<b>143</b>
	<b>How to rename points in a Macro Template .....</b>	<b>145</b>
	<b>How to Set Macro Setpoint Unit LaBels .....</b>	<b>146</b>
	<b>How to transfer macros from one computer to another .....</b>	<b>148</b>
	Export macros from the PC on which they were created .....	148
	Add exported Macros to the host PC system.....	149
	<b>Working with Macros .....</b>	<b>150</b>
	How to insert a macro into a strategy.....	150
	How to view the modules in a macro ("Expanding" a macro).....	152
	How to Edit a Macro.....	153
<b>9</b>	<b>COMMUNICATING WITH CONTROLLERS</b>	
	<b>Communicating with ABB Cylon® Controllers .....</b>	<b>154</b>
	<b>Sending information to a Field Controller .....</b>	<b>154</b>
	Wiping a Field Controller's memory.....	154
	Sending the setup to a Field Controller .....	154
	<b>Getting Controller Information .....</b>	<b>154</b>
	How to get the Controller version.....	154
	How to get the controller setup .....	156
	How to get controller statistics.....	157
	How to get Field Controller Diagnostic information.....	161
	How to get Field Controller Configuration information.....	161
	<b>How to set the Controller Time and Date .....</b>	<b>162</b>
	<b>Changing the address of a controller (CBM only) .....</b>	<b>163</b>
<b>10</b>	<b>DATALOGS AND ALARMS</b>	
	<b>Datalogs .....</b>	<b>164</b>
	The datalog function module.....	164
	Restrictions on the use of datalogs.....	164
	Standard Datalog sampling period .....	164
	Time Stamped Datalogs .....	164
	Datalog sampling of digital and analog point values.....	165
	How to define a datalog .....	165
	Starting a datalog.....	167
	Viewing the contents of a datalog.....	168
	<b>Alarms .....</b>	<b>169</b>
	Starting alarms .....	169
	Examples of Strategies containing alarms .....	169
<b>11</b>	<b>SIMULATION MODE</b>	
	<b>Introduction .....</b>	<b>170</b>
	<b>Configuring the Simulation .....</b>	<b>171</b>
	The Simulation Cycle.....	171

	Current simulation configuration .....	171
	<b>Running a Simulation .....</b>	<b>172</b>
	Livelog .....	172
	<b>Point properties .....</b>	<b>173</b>
	Accessing the points properties.....	173
	Point value override.....	174
	Input point options .....	175
	<b>Point logging.....</b>	<b>179</b>
12	<b>SITES</b>	
	<b>Overview.....</b>	<b>180</b>
	<b>Installing a new site on the PC.....</b>	<b>180</b>
	<b>What happens when a new site is installed .....</b>	<b>180</b>
	<b>How a new site is installed on the PC.....</b>	<b>180</b>
	<b>Site backup.....</b>	<b>180</b>
	Making a site backup .....	181
	Restoring a Site from a backup file.....	182
	<b>Site Discovery .....</b>	<b>183</b>
	If the Site is not yet configured in the Site Tree.....	183
	If the Site is already configured in the Site Tree .....	184
	<b>Full Upload and Download .....</b>	<b>186</b>
	Download .....	186
	Upload .....	188
	SMART Router Controller Replacement (web page).....	190
	<b>Batch Upload and Download.....</b>	<b>192</b>
	Batch Download .....	192
	Batch Upload.....	194
	<b>Viewing the Audit log.....</b>	<b>195</b>
	<b>Firmware Upgrade.....</b>	<b>196</b>
	<b>Upgrade Sensors to Fusion Air .....</b>	<b>199</b>
	<b>ASPECT® / INTEGRA™ Export .....</b>	<b>200</b>
	Starting the Export.....	200
	Import into ASPECT®-Studio and INTEGRA™-ProPack.....	201
	<b>Aero<sup>CT</sup> Configuration.....</b>	<b>203</b>
	Setpoints To Configure.....	203
	Tuning Graphs.....	204
13	<b>APPENDIX :: CONFIGURING UNITS OF MEASUREMENT AND STATE STRINGS</b>	
	<b>Adding units of measurement .....</b>	<b>205</b>
	How to add units of measurement to the system.....	205
	Example of adding units to analog units list.....	206
	<b>Configuring State Text strings .....</b>	<b>207</b>
14	<b>APPENDIX :: FILE MANAGEMENT</b>	
	<b>File Management in CXpro<sup>HD</sup> .....</b>	<b>208</b>
15	<b>APPENDIX :: BACNET EXPLORERS</b>	

	<b>NB-Pro</b> .....	209
	<b>Discovery Tool</b> .....	209
	BACnet Explorer.....	209
	Check Against Existing Devices .....	215
	Changing the Present_Value Property .....	215
16	<b>COMMISSIONING CONTROLLERS WITH CXPRO<sup>HD</sup></b>	
	<b>How to Configure a Controller's BACnet settings</b> .....	216
	<b>Commissioning a range of controllers quickly (Mass Commissioning)</b> .....	218
	Configure a single controller .....	221
	<b>Configure IP BACnet Device Properties</b> .....	222
	How to Associate devices.....	222



# 1 ABB Cylon<sup>®</sup> Building Management System

The **ABB Cylon<sup>®</sup> BACnet** Building Management System is made up of several components, which fall into two main categories:

- **Hardware** - the products that monitor and control a building's environment.
- **Software** - the interface which allows users to configure and monitor **ABB Cylon<sup>®</sup> Hardware**.

## HARDWARE COMPONENTS

**ABB Cylon<sup>®</sup> BACnet** uses the following main hardware components:

- Routers.
- I/O Field Controllers.
- Keypad
- PC

There may also be other supplementary hardware components such as printers, modems, pagers, etc., but these are not essential to the basic system.

### ROUTERS

**CBR** devices route communications between BACnet IP and BACnet MS/TP networks.

**Aspect<sup>®</sup> MATRIX Series** and **NEXUS Series** devices are programmable communications controllers, which provide supervision of **ABB Cylon<sup>®</sup> BACnet** networks and route communications between BACnet IP and BACnet MS/TP networks.

3rd-party BACnet Routers can also be used with the **ABB Cylon<sup>®</sup> BACnet** system.

### I/O FIELD CONTROLLERS

**CBM** and **CBT** Field Controllers take inputs from sensors and Building Control plant and send output to Building Control plant in response. They are available as programmable or unitary controllers, with various input/output configurations.

These I/O controllers can be programmed with strategies, which configure them to send specific outputs to connected devices in response to events occurring on their inputs. For example, you can create a Strategy in **CXpro<sup>HD</sup>** and download it to a Field Controller specifying that a valve is opened if the temperature being input to the controller rises above a predetermined level.

**ABB Cylon<sup>®</sup> Field controllers** are networked together using RS485 by BACnet Routers, which in turn are networked by Ethernet. A Field Controller can also be linked directly to a PC, as well as to a modem or a printer.

### PC

The PC is connected to an **ABB Cylon<sup>®</sup>** network by Ethernet, RS232, or modem connection. The PC can also be connected directly to a Field Controller for small installations with stand-alone controllers.

**CXpro<sup>HD</sup>** software - which is used to configure the controllers, schedule events, and extract reports - is run on the PC., which must have **Windows 10 Professional 64-bit** and **Windows 7 Professional / Enterprise / Ultimate 64-bit** installed and running.

The minimum configuration to run this application is: **Core 2 Duo E6300, 1Gb RAM, 80Gb hard drive.**

The recommended configuration is: **Core 2 Duo E6600, 2Gb RAM, 160Gb hard drive.**

## CONNECTIONS BETWEEN HARDWARE COMPONENTS

The following types of connections exist between the hardware components:

- Fast Ethernet bus connecting **CBR** routers and **Aspect<sup>®</sup>** devices with the **CXpro<sup>HD</sup> PC**.
- An RS485 fieldbus, using shielded twisted pair cables, connecting the BACnet Router to the I/O controllers.

## SOFTWARE COMPONENTS

The CXpro<sup>HD</sup> suite of software applications is used to set up, maintain, and control the **ABB Cylon<sup>®</sup>** system in operation.

### CXPRO<sup>HD</sup> MODULES

The following applications are available from CXpro<sup>HD</sup> group in the Windows **Start menu**:

- **Database Interface**
- The **Database Interface** program allows you access to the database that contains details of all the point values on each Field Controller in the network. You can set point values graphically in CXpro<sup>HD</sup>, or you can enter or delete them in the **Database Interface** program.
- **Datalog Manager**
- A datalog in CXpro<sup>HD</sup> logs the value of a specified point in a Field Controller at a specified interval so that it contains a record of the changes in that point value over a period of time. The **Datalog Manager** program allows you to display the contents of a datalog in either graphic or tabular form. (see also *MAN0136 Datalog Manager User's Guide*)
- Engineering Tool
- CXpro<sup>HD</sup> is a graphical interface created for programming the **ABB Cylon<sup>®</sup>** product range. In CXpro<sup>HD</sup>, strategies (which tell a controller how its outputs should respond to conditions on its inputs) can be designed, edited and downloaded to, or uploaded from, Field Controllers. CXpro<sup>HD</sup> could be described as the most important of all the **ABB Cylon<sup>®</sup>** applications, as it is the application that programs the **ABB Cylon<sup>®</sup>** controllers. This manual describes how to carry out a variety of tasks in CXpro<sup>HD</sup>.
- Manage Software Licence
- **Site Organiser**
- The **Site Organiser** is an easy way to configure and examine a complete site or part of a site. Instead of downloading strategies individually to all the controllers on a site, this can be done in one simple task. Any combination of strategies can be downloaded to any combination of controllers or to one type of controller in a *.ins* batch file. (See also *MAN0135 Site Organiser manual*)
- Start CXpro<sup>HD</sup>

## **CXPRO<sup>HD</sup> – OVERVIEW**

CXpro<sup>HD</sup> provides all of the tools required to design, configure, test, commission, and maintain **ABB Cylon<sup>®</sup>** BACnet systems automatically.

You can use CXpro<sup>HD</sup> to:

- Graphically create strategies that implement solutions to conditions on site.
- Save those strategies for future editing, testing, or reference.
- Test the operation of strategies.
- Debug and edit strategies.
- Download strategies to the appropriate controllers.
- Define and assign 3rd party blocks to carry data across a Fieldbus.
- Define and assign wide 3rd party blocks to carry data between Fieldbusses and across the network of a site.
- Upload existing strategies from controllers.
- Upload analog and digital point values from controllers.
- Upload statistical and reference information from controllers.
- Record changes that occur on a site as they happen and save the record to a file.

## 2 Basic tasks

### STARTING CXPRO<sup>HD</sup>

Open the CXpro<sup>HD</sup> section on the Windows Start menu or start screen, or search for “CXpro<sup>HD</sup>” in the Application search box.

Click on the Start CXpro<sup>HD</sup> icon. The CXpro<sup>HD</sup> interface will open:

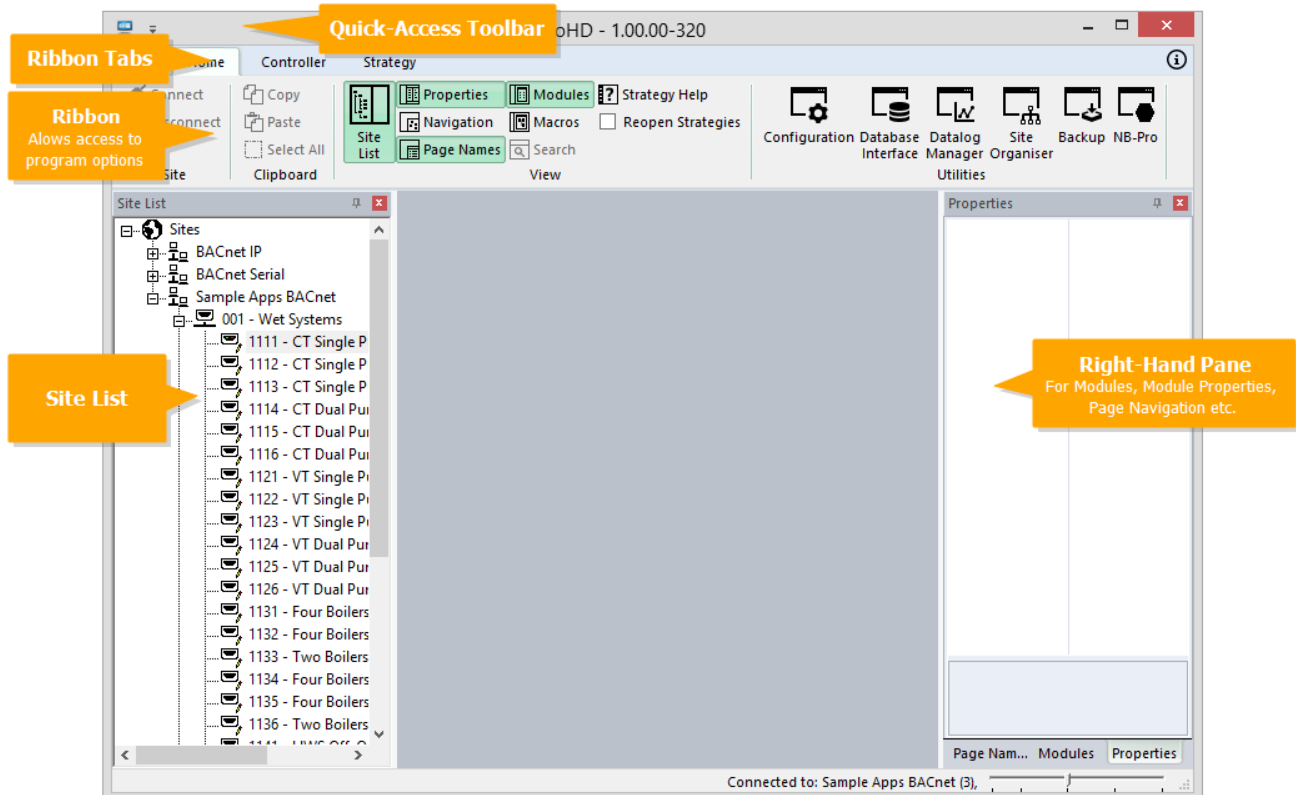

**Note:** If other ABB Cylon<sup>®</sup> Engineering Software, e.g. CEC7 is installed on the same PC, then instead of the CXpro<sup>HD</sup> interface opening directly, a “Chooser” dialog opens first allowing the user to select the software to be opened.

## THE CXPRO<sup>HD</sup> INTERFACE

The CXpro<sup>HD</sup> User Interface consists of the following sections:

### THE SITE LIST

This gives an overview of the BMS Sites that are accessible from this PC

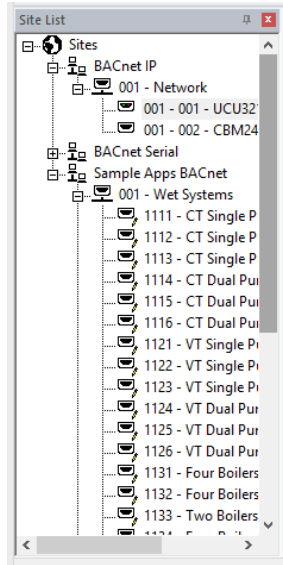

### THE STRATEGY DRAWING AREA

This part of the UI shows the modules and points in the current strategy, and the connections between them,

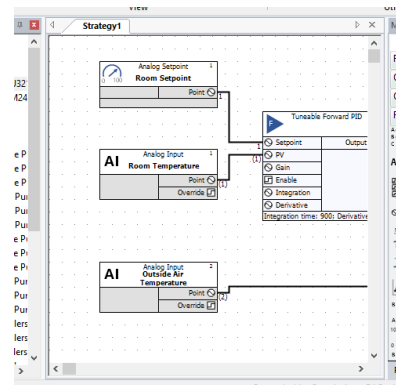

### THE RIGHT-HAND PANE (INSPECTOR)

On the right-hand side of the UI there is an area that displays the Modules library, a Module Property editor, a BACnet properties inspector and Page navigation panels.

By default, these panels are displayed one-by-one in a tabbed interface,

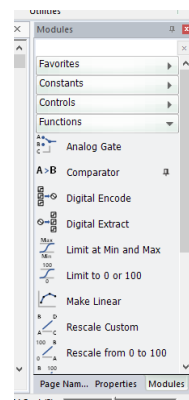

but the layout can be configured by dragging the tabs so that the panels can be displayed all together as shown here:

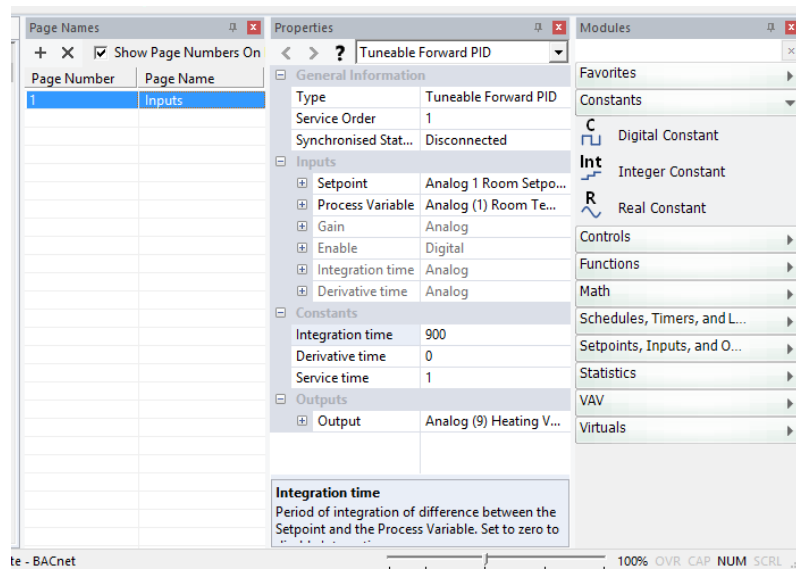

## THE RIBBON

At the top of the CXpro<sup>HD</sup> User Interface, there is a palette similar to many Windows applications called the Ribbon. The Ribbon allows access to the majority of CXpro<sup>HD</sup> features.

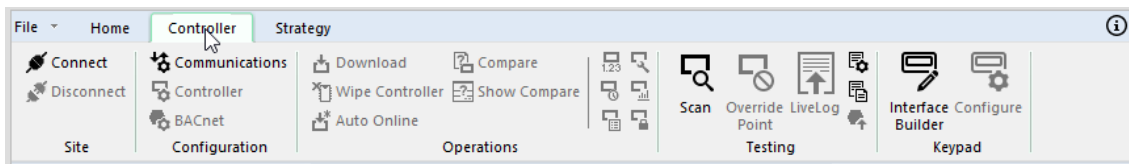

The feature options are grouped into tabs each of which contains a different set of options.

## THE QUICK ACCESS TOOLBAR

If there are specific Ribbon feature options that you use often, you can add them to the Quick Access Toolbar where they will be accessible at all times:



To do this, right-click on the feature in the Ribbon and select Add to Quick Access Toolbar:

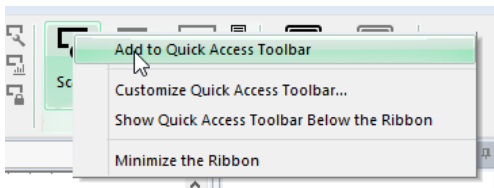

## CONNECTING TO A FIELD CONTROLLER

Work in CXpro<sup>HD</sup> can be done on-line or off-line. When on-line, the PC can communicate directly to the controller. When off-line, there is no direct link between the PC and the controller. For tasks that involve direct communication between the PC and the controller, e.g. uploading or downloading information, it is necessary to work on-line.

- To work online, you must connect to the controller by clicking on the **Connect** button in the **Home** tab of the **Ribbon**:

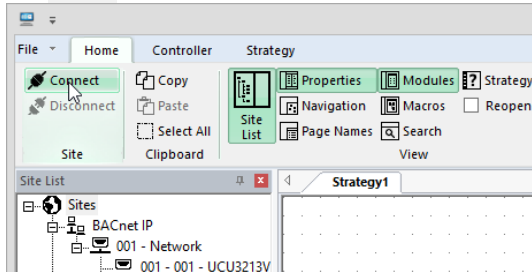

- To work off-line, click the **Disconnect** button.

## OPENING STRATEGY FILES

To open a strategy file in CXpro<sup>HD</sup>, you can

- Create a new strategy

or

- Open an existing strategy file.

It is possible to open multiple files: multiple new strategies in different controllers, multiple existing files, or a mixture of both (see page 16)

To create a new strategy, either double-click on a Field Controller in the **Site List** that does not already have a strategy associated with it or select **New** from the **File** menu

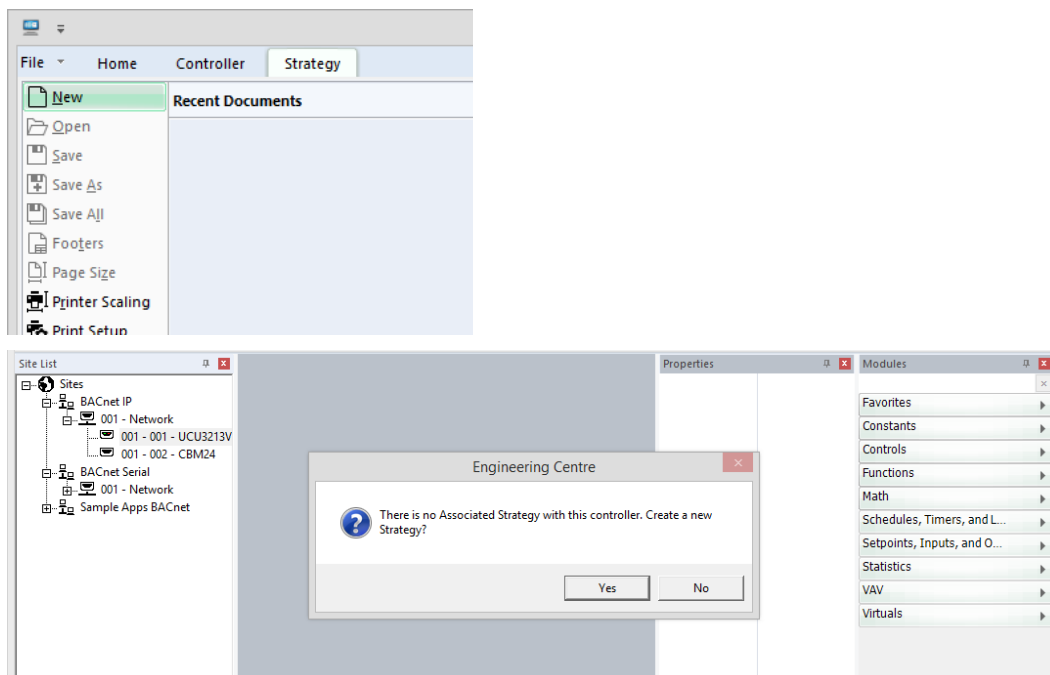

You will be asked if you want to create a new strategy – click **Yes**.

To open an existing strategy file, double-click on a Field Controller that has an associated strategy, or select **Open** from the **File** menu:

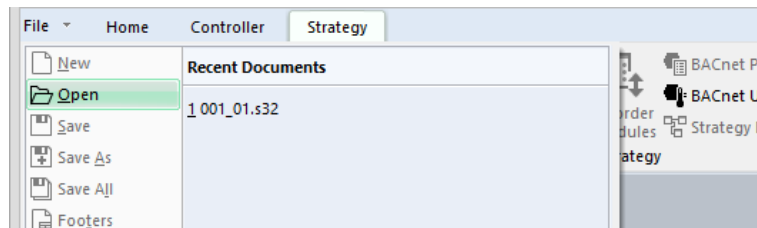

## NAVIGATING A MULTI-PAGE STRATEGY

For clarity, many strategies are drawn over several print-pages. To facilitate navigation through these pages, CXpro<sup>HD</sup> provides a Page Navigation panel.

To open it, select **Navigation** on the **Home** Ribbon.

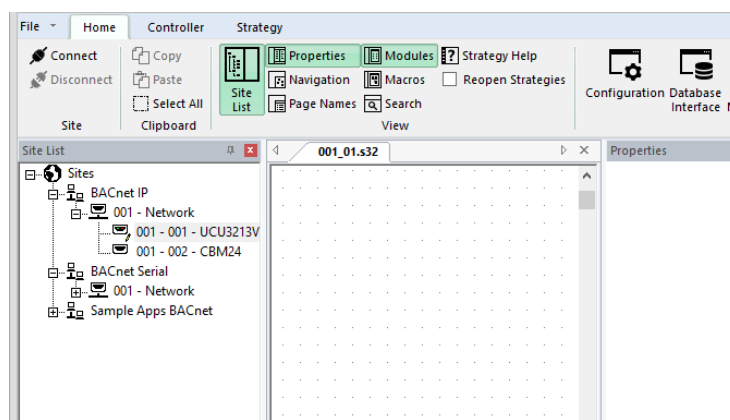

The button turns green to indicate the panel is currently displayed:

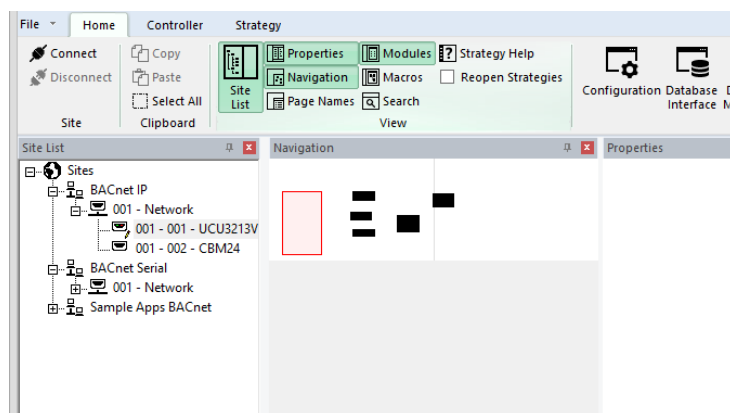

The **Navigation** panel appears by default as a docked panel within the CXpro<sup>HD</sup> window, but by dragging its title bar it can be repositioned within the window or even 'popped out' as an independent window that you can position anywhere on your monitor:



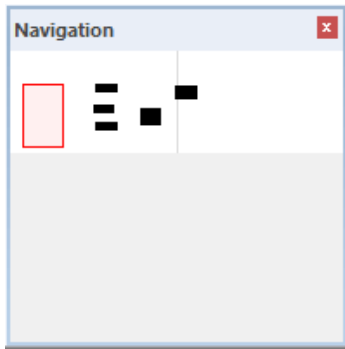

The **Navigation** panel shows black rectangles to indicate strategy blocks and a red rectangle to indicate the current **Strategy Drawing Pane**. Dragging the red rectangle moves the display within the **Strategy Drawing Pane**:

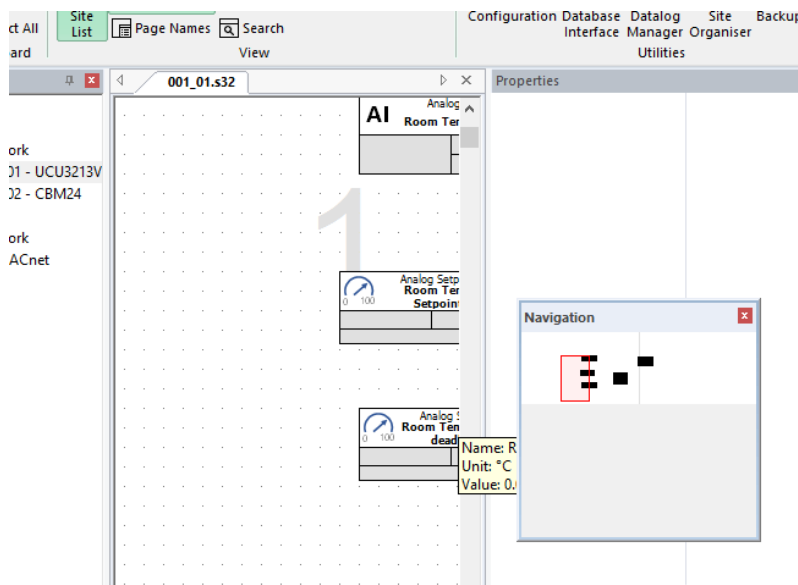

## LABELING THE PAGES WITHIN A STRATEGY DRAWING

An alternative method for navigating a large strategy is to use page names. A pane is available for this, to open it click on the **Page Names** button in the **Home** ribbon:

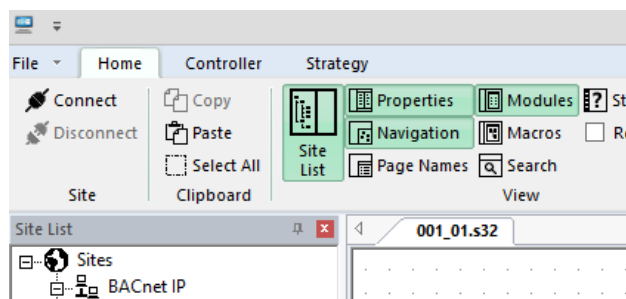

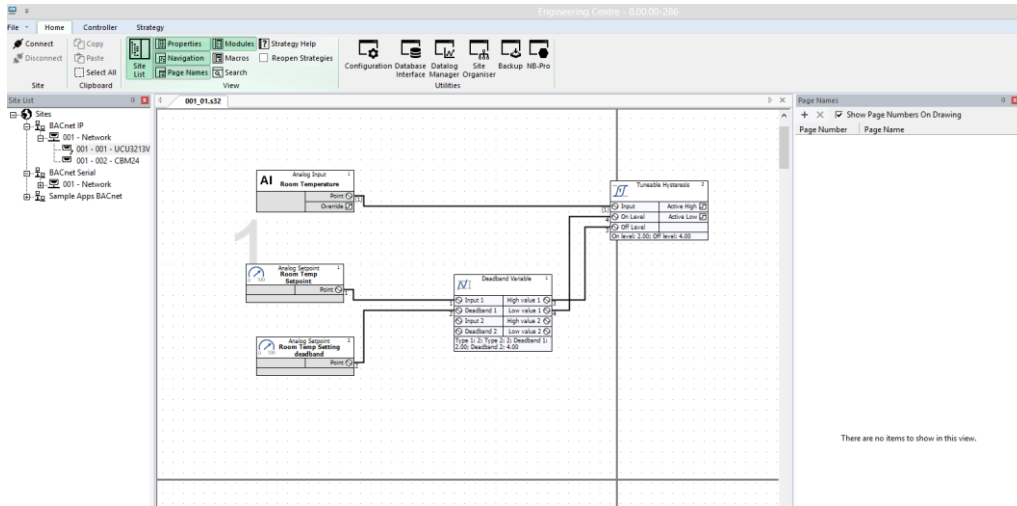

The Page Names panel appears by default as a docked panel within the CXpro<sup>HD</sup> window, but by dragging its title bar it can be repositioned within the window or even 'popped out' as an independent window that you can position anywhere on your monitor.

The Page Names pane allows you to hide the page number on the strategy drawing:

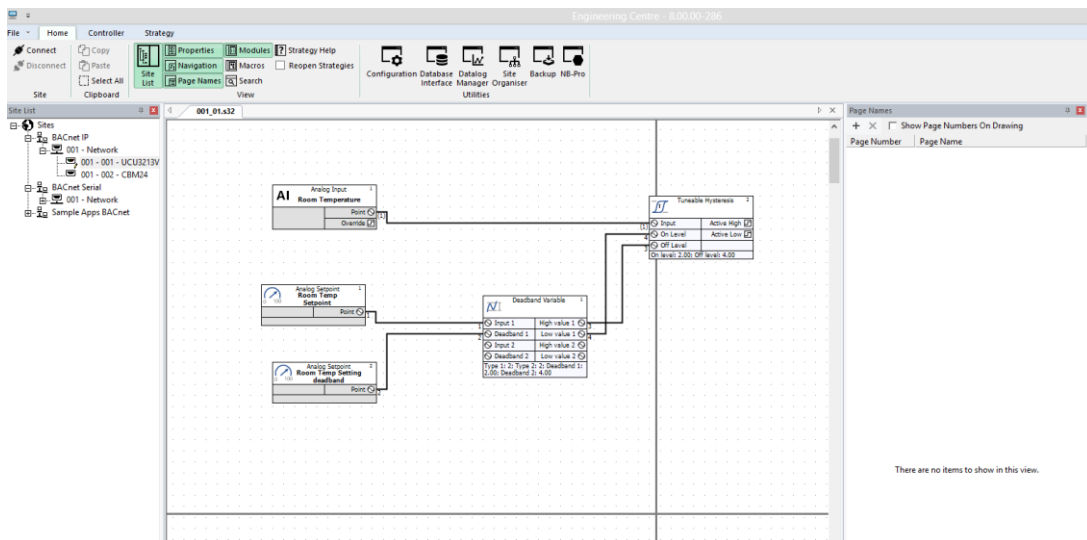

And allows you to add names for pages instead of numbers:

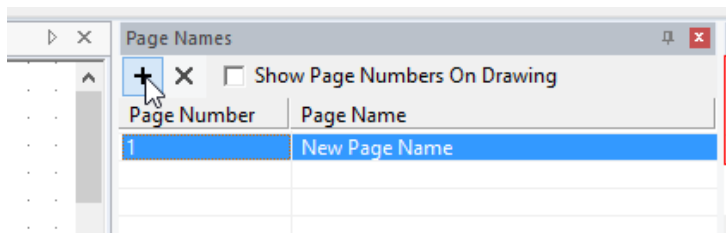

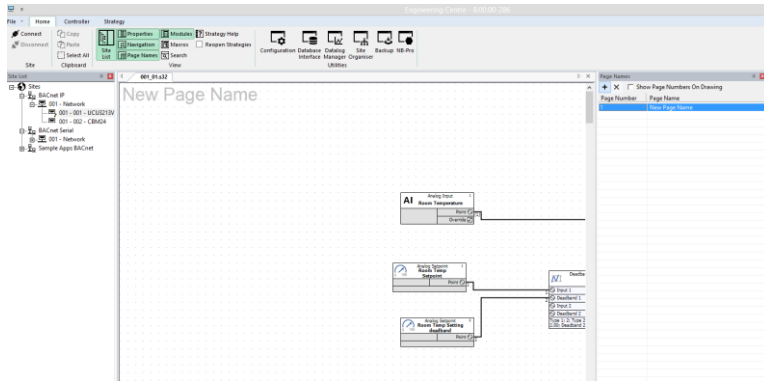

Double-click on the name in the **Page Names** pane to edit it:

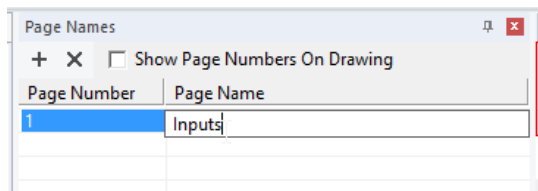

and the new name is displayed on the strategy drawing:

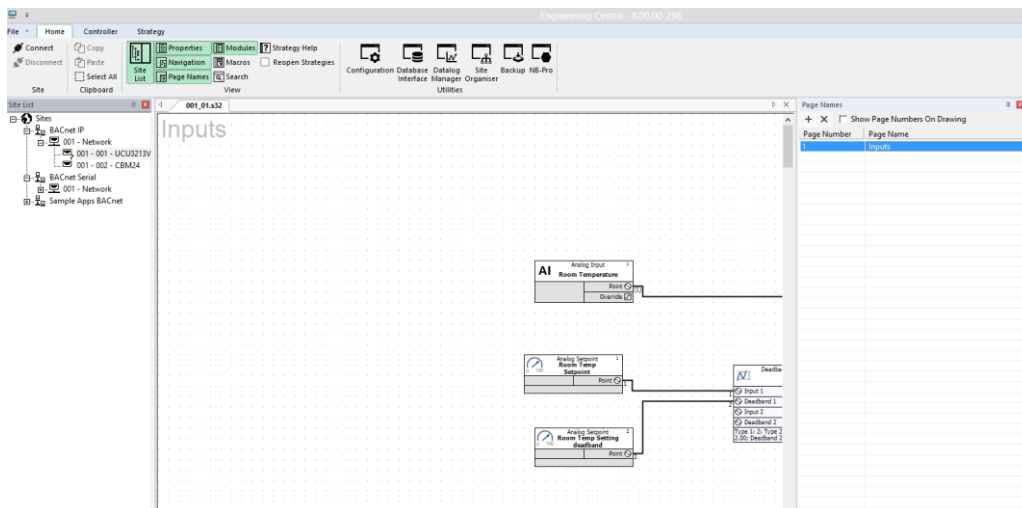

Click on a name in the **Page Names** pane to align the top left corner of that page in the top left corner of the Strategy Drawing Pane:

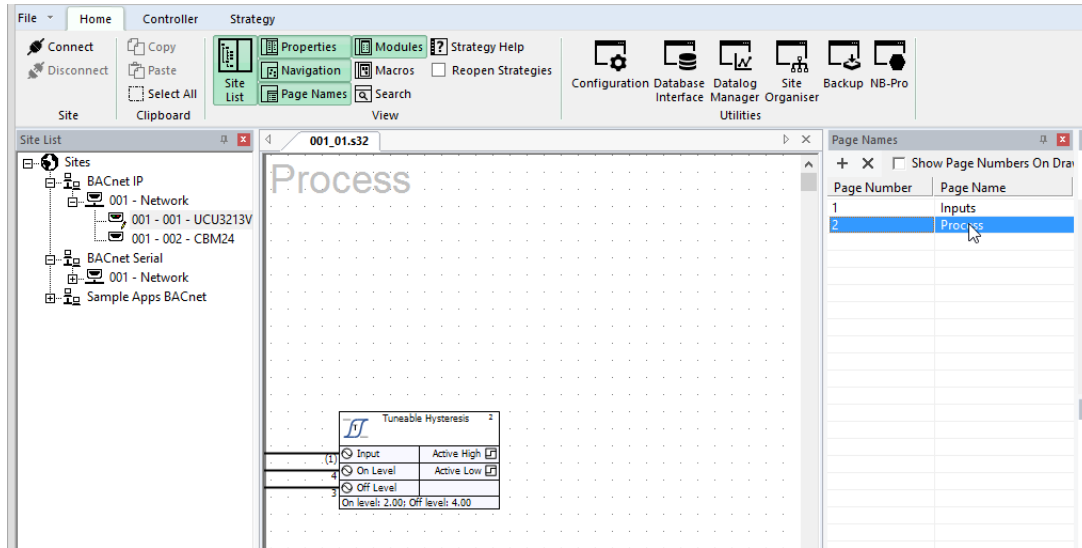

## FINDING AN ELEMENT IN A STRATEGY

CXpro<sup>HD</sup>'s Find pane is a facility for locating specific objects in a strategy,

It is opened by either pressing [Ctrl]+[F], or by selecting the search window from the Home tab of the Ribbon.

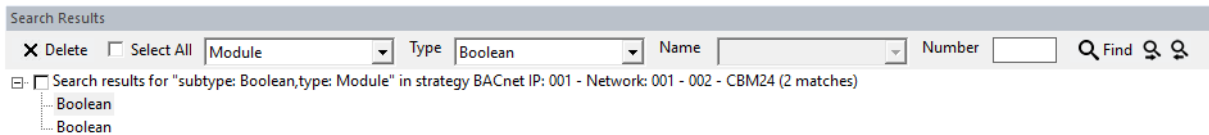

This pane contains a number of lists in which you can specify a number of filters to reduce the kinds of items that will be located – for example in the screenshot above, only Boolean modules are shown.

You can then step through all of the matching items in the strategy drawing using the mouse or arrow keys and selecting the module discovered in the search results. The current match will be highlighted in the drawing:

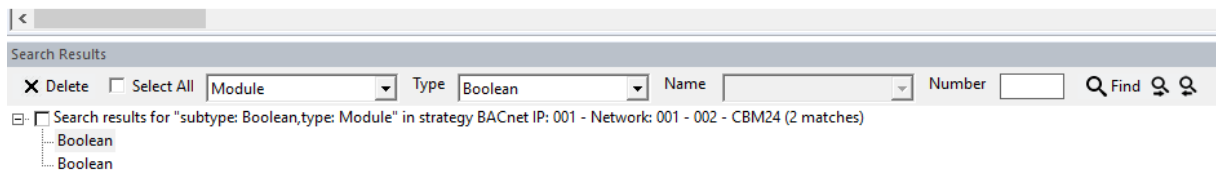
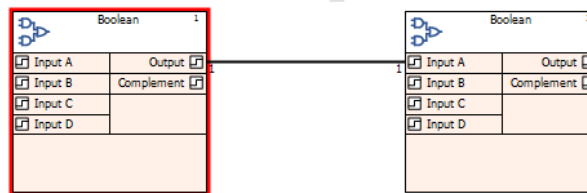

## ZOOMING AND NAVIGATING THE DRAWING AREA

The drawing area can be displayed in an enlarged or reduced view. The default view is 100 %, i.e. full size.

With a mouse, zoom in and out by rotating your mouse wheel with the control button pressed on your keyboard.

If you do not have a mouse with a mouse wheel or are using a trackpad, you may use the zoom slider at the bottom of the drawing area to zoom in and out.

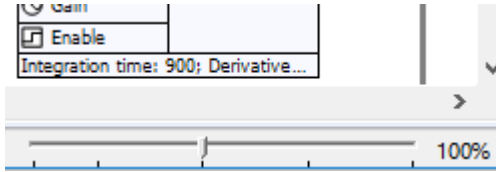

For navigating around the drawing area, you can use the scrolls located on the right and bottom of the drawing area.

The mouse wheel may also be used to move around the drawing. Scrolling up and down with the mousewheel will move the drawing up and down. Scrolling up and down with the Shift button pressed on your keyboard, you may move right and left.

You may also use the right mouse button to drag the strategy around in the drawing area.

If you are using a trackpad, the Navigation Pane makes it easy to get around your strategy.

## CHANGING THE DISPLAY

The following features of CXpro<sup>HD</sup> can be customized:

- **Drawing Area (Grid Settings).** To simplify positioning modules on the drawing area, you can choose a grid of either lines or dots. You can also customize the size of the grid from 8-pixel to 56-pixel squares (*see page 22*).
- **Colours.** The colour of either the background or the grid can be customized using the **Colour** menu option from the **Display** menu. In addition to the standard colours available, custom colours can also be defined (*see page 22*).
- **Macros.** If the work you do in CXpro<sup>HD</sup> involves repetitive strategies or parts of the strategies, you can create macros (*see page 132*) to automate much of that work. You can arrange those macros in groups and, using an art tool, such as Microsoft Paint, you can draw icons to represent the macro groups and individual macros you have created.

## MODIFYING THE DRAWING AREA (GRID SETTINGS)

From the **Strategy** tab on the **Ribbon**, choose **Grid**.

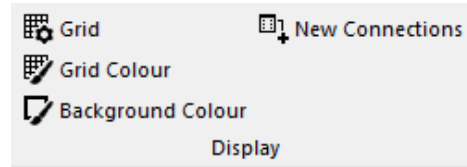

This opens the **Grid** dialog box, where you can specify whether or not to show the grid, and if it is shown, whether you prefer lines or dots. You can also set the spacing of the grid.

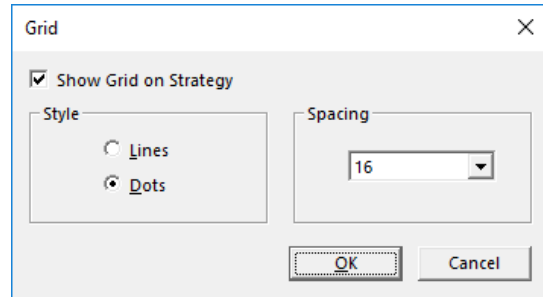

## MODIFYING DISPLAY COLOUR SETTINGS

From the **Strategy** tab on the **Ribbon**, choose **Grid Colour** or **Background Colour**.

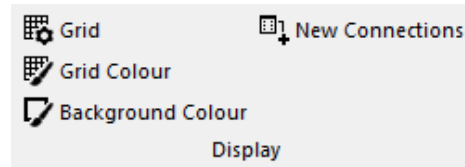

In both cases, the **Colour** dialog box is called. This allows you to select from a range of colours. You can also make custom colours, by clicking on the **Define Custom Colours** button. When you have selected the colour you require, click **OK**. The colour is applied immediately.

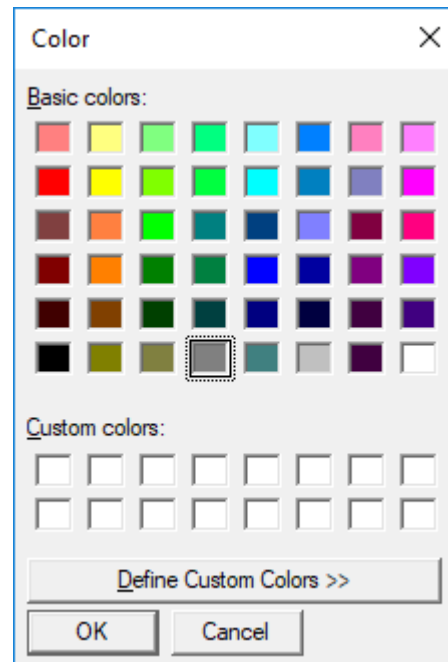

## SAVING FILES

CXpro<sup>HD</sup> allows you store files on disc by:

- Saving a new file
- Saving changes to an existing file
- Saving multiple files at once

Files will be saved in the "strat5" folder of the relevant site directory, under a numbered directory. The number of the directory matches the number of the BACnet Router to which the targeted controller is attached - for example:

C:\CXproHD\Lan\strat5\001\001\_01FanCoil.stg

would be a strategy in a controller on the first BACnet Router of the site called "LAN".

## SAVING A NEW FILE

If a file is being saved for the first time, press **[Ctrl]+[s]** on your keyboard or choose **Save** from the **File** drop-down.

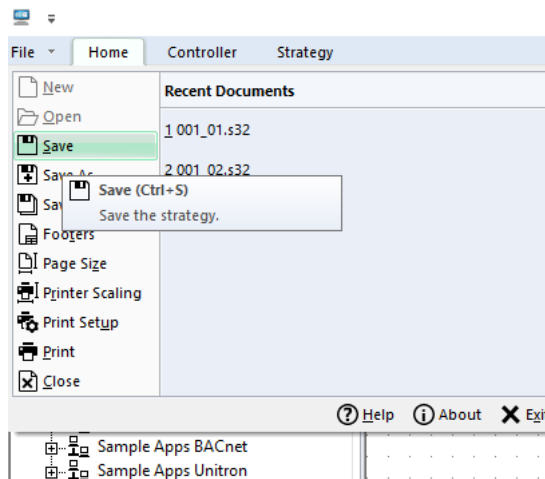

This produces the **Save As** dialog box allowing you to specify how the file is to be saved:

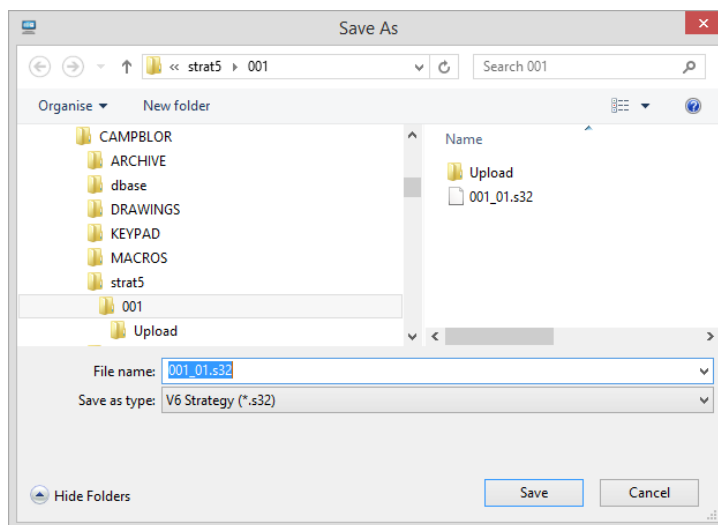

## SAVING CHANGES TO AN EXISTING FILE

If you have made changes to an existing file and wish to save those changes, but do not wish to rename the file, nor save it to a different location on the PC, you can save the file in two ways:

- Press **[Ctrl]+[s]** from the keyboard or
- choose **Save** from the **File** drop-down.

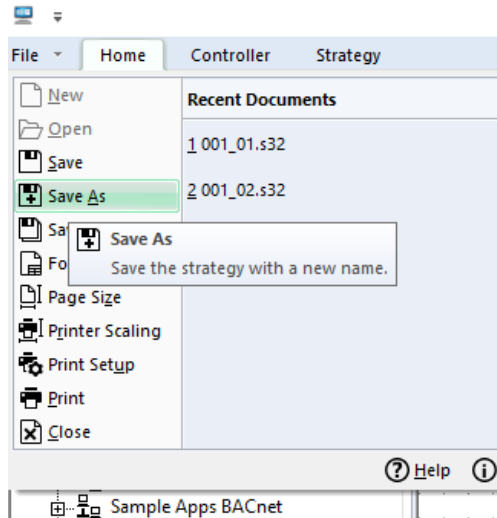

## SAVING MORE THAN ONE FILE

If you have a number of files open and wish to save them all, choose **Save All** from the **File** drop-down. This saves each of the files.

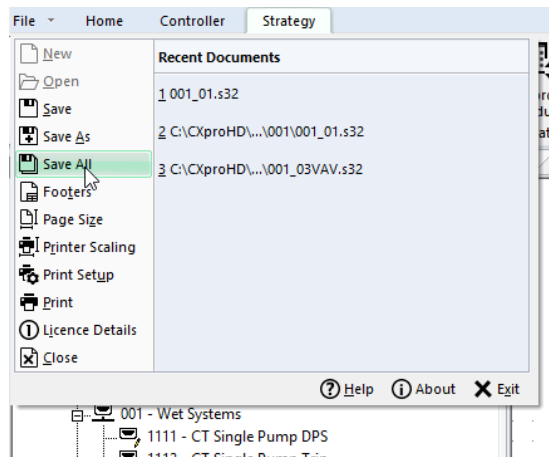

If one of the open files is being saved for the first time, CXpro<sup>HD</sup> will prompt you to specify a drive, directory, name, and file extension for that file by calling the **Save As** dialog box.



## PRINTING

CXpro<sup>HD</sup> can generate a hard-copy **printout** of the current strategy.

### INCLUDING A FOOTER IN A PRINTED STRATEGY

When you print files created in CXpro<sup>HD</sup>, they include additional information at the end of the printed page in the form of a footer. The footer includes the name of the site, as well as the BACnet Router and Field Controller for which the strategy is designed. You can edit the footer to include your name, your company's name, the name of the project to which the file belongs, the number of the drawing if any, and the date and details of any revisions made to the drawing.

How to edit the footer that will appear with the strategy when it is printed:

Choose **Footers** from the **File** tab of the **Ribbon**.

This opens the **Footers Details** dialog box:

**Footer Details**

Company Name: Cylon Controls Ltd.

Company Address: Clonshaugh Business and Technology Park.  
Clonshaugh  
Dublin 17  
D17 A662

**Project**

Project Title: Open-Plan Office      User: E. Peelo

File: 001\_01.s32      Project No.: 14

   Drawing No.: 5

**Revision**

Rev	Date	Drawing	Checked	Remarks
A	23/07/15	3	EP	Ok
B				
C				
D				

Save      Cancel

Enter the required details and click **Save**.

## ALTERING THE PRINT SET-UP

To define how the strategy is to be printed, choose **Print Setup** from the **File Tab of the Ribbon** to open the standard MSWindows **Print Setup** dialog box, where you can specify the required printer, paper, etc.

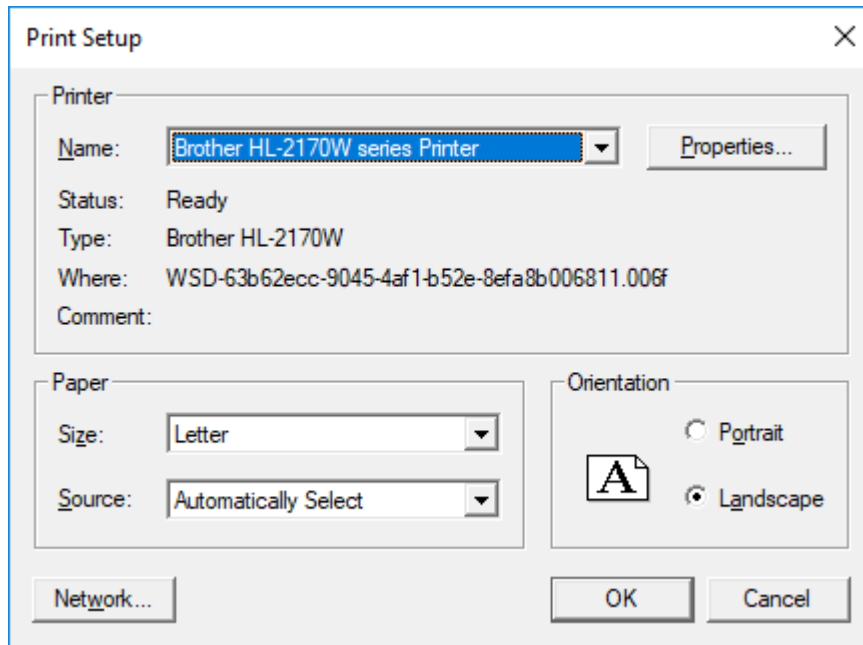

## PRINTING A FILE

To print a file, choose the **Print** option from the **File** tab of the **Ribbon**. This opens the standard MSWindows **Print** dialog box to specify the required printer, pages to be printed, and the number of copies.

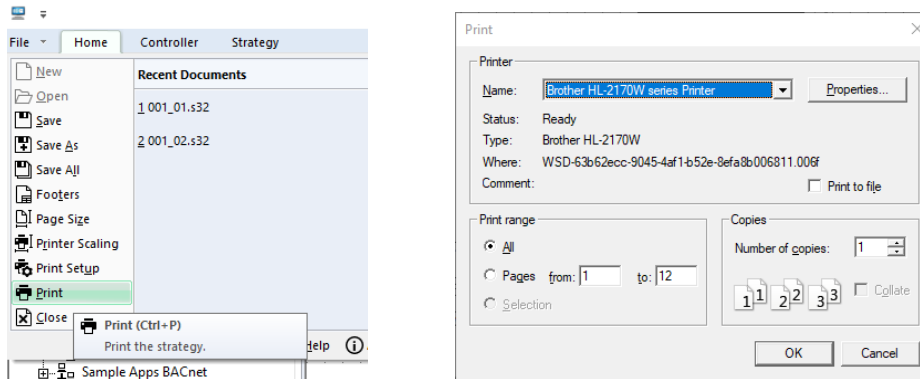

## CHANGING THE SIZE OF A PRINTOUT

If a strategy is large, it may not be possible to view enough modules on each page with a standard printout. CXpro<sup>HD</sup> has a **Printer Scaling** option, which allows you to decrease the printed size of the strategy so that more of it is visible per page.

Also, if you have set a strategy up for printing on a particular printer, you may find that if you try printing on a different printer it may not fit properly on the page. The **Printer Scaling** option allows you to adjust the printout size to compensate for this.

To resize a printout, select **Printer Scaling...** from the **File** menu

This opens the **Printer Scale** dialog box:

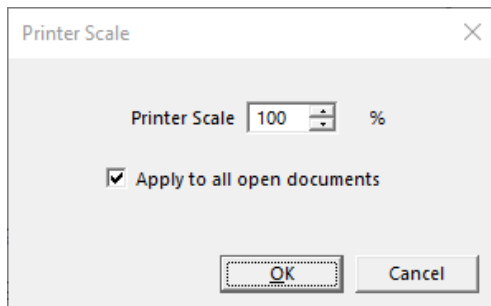

Enter a scaling factor between 20% and 300%.

- Factors from 20% to 99% will decrease the size of the modules in the printout.
- Factors from 101% to 300% will increase the size of the modules in the printout.

Ticking the **Apply to all open documents** box will set all currently-open strategies to print with the same scale.

## FITTING A STRATEGY TO A PAGE SIZE WHEN PRINTING.

The strategy drawing indicates where Modules will appear on the printed page, by drawing gray borders on the strategy drawing. In this example, the printer scaling is 100%

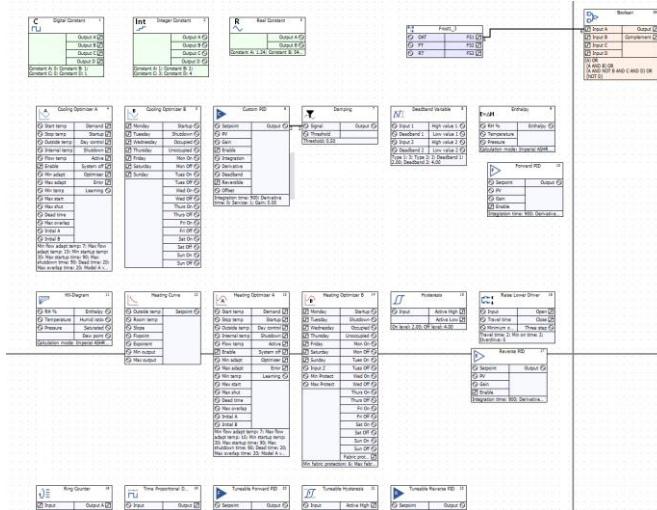

The Printer scale setting will change the size of the pages relative to the modules. Below shows an example of the printer scale of 200%

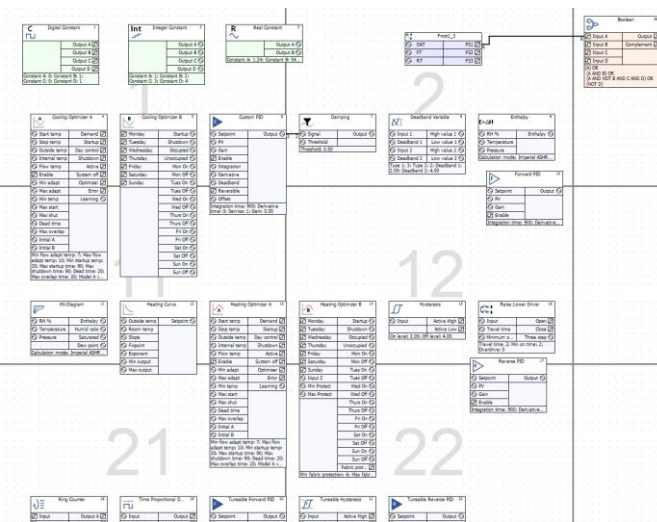

The physical page size represented by the gray borders is set by selecting **Page Size** from the **File** tab of the Ribbon. This opens the **Page Size** dialog:

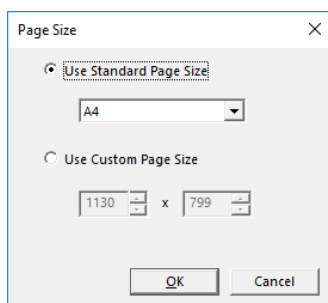

## CLOSING FILES

You can close an open strategy file in two ways:

Click the **Close** button at the top right-hand corner of the file window,

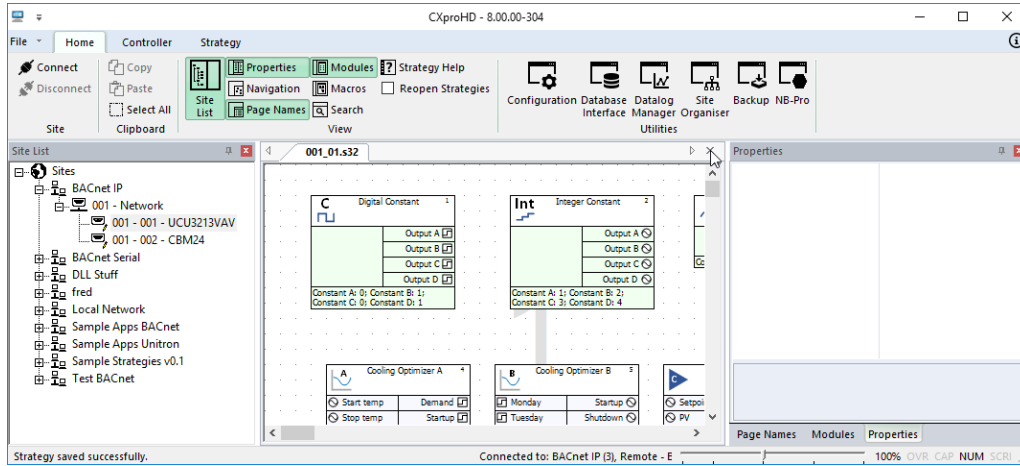

OR

Select **Close** from the **File** tab of the **Ribbon**.

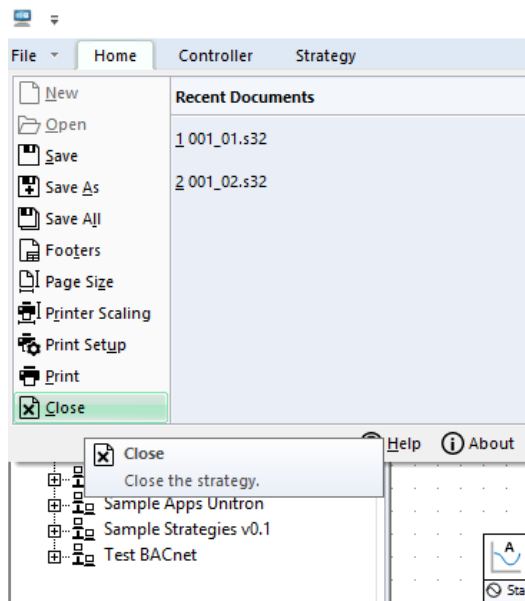

If changes have been made to the file since the last save, CXpro<sup>HD</sup> will prompt you to save it before closing.

If more than one file is open, selecting **Close** from the **FileTab** of the **Ribbon** closes the active window.

## 3 System Configuration

### SYSTEM CONFIGURATION DEFINITIONS

In order to properly communicate with and engineer **ABB Cylon**<sup>®</sup> BACnet Sites, the CXpro<sup>HD</sup> software installed on a PC must be given specific configuration information describing the sites to which the Software will connect, and the methods of connection to each of those sites.

What is meant by “System” during configuration?

The “System” is the current installation of CXpro<sup>HD</sup> software.

What is a “Site”?

A physical BMS Site in the **ABB Cylon**<sup>®</sup> system is either a single Field Controller acting on its own, or a collection of Field Controllers grouped into fieldbusses, co-ordinated by one or more Networks.

In CXpro<sup>HD</sup>, a “Site” is the virtual representation of such a physical BMS installation.

What is meant by “Network”?

There are 2 distinct types of channels through which CXpro<sup>HD</sup> can connect to a physical BMS installation:

- Serial Connection (RS232)
- BACnet IP

Each of these channels can be enabled or disabled, whether or not Sites have been configured to use them. Disabling channels can prevent delays when connecting to or disconnecting sites, by avoiding ‘auto detection’ being carried out through unused channels.

### CONFIGURING SITES

When you set up a Site, you need to provide the following information:

- The method that the supervisor PC will use to communicate with the Site
- The name of the Site
- The directory on the PC where the site information is stored
- The number and type of controllers on the site
- The controller names

## DEFINING THE CONTENTS OF A SITE

The CXpro<sup>HD</sup> system must be able to communicate directly with individual controllers within a Site. In order to do this, the software system must know how many controllers a Site contains and must be able to identify individual controllers.

The following information must be specified for each Site:

- The number of Networks on the Site
- The number of Field Controllers that are attached to each Network
- The names of the Field Controllers on the Site

This information is specified when adding a Site to the system by right-click on the root node of the **Site Tree** (i.e. the **Sites** node) and selecting **Add Site**

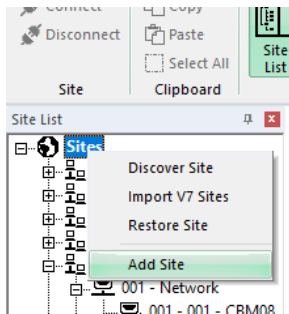

to open the **Add Site** dialog:

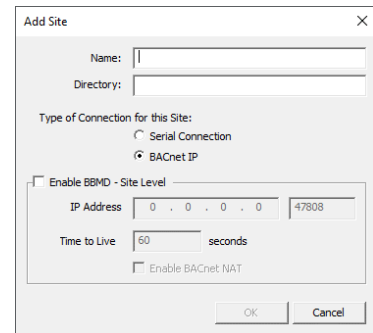

or when editing an existing Site by right-clicking on its node in the Site Tree and selecting **Properties**

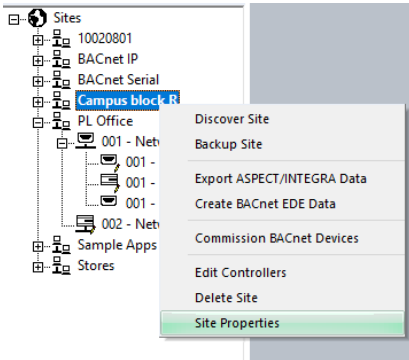

to open the **Site Properties** dialog:

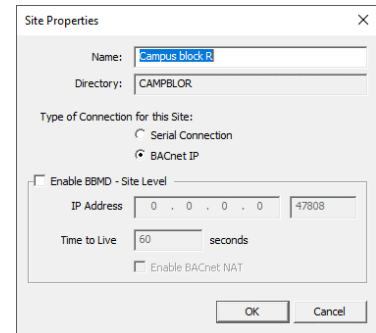

### Site Properties / Add Site Dialogs : Site Information section

Each site on the system is given a unique name to identify it to the user and CXpro<sup>HD</sup> programs.

❖ **Name**

The Site Name is used to identify the site at all places throughout the CXpro<sup>HD</sup> system. The Site name is entered in the Name field of the Add Site dialog box and can be edited in the Site Properties dialog when editing an existing Site.

The image shows a dialog box titled "Site Information". It contains two text input fields. The first field is labeled "Name" and contains the text "PL Office". The second field is labeled "Directory" and contains the text "PLOFFICE".

❖ **Directory**

You use the Directory field to specify the directory that will contain the site information.

The image shows a dialog box titled "Site Information". It contains two text input fields. The first field is labeled "Name" and contains the text "PL Office". The second field is labeled "Directory" and contains the text "PLOFFICE".

When adding a new Site, enter the name of the directory to contain the files for this Site. The name that you input here will be assigned to a subfolder of the CXpro<sup>HD</sup> directory that will be created to contain the site information.

- The software will suggest a directory name as you type the Site name in the Add Site dialog.
- The Directory name is limited to eighty characters.
- Giving two sites the same Directory name will cause the system to malfunction.
- The Directory cannot be edited in the Site Properties dialog when editing an existing Site.

### Site Properties / Add Site Dialogs: Selecting the Network for connection to a site (Type of Connection)

The image shows a dialog box titled "Type of Connection for this Site". It contains two radio button options. The first option is "Serial Connection" with an unselected radio button. The second option is "BACnet IP" with a selected radio button.

❖ **Serial Connection (RS232)**

If the Supervisor PC will connect to the Site by Serial communication (RS232), select Serial Connection

❖ **BACnet IP**

### Editing the number and names of controllers on a site

There are several reasons why you may wish to edit the information about the controllers on a particular site. For example:

- A new CXpro<sup>HD</sup> site has been set up
- A CXpro<sup>HD</sup> site connected to the PC has changed, (so the system information has to be changed to match)
- You want to change the description of a controller

CXpro<sup>HD</sup> programs must contain accurate information about the number and types of controllers that each site contains. This allows the supervisor PC to communicate accurately with the system sites.

You must specify the number and names of Networks on a site, and the number and names of Field Controllers attached to each Network.



To edit the controllers on a Site, right-click on the Site in the Site Tree and select Edit Controllers:

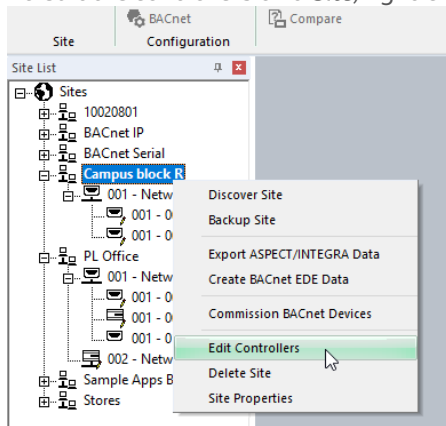

Which opens the Edit Controllers dialog, showing all of the Networks on the site.

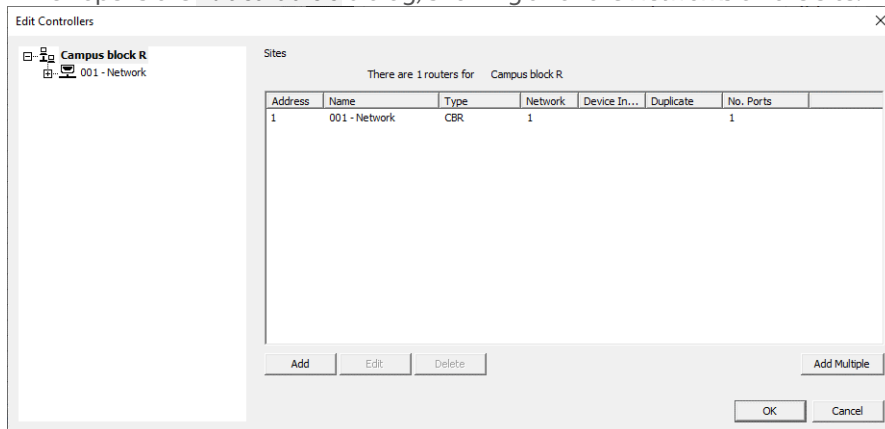

When a Network is selected in the Tree in the left-hand pane, the dialog displays the Controllers connected to the selected Network.

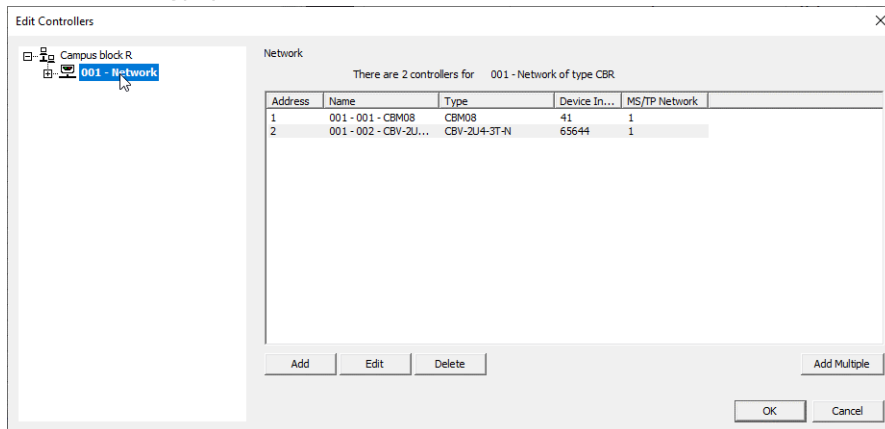

**Note:** You can also select a Network by opening the Edit Controllers dialog directly from that Network in the Site Tree:

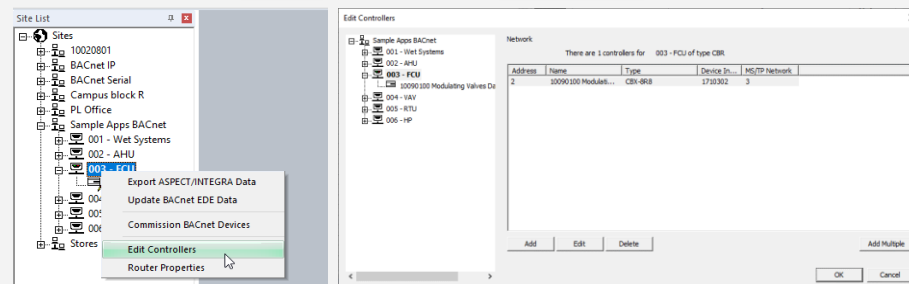

The **Edit Controllers** dialog box is used to specify the Network and Field Controller numbers and names.

By default, Networks are assigned sequentially numbered names in the format **001 - Network**, and Field Controllers are assigned names in the format **001 - 001 - CBM24**, with the Network or Field Controller number increasing in line with the number of controllers on the site.

The Field Controller name must be unique in the Site, so the Router address is included - e.g. on Router address 1, and Field Controller address 2 it can be either **001 - 002 - CBM24**, or **CBM24 - 002 - 001**.

The default names are automatically assigned but can be edited as necessary.

The dialog box allows you to specify the types of Networks and Field Controllers contained in the site, and the number of Field Controllers that are attached to each Network.

The left-hand pane of the dialog lists the Networks on the site. At the top of this pane, the Site Name and total number of Networks are displayed:

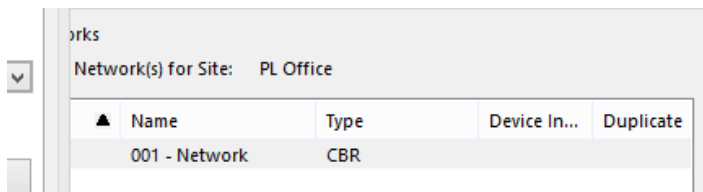

The right-hand pane of the dialog lists the Field Controllers connected to the Network that is currently selected in the left-hand pane. At the top of this pane the name of the selected controller and the total number of Field Controllers attached to the selected Network are displayed:

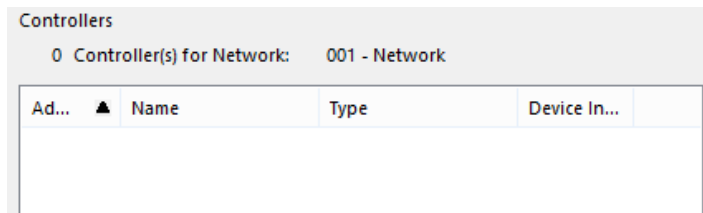

### ❖ Adding Networks to a Site

Before adding Field Controllers, one or more Networks (fieldbusses or Subnets) must be defined. The fieldbusses can be MS/TP or Modbus.

To add a new Network to the site, click the **Add** button underneath the **Network** list.

The **New Router** dialog will appear:

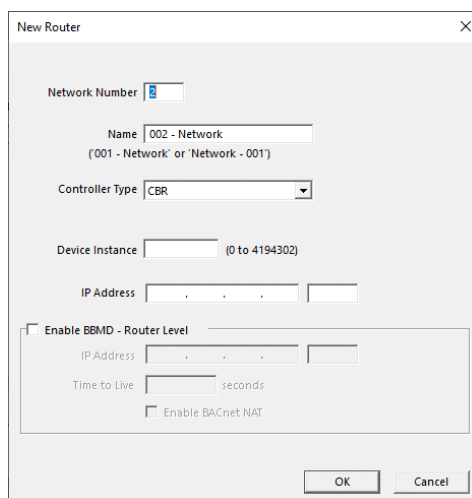

The next available Network Number is automatically assigned, but you can manually enter a different value in the **Network Number** field.

- Enter a name for the Network in the **Name** field.
- Select the Router type from the **Controller Type** drop down list.
- Enter a BACnet Device Instance Number.
- Optionally enter an **IP address** and **Port Number** for the Router.

**Note:** If the BACnet Device Instance Number is valid, then CXpro<sup>HD</sup> will read the IP address and automatically populate the Router IP address and HTTPS Port fields.

- If the Router is to be used as a BBMD, to transfer communications to a different BACnet network, check the **Use as BBMD** checkbox.

Click the **OK** button to confirm your choice.

**Note:** Additional tabs are displayed if a Modbus-enabled router is selected, to allow different **Address** and **Name** to be set for each fieldbus.

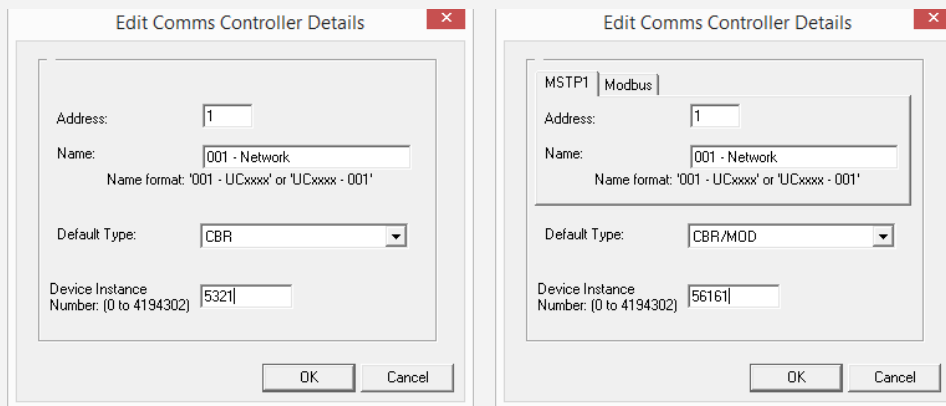

**Note:** If the router type is an extendable controller (FBXi, CBXi etc.), then additional fields are displayed in the **Edit Router** dialog that matches the Field Controller dialog described in *Editing Controller information* on page 36 and *FLX I/O modules* on page 36

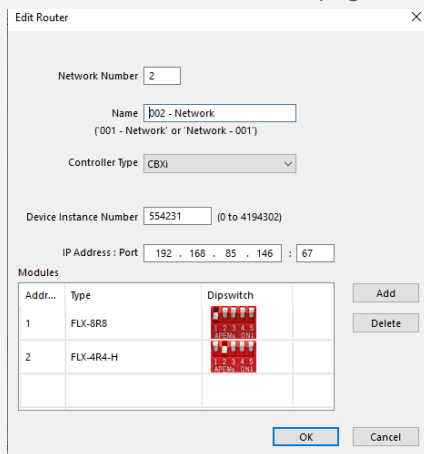

**Note:** If the router is set to a type that does not support routing BACnet traffic to MS/TP networks, the right-hand section of the **Edit Controllers** dialog will be disabled.



An I/O Modules table will become visible in the New Controller dialog:

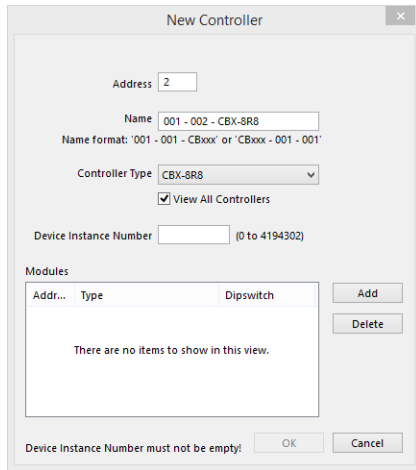

If the FBXi/CBXi/CBX device has one or more FLX modules connected to it, add the same number of entries in the I/O Modules table:

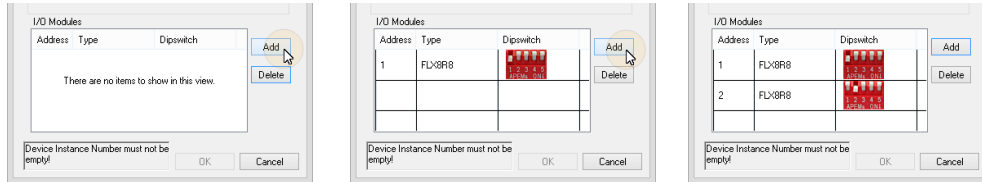

**Note:** On FBXi devices, the first FLX can be set to address 0. On CBXi and CBX devices, address 0 is reserved for onboard I/O

If you attempt to add more modules than the FBXi/CBXi/CBX can support, an error message will be displayed:

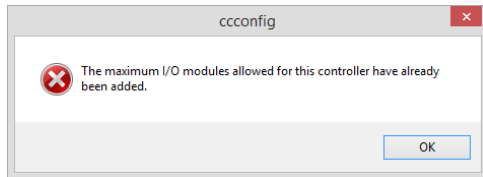

When the correct number of FLX modules have been configured, enter a Device Instance number and click OK.

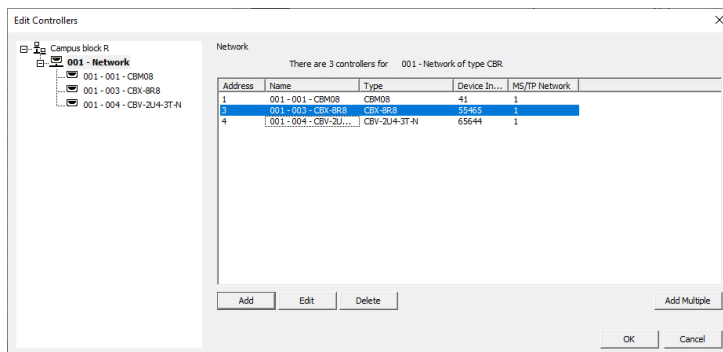

In the strategy drawing, IO blocks can be added up to the total on the configured FLX modules plus the CBX onboard IO.

**Note:** If a FLX module is deleted from a FBXi/CBXi/CBX configuration after the strategy drawing has been set up, the blocks associated with that FLX's IO will be 'greyed out' to indicate that they are inactive.

❖ **Modbus devices**

A **CBX** controller can communicate with up to 4 Modbus devices connected to its Modbus RTU port. IP Controllers (**CBXi**, **FBXi**, **FBVi** etc.) can communicate with

- Up to 247 devices per RTU port
- Up to 1280 devices via Modbus Router
- Up to 600 Modbus IP devices

These devices are configured in **CXpro<sup>HD</sup>** in a similar way to **FLX** modules.

To configure Modbus devices,

1. open the strategy of the **FBXi**, **CBX** or **CBXi** to which the Modbus devices are connected
2. in the **Site Tree** right-click on the **FBXi**, **CBX** or **CBXi**, and
3. select **Configure Modbus Devices** from the context menu

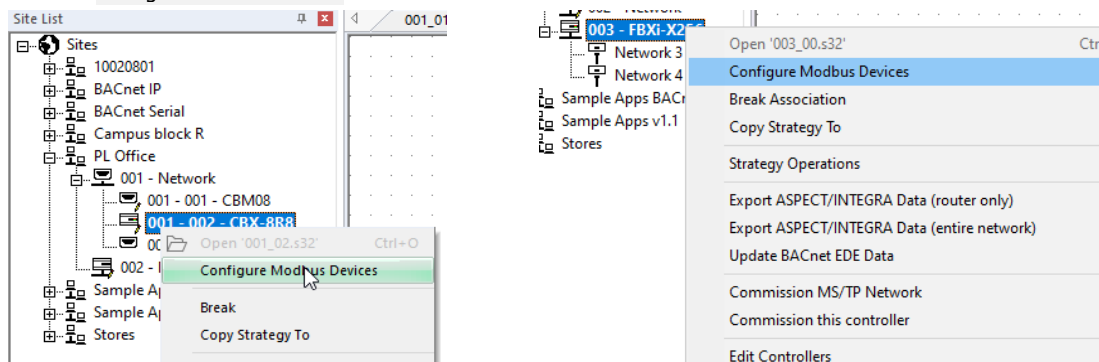

**Note:** The **Configure Modbus Devices** option will not be available unless the controller has an associated saved strategy that is currently open.

This will open a dialog that allows you to configure the **FBXi/CBXi/CBX**'s Modbus RTU port to match the attached devices and to add an **Address** and **Name** for each of those Modbus devices.

Configuring the **FBXi**, **CBX** or **CBXi**'s Modbus RTU port

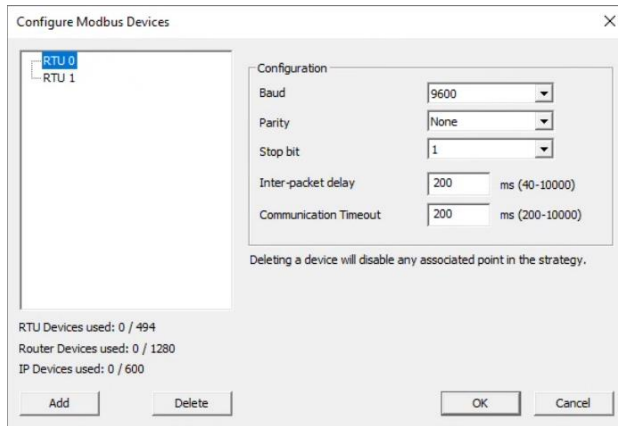

**Note:** When configuring Modbus on **FBXi** two separate RTU networks are available:

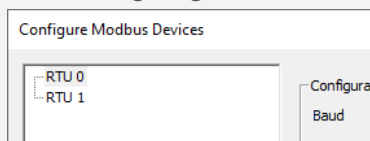

When the **RTU** node of the **Device Tree** is selected, you can specify the **Baud**, **Parity**, and **Stop bit** settings that all devices on the RTU network will use to communicate.

**Note:** With Modbus, all devices on an RTU network must be configured with the same communication parameters for the network to function properly.

Set an **Inter-packet delay** value that is reasonable for the devices on your network. Modbus devices commonly need time for the RS-485 transceivers to switch from a writing mode to a reading mode. Some Modbus devices will write to their flash or perform similar operation before being ready for the next Modbus command to be sent. Set the **Inter-packet delay** to a value that allows for the worst-case operation.

The **Communication Timeout** is the time the CBX will wait before giving up on one request and moving on to sending the next request.

**Note:** The status output of a Modbus Analog or Modbus Digital module will display a value that is non-zero for any failing Modbus transmission.

### Adding and Removing Modbus Devices

Before an FBXi, CBX or CBXi can access Modbus points, it must be configured with a list of Modbus devices that is available to the Modbus Analog or Modbus Digital modules.

To add a device, click the “Add” button

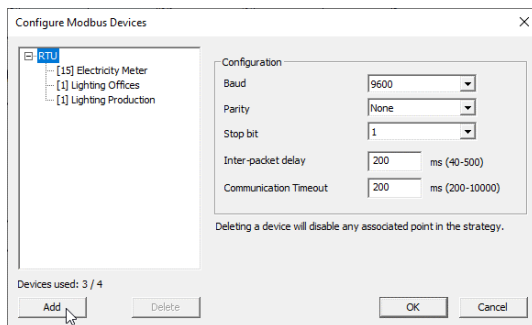

For CBX products, the device is automatically added the single RTU port.

For FBXi and CBXi products, you will be offered the choice of channel to which the Modbus device will be connected: RTU port, Modbus Router or IP port:

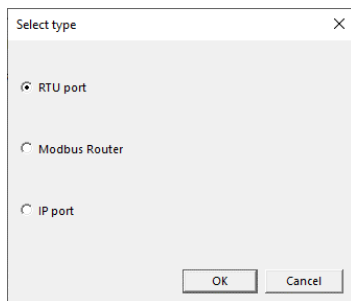

If you choose **RTU port** on an FBXi, you will be offered a further choice – RTU 0 or RTU 1

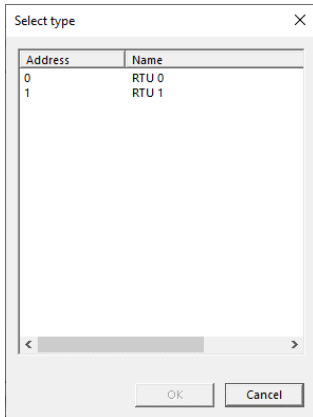

When the channel has been selected, a new device will be added to the tree. Select it:

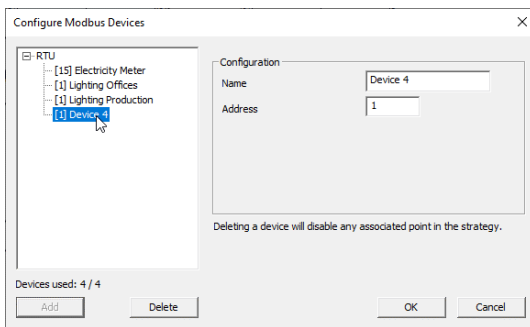

and then edit the **Name** and Modbus **Address** of the Modbus device.

The **Address** must be one of the following:

- **Modbus RTU** - A number between 1 and 255.
- **Modbus TCP** - An IP address with optional port, in the format `nnn . nnn . nnn . nnn : pppp`. The port (`pppp`) is separated by a semicolon. The port is optional, and if omitted the default Modbus port of 502 will be used.
- **Modbus RTU device behind a Modbus Router** - An IP address with an optional port and RTU address in the format `nnn . nnn . nnn . nnn : pppp / zzz`. The port (`pppp`) is separated by a semicolon. The RTU address for routing (`zzz`) is separated by a '/' character. The port is optional and if omitted, the default Modbus port of 502 will be used. For routing, the RTU address is required.

**Note:** The Modbus Addresses do not need to be sequential.

To delete a **Modbus** device from the list, choose the device, and click the “Delete” button.

At any time later, the **Address** of the Modbus device can be updated without any change to the **Modbus Analog** or **Modbus Digital** modules in your strategy.

### Accessing Modbus points in the Strategy

To access a point within any of the Modbus devices configured for a specific CBX, add a **Modbus Analog** module or **Modbus Digital** module (whichever is appropriate for the point) to that CBX's strategy.



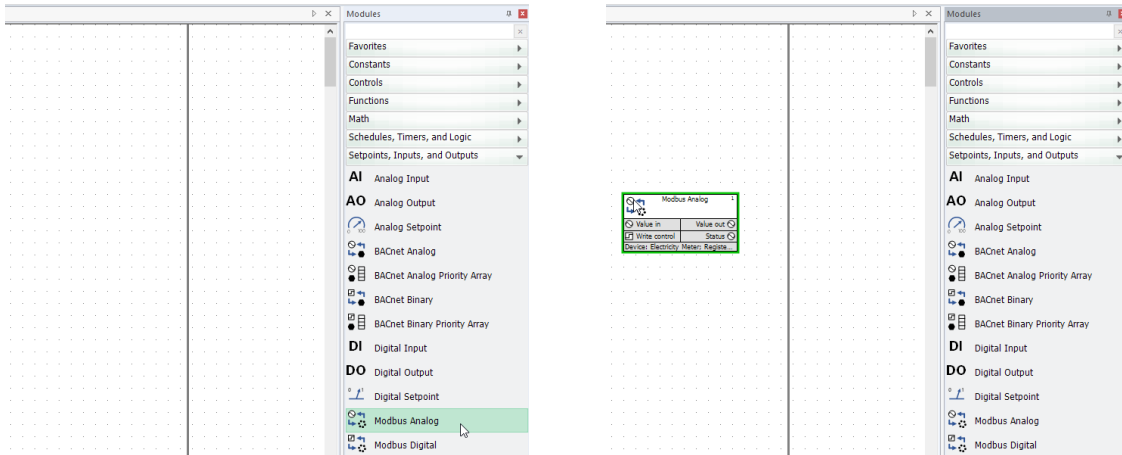

Modbus modules are displayed as follows:

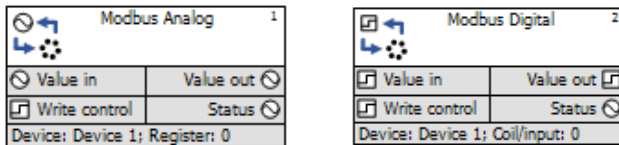

In the module **Properties**, specify which of the CBX's configured Modbus devices contains the required point:

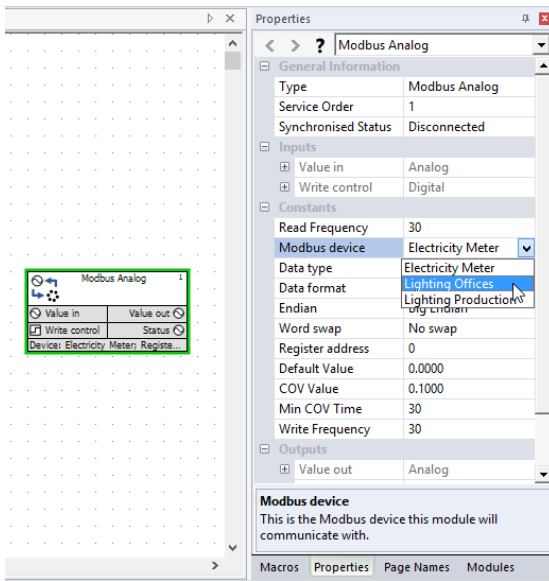

The modules are capable of interacting with the following Modbus entities:

Module	Action	Modbus Entity
Modbus Analog	Reading	Input Register
Modbus Analog	Reading and Writing	Holding Register
Modbus Digital	Reading	Discrete Input
Modbus Digital	Reading and Writing	Coil

For writing to occur, the “Value in” input of the module must be connected. For reading to occur, the “Value out” output of the module must be connected.

If **Write Control** is connected, then the input value must be a 1 before COV or other timers are evaluated.

Reading data from a Modbus device is done periodically and controlled by the “Read Frequency” constant.

Writing can be performed either periodically or be triggered by a change of value. For a Change Of Value, if the input value to the module changes (or, in the case of a **Modbus Analog** module, changes by a predetermined amount), then a write is performed.

The **Modbus Analog** module can handle endian differences, word swapping, and interpretation of the value read from the Modbus device.

## ❖ Removing a Controller from a Site

Clicking the relevant **Delete** button while a Network or Field Controller is selected, will remove the selected Controller from the list.

## ❖ Adding Multiple Controllers

At certain times you may find it convenient to add several controllers to the site at once.

The **Edit Controllers** dialog contains an **Add Multiple** button underneath each of the Network and Field Controller lists.

- If you click the button under the Network list, you can automatically add several Networks to the Site.
- If you click the button under the Field Controller list, you can add several Field Controllers to the currently selected Network.

When you click either of the two **Add Multiple** buttons, the relevant **Generate Default Names** dialog will appear.

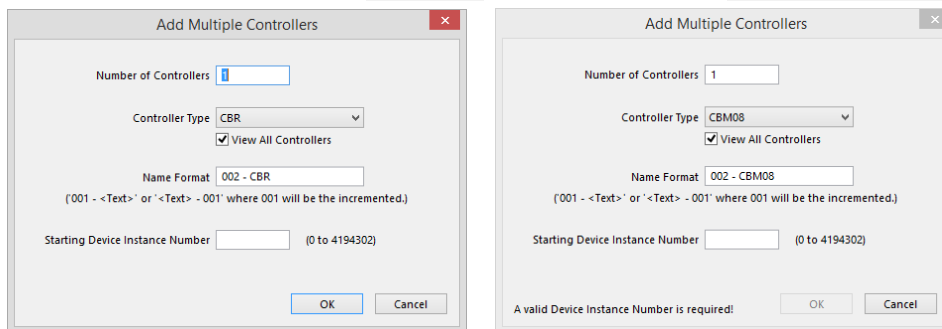

These dialogs are similar to the Add dialogs for single Comms and Field Controllers, with the exception that the **Address** parameter is replaced with a **Number of controllers** parameter.

This parameter specifies the maximum address that will be used to generate controller entries. What that means is that controller entries are generated starting at the next available controller address and continuing as far as the address specified in the **Number of controllers** box.

For example, if controllers exist for the current Network up to address 5, and the **Generate Default Names** facility is used with 10 in the **Number of controllers** box, then Controllers will be generated for addresses 6, 7, 8, 9 and 10.

**Note:** The **Number of controllers** parameter does **not** represent the total number of items that will be added automatically. Instead, it represents the maximum address that will be generated.

❖ **Sorting the Controller List**

The Network and Field Controller lists can be sorted based on:

- Address
- Name
- Type

By default, the controllers in the list are sorted by address. To sort by any of these columns, click the column header at the top of the controller list.

❖ **Saving the changes made in the Edit Controllers dialog**

When you click **OK** from the **Edit Controllers** dialog, the changes are immediately validated.

## CONFIGURING SERIAL PORT CONNECTION

In order to modify Serial Port settings, or to choose between serial ports if your PC has multiple ports, open the **Application Settings** dialog by clicking on the **Settings** icon in the **Settings** group of the **Home** ribbon:

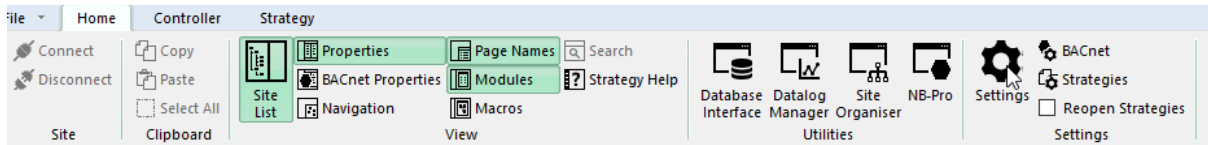

In the **Application Settings** dialog, select **Serial Port Connection**:

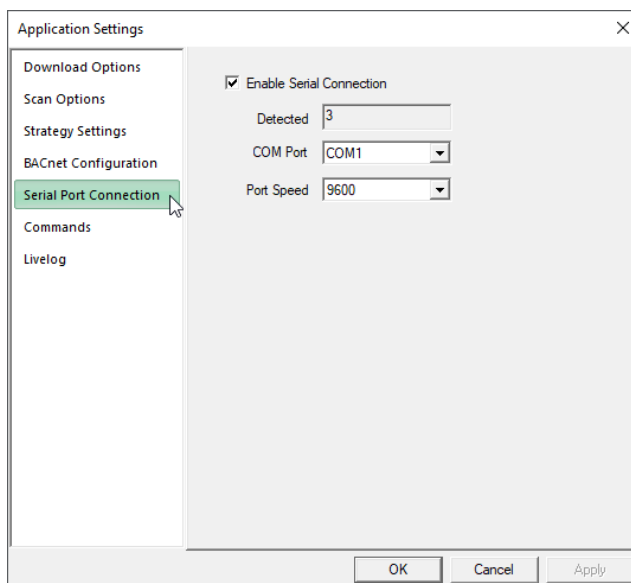

## CONFIGURING STRATEGY DEFAULTS

By selecting the **Strategy Settings** option in the **Application Settings** dialog, you can set several default values for new strategies:

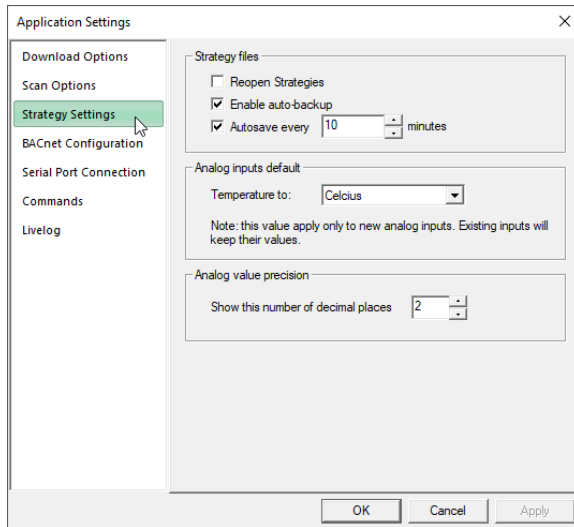

This can be opened directly by clicking on the **Strategies** icon in the **Settings** group of the **Home** ribbon:

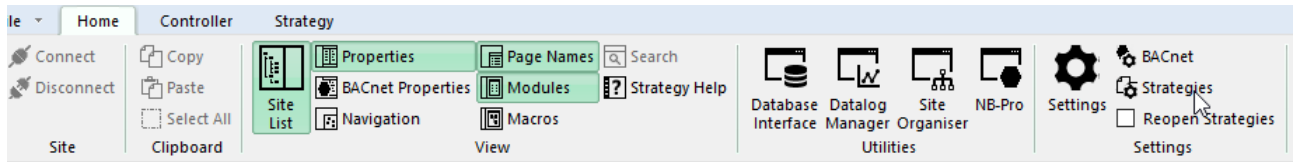

Also in the **Settings** group of the **Home** ribbon, there is a checkbox that defines whether or not strategies that were open when CXpro<sup>HD</sup> was closed will be automatically opened when CXpro<sup>HD</sup> next starts.

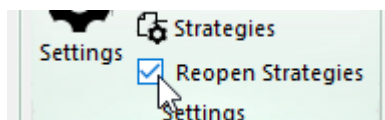

## CONFIGURING BACNET COMMUNICATIONS

In order to connect CXpro<sup>HD</sup> to a specific BACnet Site, you must set its system-wide BACnet Properties in the **Application Settings** dialog.

These properties are the identity of the Network Adapter that will be used to connect the PC to the BACnet System, and the Device Instance Number of that Network Adapter in the BACnet system.

Open the **BACnet Configuration** option in the **Application Settings** dialog by clicking on the **BACnet** icon in the **Settings** group of the **Home** ribbon:

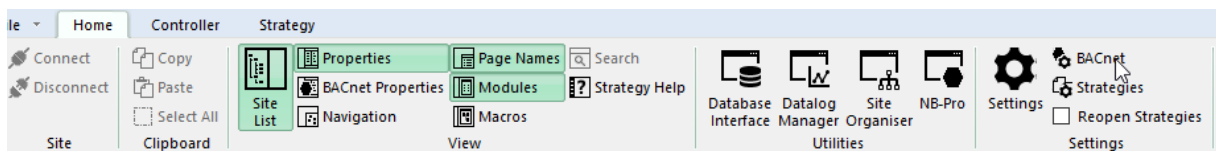

This opens the **Application Settings** dialog with **BACnet Configuration** selected

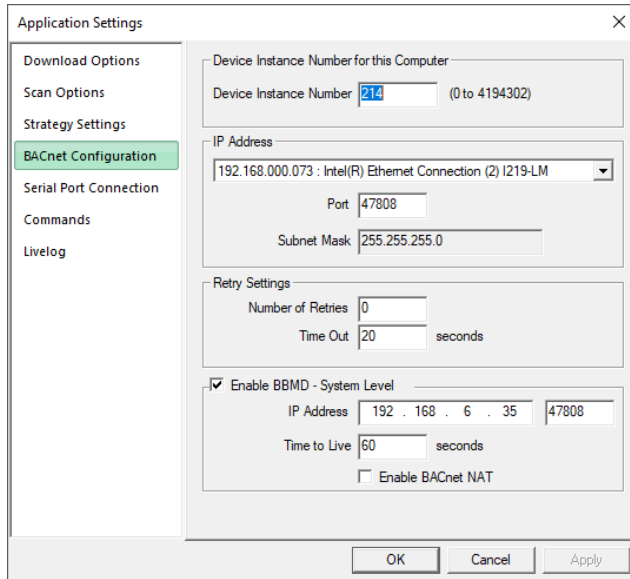

The **Device Instance Number** will be set to “-1”. This must be changed to a unique Device Instance Number.

In the **IP Address** drop-down list, select one of the PC’s network adapters to be used as the channel for all BACnet communication. Set the **Subnet mask** in accordance with the local network policy – if in doubt ask your local Network Administrator. The default is 255.255.255.0.

It is recommended that the **Number of Retries** is left at 0 unless there is a clear reason for changing it.

**Note:** In order to avoid conflicts with **Command** settings for set and get, the BACnet Timeout should be set to **Number of retries = 0** and **Time out = 20** seconds.

If you wish to connect to a remote BACnet site, enter that site’s IP address in the **BBMD settings – System Level** section.

Click **OK** to save these settings.

## CONFIGURING BBMD

If you wish to connect to a remote BACnet Site, you must set a Network, a Site or the CXpro<sup>HD</sup> system to act as a BBMD.

### What is BBMD?

Some BACnet services (e.g. “Who-Is”) use ‘broadcasts’. These broadcasts are blocked by standard Ethernet routers so that BACnet broadcasts are limited to the IP subnet of the BACnet device. A BACnet/IP Broadcast Management Device (BBMD) is one way to get around this limitation on a BACnet/IP network of 2 or more IP subnets.

### How a BBMD operates

A BBMD located on an IP subnet monitors broadcast messages on that subnet and constructs a “peer to peer” message for each broadcast to pass it through any IP router. This “peer to peer” message is received by other BBMDs on other IP subnets and transmitted as a broadcast on their attached subnets.

Since the BBMD messages are ‘directed’, individual messages must be sent to each BBMD. Each BBMD device maintains a Broadcast Distribution Table (BDT), the content of which is usually the same for all BBMDs within the network. Each BBMD must know the IP address of every other BBMD in the network.

### Setting a BBMD in CXpro<sup>HD</sup>

BBMD properties can be set at the System Level, on a Site or a Network, and if more than one is set then it ‘cascades’ upwards. This means that if a controller attempts to communicate with a remote BACnet Site, it will use the Network-level BBMD settings if any have been defined. If the Network to which the Controller is attached does not have BBMD settings configured for it, then the Controller will use Site-level BBMD settings if any have been defined. If the Site containing the Controller also does not have BBMD settings configured for it, then the Controller will use the System-level settings.

### BBMD Parameters

In the CXpro<sup>HD</sup> system, the following BBMD parameters can be set:

- IP Address
- Port Number
- Time to Live (not available in Site-level parameters)
- Enable NAT (Override “I am”) (not available in Site-level parameters)

**Note:** If a BACnet device must be accessed through VPN, and the VPN is not on the same network as the BMS, then a NAT rule can be used on the internal router connecting the two internal networks. This maps a port number on the Network1 IP Address to an IP Address + Port Number on Network 2. The IP Address and Port Number must correspond to that of the BBMD router.

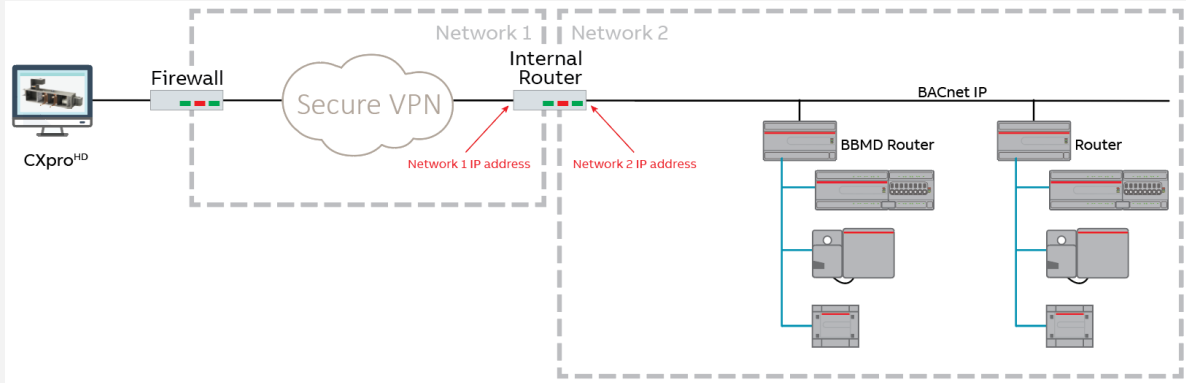

In the diagram above, the internal router is set up to map a port number on its Network 2 address to the internal BBMD router address. The CXpro<sup>HD</sup> BBMD settings are then set to the internal router's Network 1 address & port.

In this scenario Discovery and the I-am messages reach CXpro<sup>HD</sup>, but when CXpro<sup>HD</sup> reads a property for one of the discovered devices, it would by default use the source IP Address found by Discovery (a network 1 IP address) instead of the actual BBMD address.

The Enable NAT (Override "I am") checkbox on the BBMD settings in CXpro<sup>HD</sup> forces it to always use the BBMD address for all communications.

### ❖ System-level BBMD parameters

To set the BBMD parameters for the whole CXpro<sup>HD</sup> system, click on the BACnet icon in the Settings group within the Home ribbon:

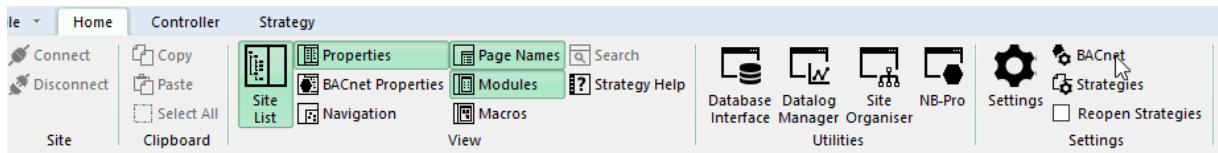

This opens the Application Settings dialog with BACnet Configuration selected. The BBMD - System Lev settings are at the bottom of the dialog:

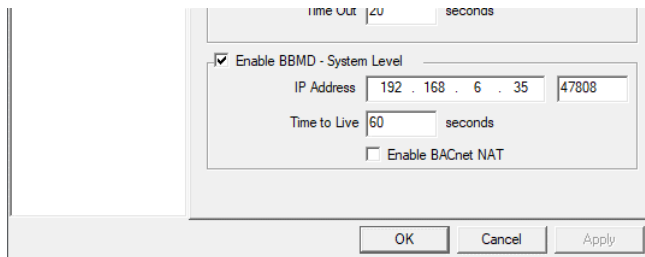

❖ **Site-level BBMD parameters**

To set the BBMD parameters for a specific Site, right-click on that Site and select **Site Properties**

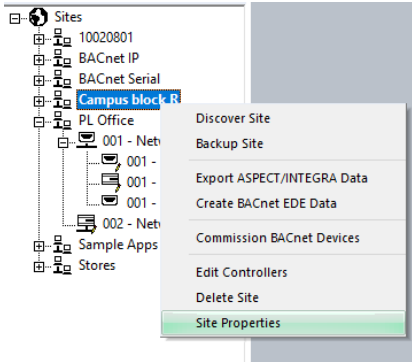

to open the **Site Properties** dialog:

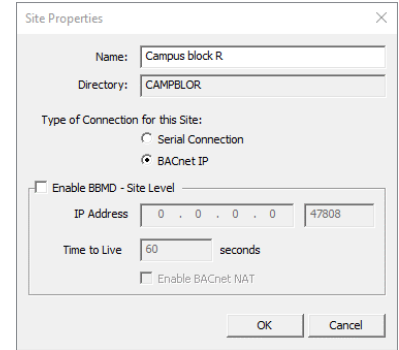

The Site BBMD settings parameters are at the bottom of the dialog.

❖ **Network-level BBMD parameters**

To set the BBMD parameters for a specific Network, right-click on that Network and select **Router Properties**

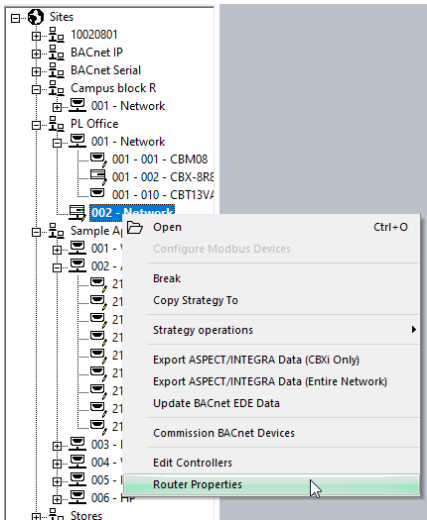

to open the **Edit Router** dialog:

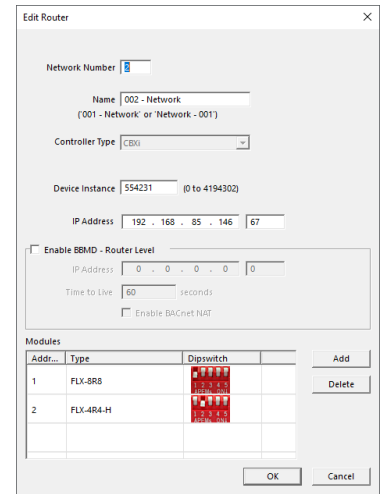

The IP settings in this dialog include a checkbox to allow the router to be used as a BBMD.



## CONFIGURING SITE COMMUNICATIONS (COMMANDS)

The commands that CXpro<sup>HD</sup> uses to communicate with **ABB Cylon**<sup>®</sup> controllers can be adjusted from the **Application Settings** dialog.

This can be useful in troubleshooting connection failures. It can be useful to tell the system to give the connection more time to become established.

On the other hand, if you have a reliable fast connection it can be of more benefit to reduce the time taken to establish connections, and so increase the speed and responsiveness of the system.

### Command Settings

To adjust the Commands settings, open the **Application Settings** dialog by clicking on the **Settings** icon in the **Settings** group of the **Home** ribbon:

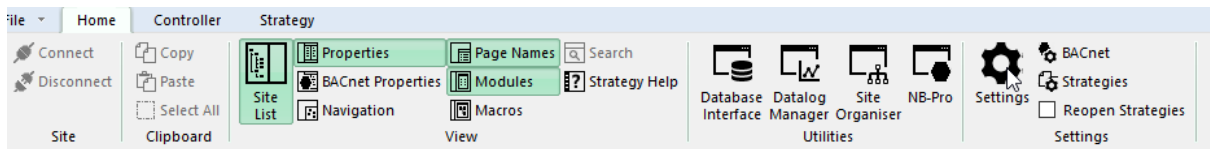

In the **Application Settings** dialog, select **Commands**:

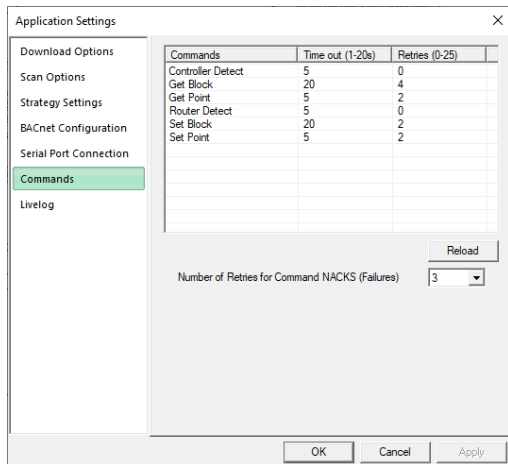

To edit a value, double-click on it in the Port Handler Command Settings dialog.

Clicking the **Reload** button will cause all of the values to revert to their previous settings, and any changes made will be lost.

Each command has a Retries setting:

- **Number of Retries for Command NACKS (failures)**

The retries in the main list apply to Timeouts, where no response is received. This parameter sets the number of retries when a response is received, and the response is NACK, indicating a failure.

When the **OK** button is pressed, each edited value is checked to see if it is valid.

If a command **Time Out** is greater than 20 seconds then it will be reduced to 20 seconds, and if a **Time Out** value is less than zero seconds, then zero seconds will be used.

If a command **Retries** value is greater than 25 then it will be set to 25, and if a **Retries** value is less than zero then it will be set to zero.

### Profiles:

The following profiles provide advisory settings that may be helpful when requests from a site and its controllers, or manipulation of data, results in failures.

❖ TCP/IP Profile:

Command	Time Out	Retry
Get Point	2000	1
Set Point	2000	1
Get Block	2000	1
Set Block	5000	1
Router Detect	2000	0
Controller detect	2000	0

❖ Default Profile:

Command	Time Out	Retry
Get Point	2000	0
Set Point	2000	0
Get Block	2000	0
Set Block	5000	0
Router Detect	10000	0
Controller detect	10000	0

## 4 Using Modules

### MODULES - OVERVIEW

**Modules** are the building blocks from which strategies are constructed. They are the basic units of operation in CXpro<sup>HD</sup>.

Modules perform tasks within a strategy such as

- bringing controller inputs into the strategy
- changing the values of points in the strategy according to mathematical rules
- comparing the values of points in the strategy
- recording the values of points in the strategy
- sending point values to the controller's outputs.

Modules can be grouped and saved as in order to avoid repetitive tasks, i.e. if you use a particular strategy or part of a strategy frequently, you can save it as a macro and reuse it without having to repeatedly re-create it.

### ACCESSING MODULES

By default, Modules are available from the right-hand pane, by clicking the **Modules** tab at the bottom of the Pane:

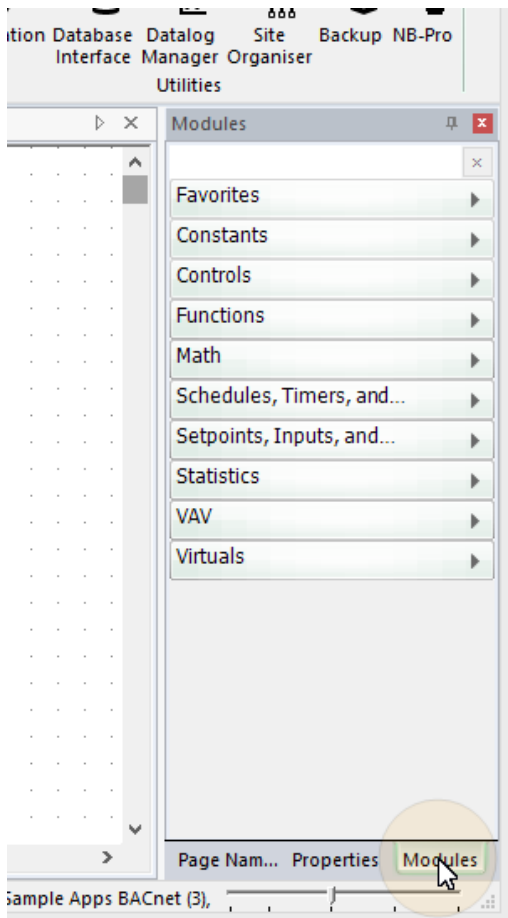

The Modules Pane groups the available modules into Constants, Controls, Functions, Math, Schedules/Timers, Setpoints/I/O, Statistics, VAV, and Virtuals. To access individual modules, click on one of the groups:

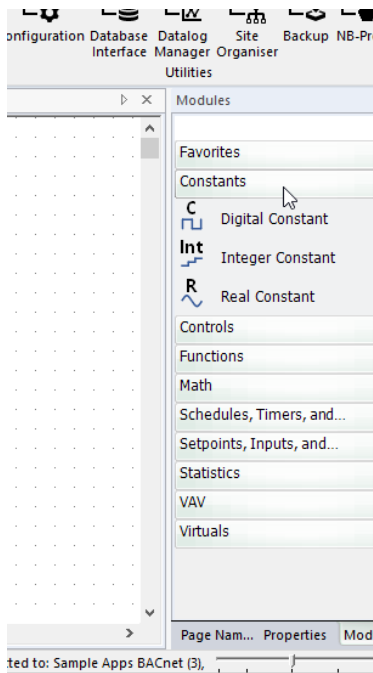

There is also a “Favourites” group, where you can set up a custom list of modules that you use frequently or want to be able to access quickly.

To add a module to the Favourites group, right-click on the module in the Modules Pane and select Pin to favorites:

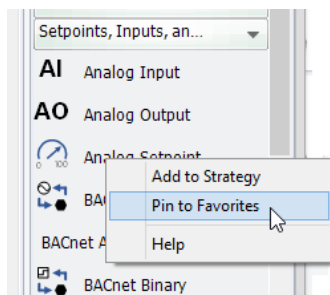

To remove a module from the Favourites Group, right-click on it and select Unpin from Favourites:

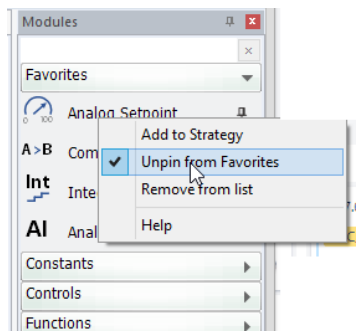

## PLACING A MODULE ON THE DRAWING AREA

In order to use a module in a strategy, you must place it in the strategy's 'drawing area'.

To do this, click on the module name in the **Modules** pane:

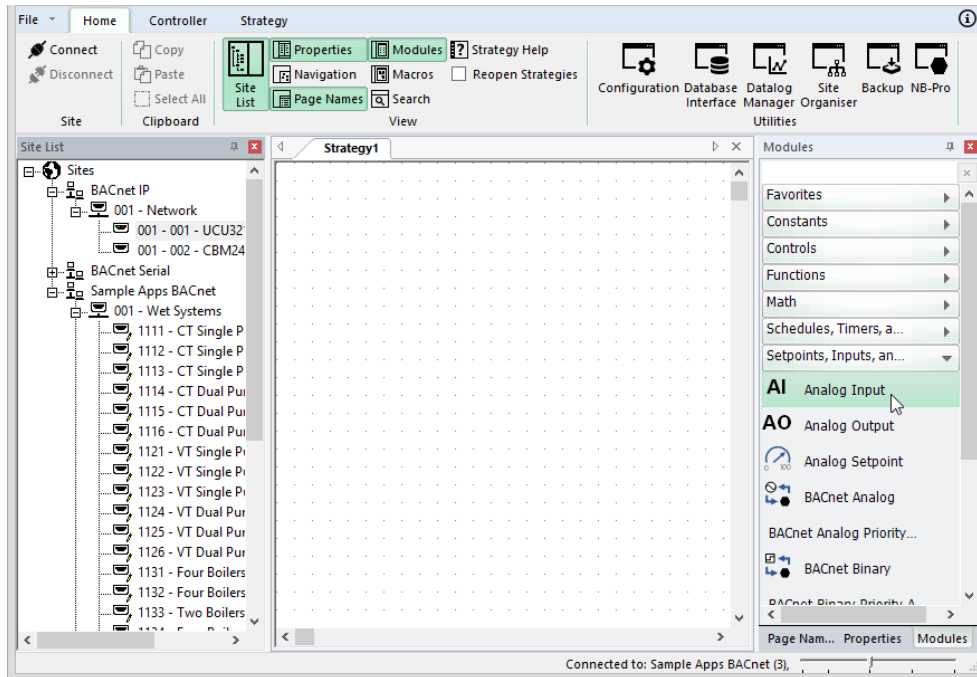

Then click on the strategy drawing area at the position where the module is to be placed (note the cursor changes to the "Module Cursor"  during this process):

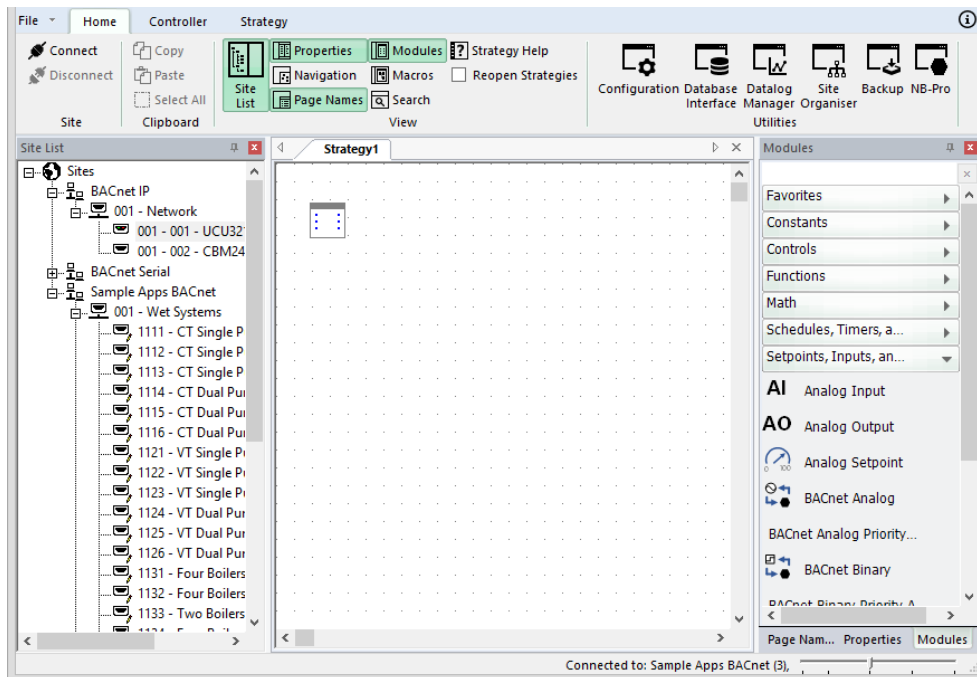

Some modules (e.g. Analog Input) prompt for basic configuration information when they are first placed. When this happens, fill in the dialog and click OK

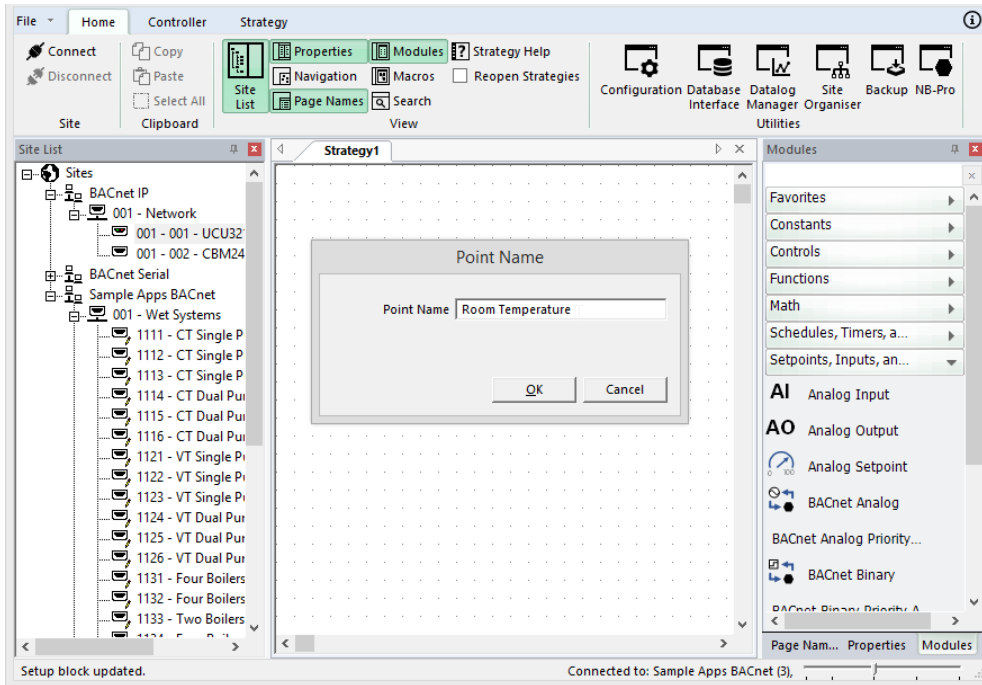

The module is displayed on the strategy drawing, and as it has just been placed it is automatically selected. This is indicated by a green outline:

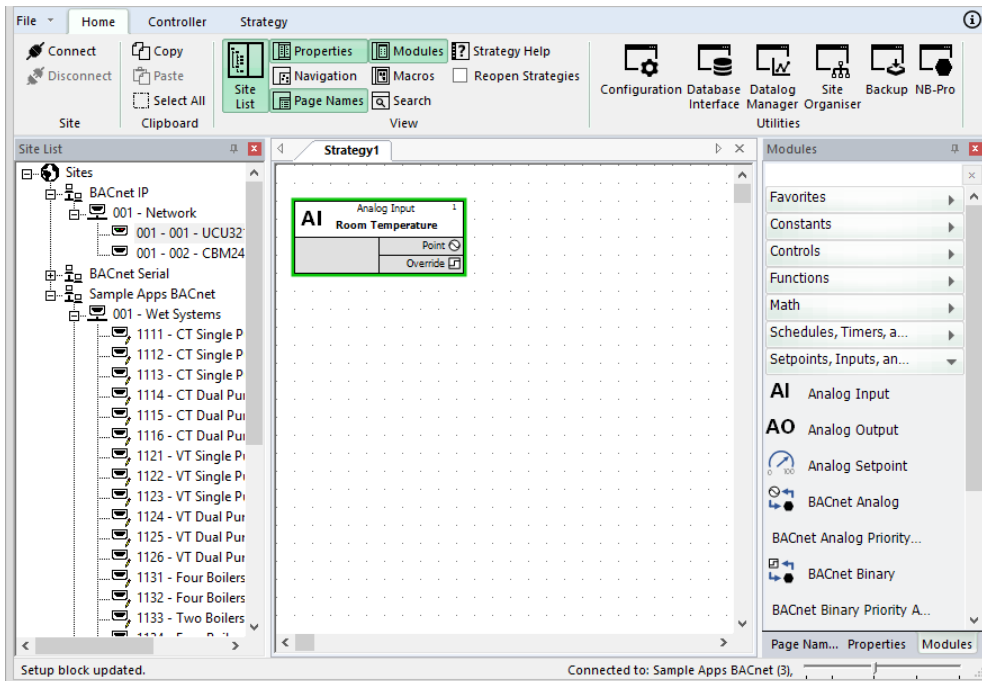

It is possible to examine and edit the properties of the selected module by clicking on the Properties tab at the bottom of the Right-Hand pane:

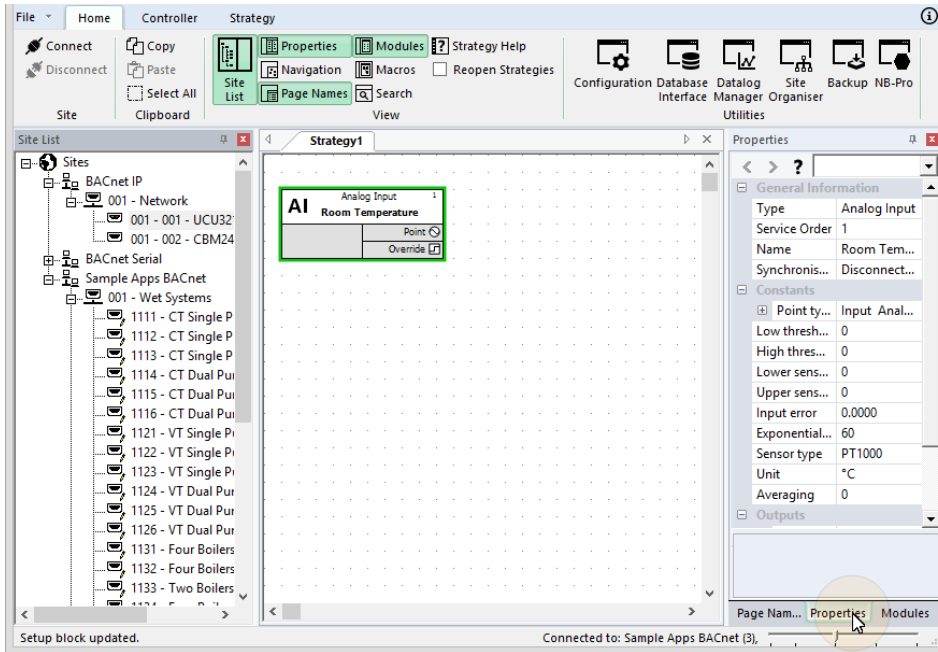

You can edit the properties of the selected module by clicking in the property's value in the right-hand pane. Help text relevant to the property being edited is displayed in the lower portion of the Right-Hand pane

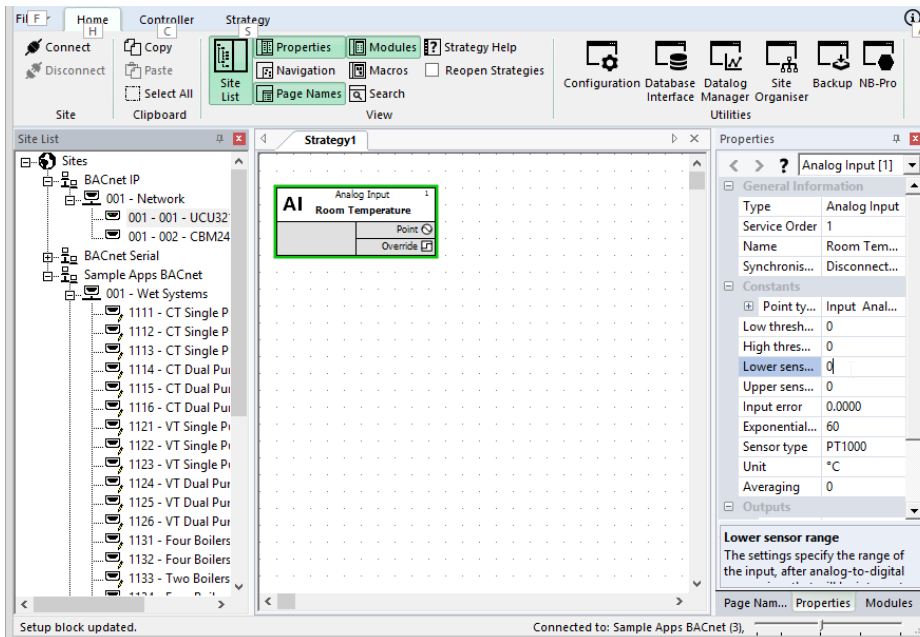

**Note:** If you have multiple strategies open at once, ensure that you select the strategy into which you would like to place the module before you select the module from the modules bar.

The module can now be **selected**, and **edited**, **moved**, **copied**, **cut**, or **joined** to other modules.

## SELECTING MODULES ON THE DRAWING AREA

Before you can move, copy, cut, or delete a module, you must first select it. This can be done by:

Clicking on the module symbol,

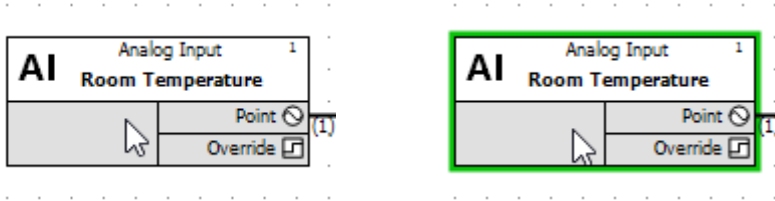

Or by clicking and dragging from the top left to the bottom right of the module symbol(s) as shown. When you release the mouse button, the module will be selected

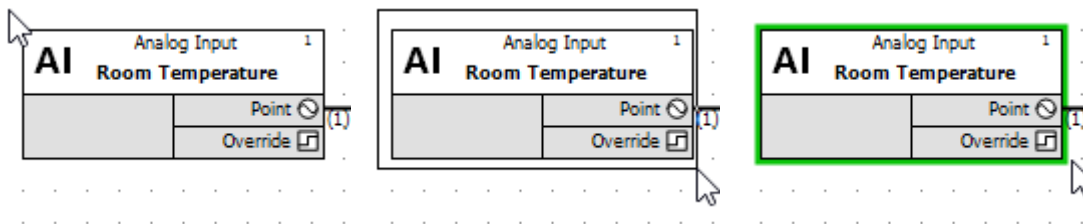

To select more than one module on the drawing area:

You can select multiple modules at once by the following methods:

4. Press and hold down the [Ctrl] button while clicking the modules required.
5. if you want to select every item in the drawing simultaneously, click on **Select All** in the **Strategy** tab.

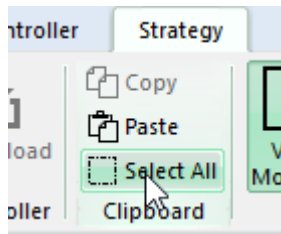

6. Click and drag a box around all the modules you want to select. When you release the mouse button, all the modules within the box will have been selected.

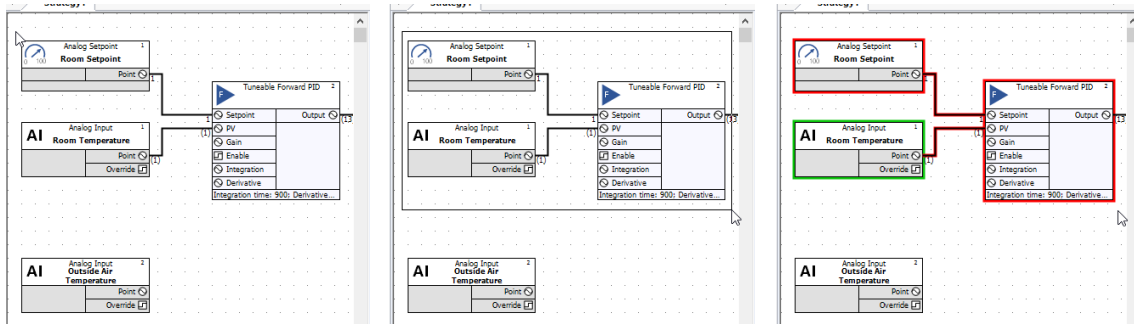

Selected modules (and points, which are represented by lines) are surrounded by coloured borders. Most modules will have a red border, but one will be green. This is the module (or point/line) whose properties are currently displayed in the Properties Pane – i.e. the module that is “in focus”.



You can change which of the selected modules is “in focus” by using the navigation controls at the top of the Properties pane, with the arrows:

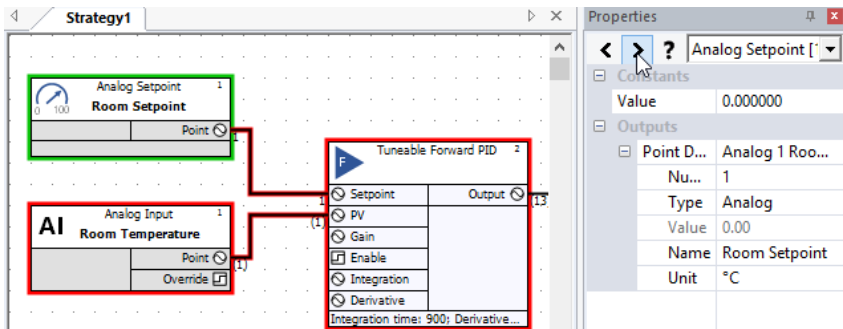

Or the drop-down, which lists the currently selected modules and points:

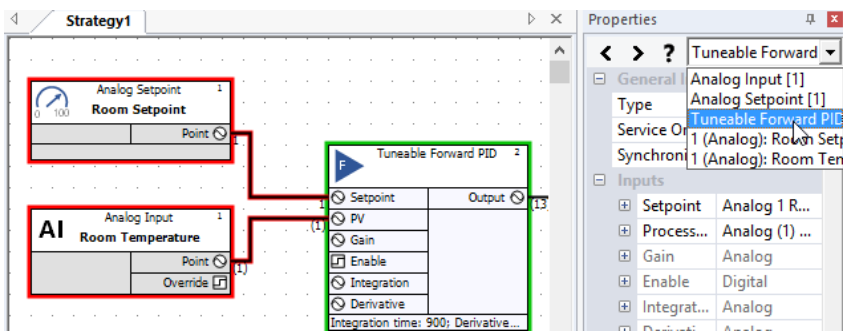

## MOVE, DELETE, CUT OR COPY A MODULE OR MODULES ON THE STRATEGY DRAWING AREA

In order to Move, Delete, Cut, or Copy a module or modules, you must first select the module(s) as described above. Then:

### Moving modules

To **move** the selected module(s) on the drawing area, drag any one of the selected modules. The modules and their connected points (lines) will move together. Alternatively, you can also use the arrow keys on the PC’s keyboard to move all of the selected modules at the same time.

### Deleting modules

To **delete** the selected module(s) from the drawing area press the **[Delete]** button on the PC’s keyboard.

### Copying modules on the drawing area

To **copy** the selected module(s) to the PC’s clipboard, so that they can be pasted to another part of the drawing area or to a different strategy, either

- Press **[Ctrl]+[c]** on the PC’s keyboard, or
- Click on **Copy** in the **Home** tab:

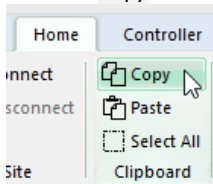

A copy of the module(s) will be saved on the Clipboard until placed (pasted) elsewhere.

Then, **paste** the module(s) to a specific point within the same strategy, or to another strategy, by first either

- pressing **[Ctrl]+[v]** on the PC's keyboard, or
- clicking on Paste in the Home tab:

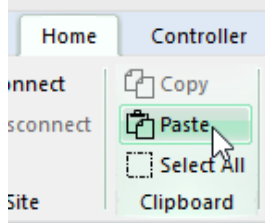

then click on the drawing area in the target strategy with the mouse. The top left-hand corner of the module(s) will be positioned on the point where the mouse was clicked.

**Note:** Pasted hardware point modules may adapt some parameters to the destination point but retain others. For example, an analog input configured as PT1000 when pasted to a UniPut will change to a voltage input but retain the max and min limits (in the **Advanced** button) which for PT1000 could be min 0 and max 0, leading to incorrect operation of the UniPut.

## TOOL TIP DATA ON MODULES

To view details of a specific Module, hover the mouse pointer over the Block in the strategy drawing.

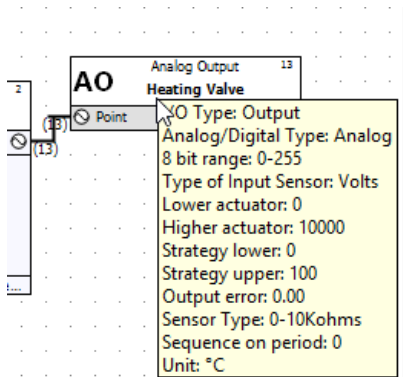

## JOINING MODULES IN A STRATEGY

Modules in a strategy must be **joined** together to allow information to flow from input to output. The flow is from left to right, so that controller input **connection points** are on the left of the drawing area, controller outputs are on the right, and the modules are positioned between the inputs and outputs in the center of the drawing area.

### Notes on joining modules

- A connection is possible only if both the input and the output are of the same type (analog or digital).
- An output of a module can be linked as often as required with inputs of other modules.
- An input of a module can be linked with only one output of a module.

## MODULE CONNECTION POINTS

Connection points are marked on module symbols as blue circles or squares on the left and right edges of the module. When the mouse pointer is placed over a connection point, it changes to a cross-hair.

- Circular connection points are analog.
- Square connection points are digital.

If you want to connect two points, make sure they are both either digital **or** analog. You cannot connect analog to digital or vice versa.

## HOW TO JOIN MODULES

Place the mouse pointer over the required output of the first module so that it changes to a crosshair.

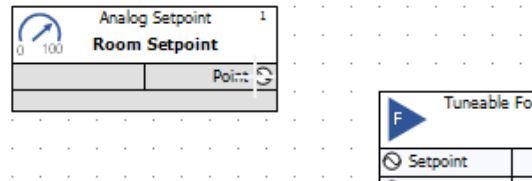

Click and drag the mouse from the output to the required input of the other module. You will see that the crosshair changes back to a mouse pointer once you have left the blue connection point and return to cross-hair format when you reach the next blue connection point.

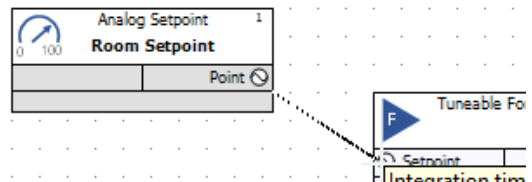

Release the mouse when you have reached the required input. The two modules are now joined. The connection between the two modules is marked by a coloured line. The default colour is black, but this can be customized by clicking on the connection line with the right mouse button.

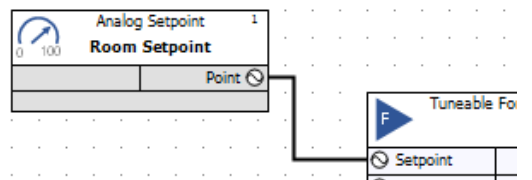

## HOW CONNECTIONS ARE REPRESENTED

By default, the connection between 2 modules is represented by a black line with the numbers of the points at each end of the connection also displayed (as in the above example).

You can customize the way in which all connections are represented by right-clicking on the Drawing Area to open the Display Options menu:

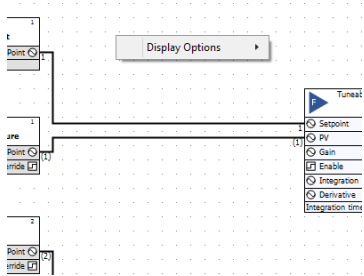

This gives access to the following options:

### Hide All Lines

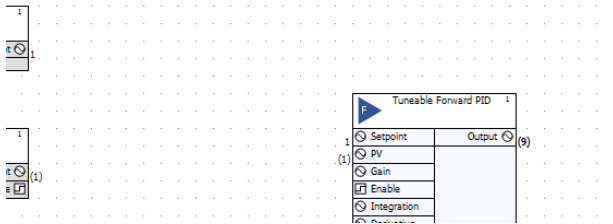
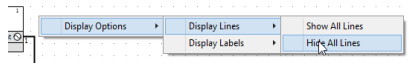

### Show All Lines

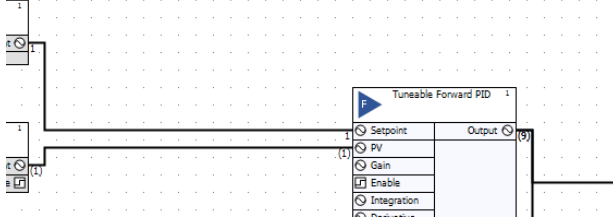
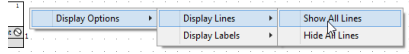

### Hide Labels

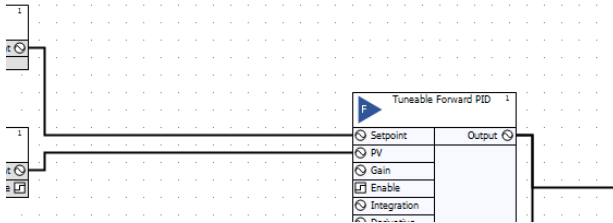
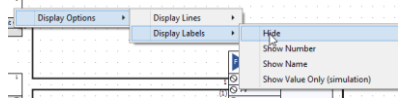

### Show Number

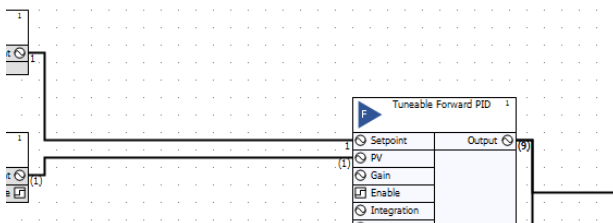
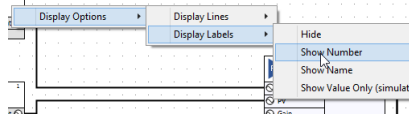

Show Name

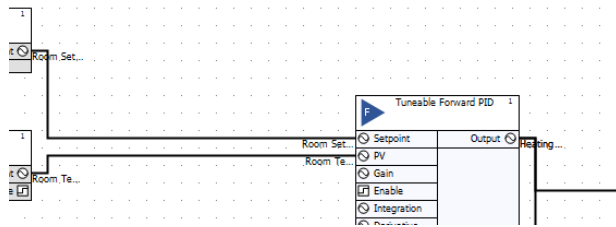
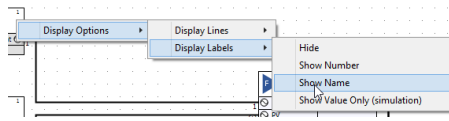

Show Value Only (Simulation)

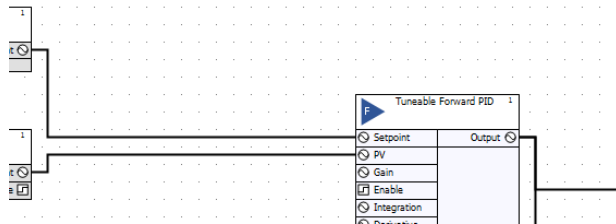
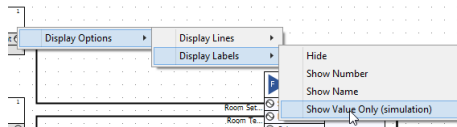

You can customize the line and label visibility of a single point (line) in the properties panel:

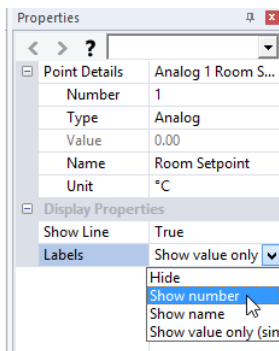

You can also change the default visibility using the New Connections option on the Strategy tab of the Ribbon:

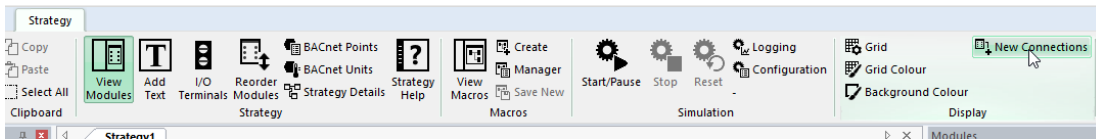

This opens the New Connections dialog, where you can set the appearance of new module connections:

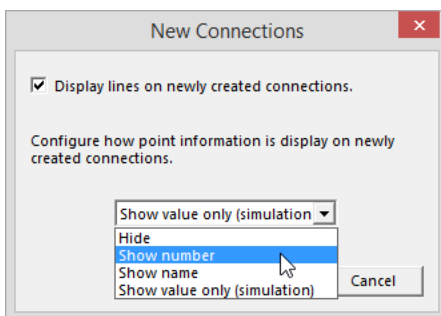

## CONNECTORS

Lines are a convenient and intuitive way to connect modules that are close together in the strategy drawing. However, clicking and dragging to connect modules that are far apart in the drawing can be impractical. To overcome this, CXpro<sup>HD</sup> provides an alternative way to connect modules using named Connectors.

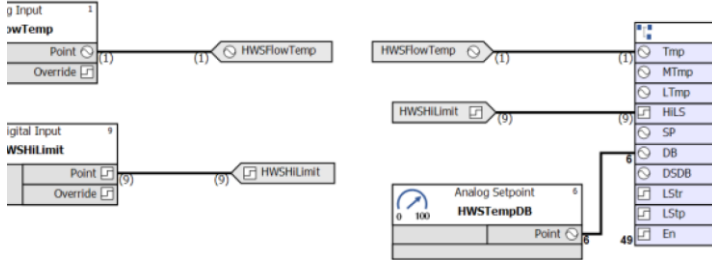

A **Connector** creates an invisible channel of information between a single Source and multiple Destinations.

### Add a Source Connector

To set up a Source Connector, right-click on any output on any module and select **Add Source Connector**.

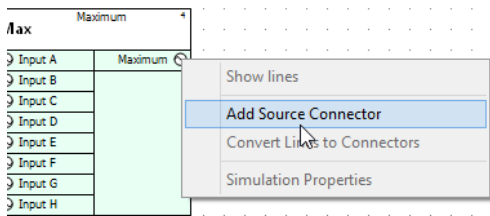

In the dialog that opens, enter a name for the point that will be exposed by the Source Connector you are creating.

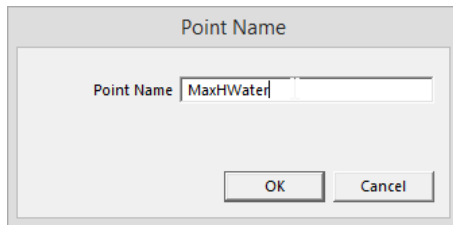

The Source Connector is now created.

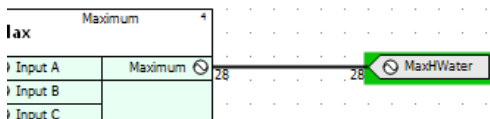

**Note:** Points exposed by Source Connectors **must** be named.

## Adding a Destination Connector

To connect a module to a point exposed by a Source Connector you must create a Destination Connector as follows: Right-click on any input of any module and select **Add Destination Connector**.

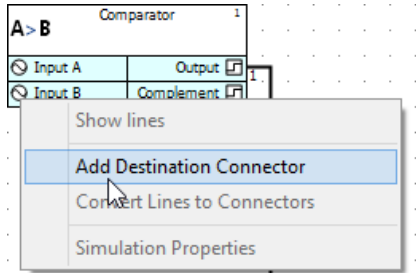

A list of Source Connectors will be displayed.

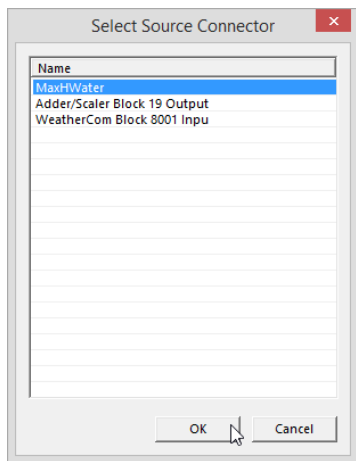

Choose the appropriate Source Connector and click **OK** to complete the connection. The new destination connector is added to the input of the module.

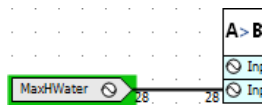

## Deleting Connectors

The rules for deleting connectors are as follows:

**Source:** If a Source Connector is deleted, **all** Destination Connectors connected to the Source Connector will also be deleted.

**Destination:** If a Destination Connector is deleted, it is the same as disconnecting an input from any output.

If the Destination Connector is the last one connected to the source, a dialog will be displayed asking the user if they want to delete the source. If they decide to do so, then the Source Connector will also be deleted. If the user does not delete the Source Connector, that point will be available for new Destination Connectors.

## Quick Searching for Connectors

### Jumping from a Destination Connector

Right-click on the Destination Connector and choose either **Jump to Source** or **Jump To Other Destination**.

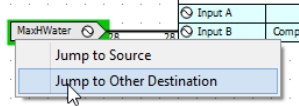

If you choose **Jump to Source** you will immediately be taken to that Connector.

If you choose **Jump To Other Destination** and there is only one available, you will immediately be taken to that Connector.

If you choose **Jump To Other Destination** and there is more than one available Destination, then the **Search Results** window (below the Strategy Drawing window) will display them as a list so that you can select which one to view.

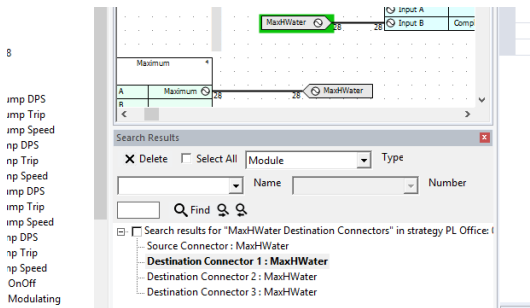

### Jumping from a Source Connector

Right-click on the source connector and choose **Jump to Destination**.

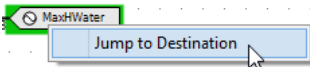

If there is only one Destination Connector, then that Connector will immediately be displayed. If there is more than one, then the **Search Results** window (below the Strategy Drawing window) will display them as a list so that you can select which one to view.

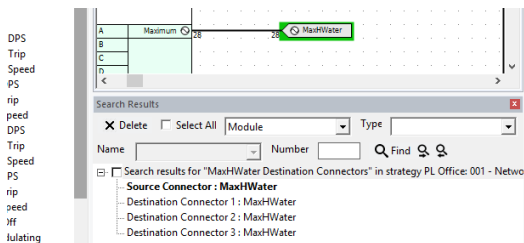

## Convert Lines to Connectors

It is possible to quickly convert an existing Line to a set of **Connectors** (one Source and one Destination).

Right-click on a Line and choose **Convert Line to Connector**.

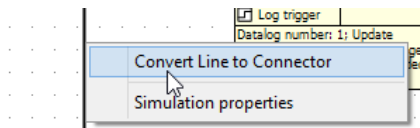

If the point is not named, you will be given the option to name it.



## VIEWING POINT PROPERTIES

The Properties panel in the CXpro<sup>HD</sup> Right-hand pane can be used to examine points and routing. To do this, select a line (representing a connection between two modules, usually meaning a point). The properties of the point are displayed in the Properties panel:

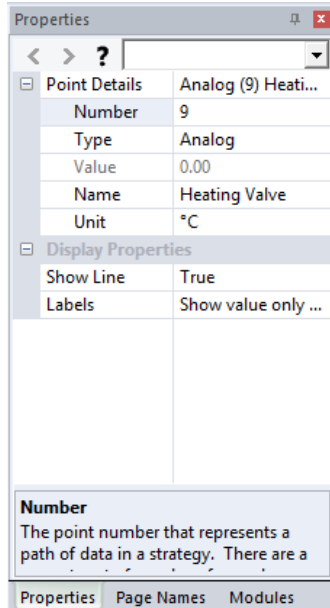

Some attributes of a point (such as Name or Unit) are editable and can be changed directly in the Properties panel.

## VIEWING BACnet PROPERTIES

If the BACnet Properties option is enabled in the Home tab of the Ribbon,

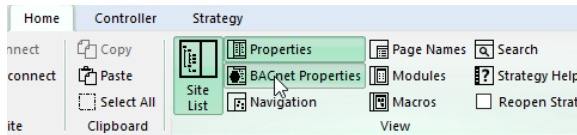

then in the right-hand pane, alongside the Properties panel, there is a BACnet Properties panel:

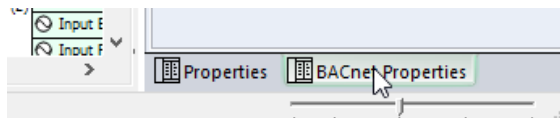

When a BACnet-exposed point (the line representing the point has hexagon indicators near each end) is selected

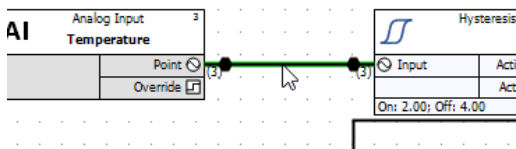

and the controller is connected in CXpro<sup>HD</sup>

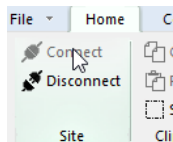

then CXpro<sup>HD</sup> will interrogate the BACnet network in real-time, and live BACnet property values for the selected point will be displayed in the BACnet Properties panel.

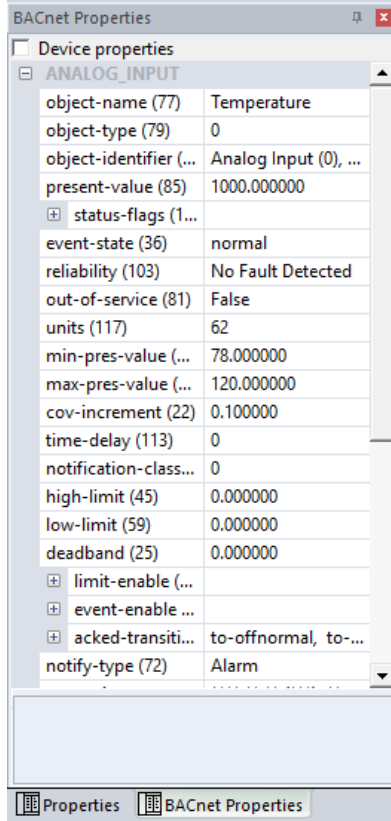

### Viewing Module BACnet Properties

The **BACnet Properties** panel can also be used to view and edit BACnet information related to certain modules as well as points.

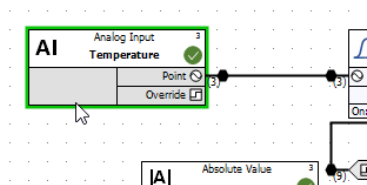

The following modules are supported:

- Binary input/output
- Analog input/output
- Setpoints
- BACnet Schedules
- Unitrion Schedules
- Broadcast transmit and receive
- Modbus Analog and Digital
- Accumulator
- BACnet Trendlogs

### Viewing Device BACnet Properties

At the top of the BACnet Properties panel there is a Device Properties checkbox:

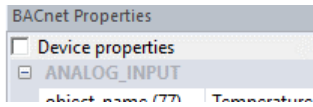

Checking this box changes the contents of the panel from the properties of the selected point or module, to the BACnet properties of the device that contains that point or module:

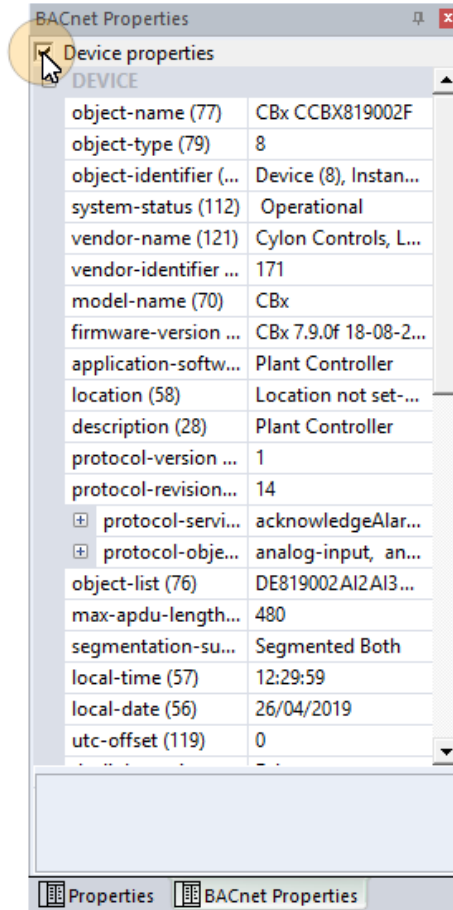
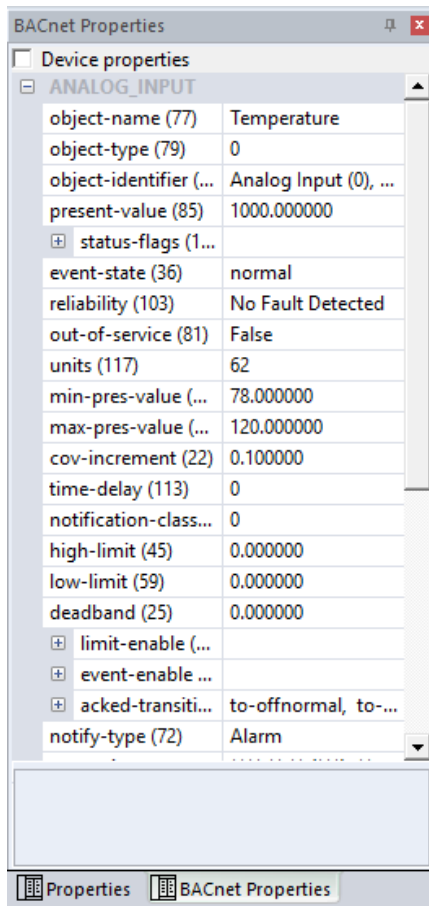

## HOW TO ADD TEXT TO A STRATEGY

You can add text comments to a strategy drawing by selecting **Add Text** from the **Strategy** tab on the **Ribbon**:

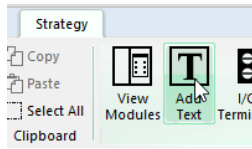

Click the drawing area at the point where you want the text to be displayed.

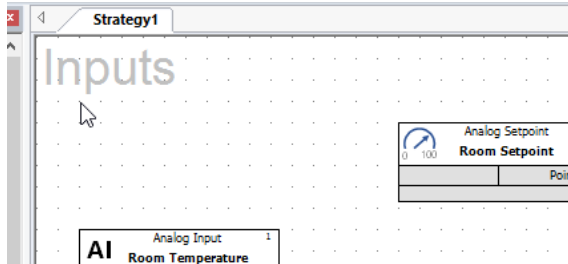

The **Add Text** dialog box will be displayed:

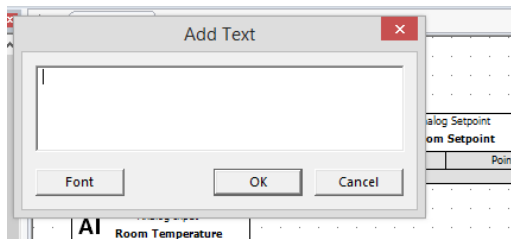

To select the type of font in which the text should be displayed, click **Font**. The standard Windows **Font** dialog box will be displayed in which you can choose a font, style, point size, etc. Once you have chosen the required font, click the **OK** button.

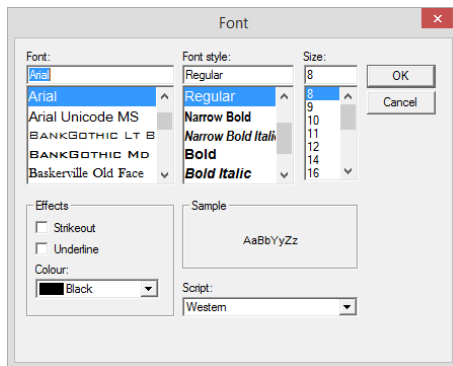

**Note:** It is recommended that you always use "True-type" fonts. When the printing is scaled, non true-type fonts do not scale properly.

In the **Add Text** dialog box, type the text that you would like to include in the strategy

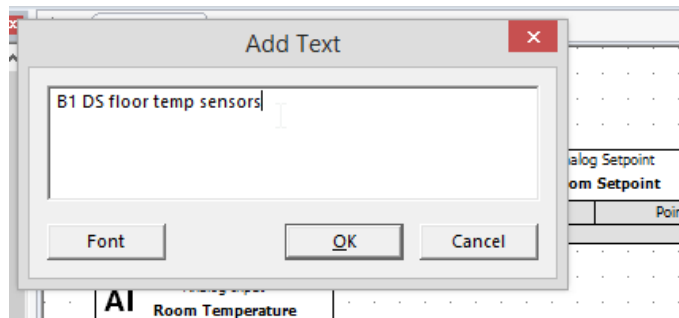

And click **OK**.

The text will then be displayed on the drawing area on the point at which you clicked the mouse.

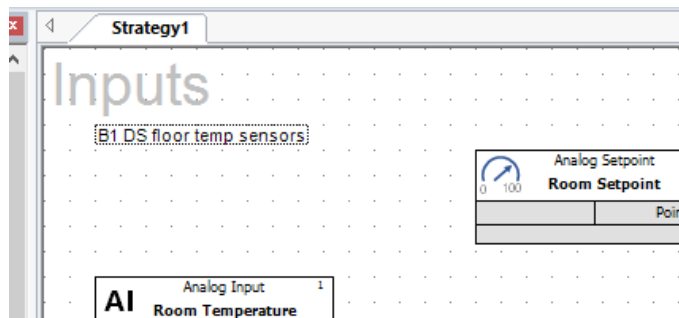

## HOW TO CHANGE TEXT THAT HAS BEEN ADDED TO THE STRATEGY DRAWING

To change text, select the text, and edit its content or font directly in the **Properties** pane.

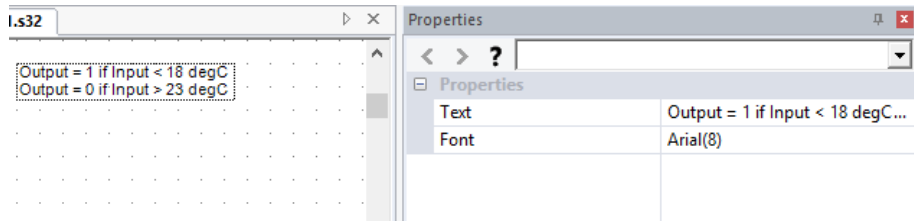

## VIRTUAL MODULES

Virtual modules are so-called because they do not result in point values being downloaded to the **ABB Cylon**<sup>®</sup> controllers, i.e. they do not represent real points. The basic function of a virtual module is to allow for greater flexibility in connecting modules, e.g. backward connection of modules. Virtual modules are also used when creating macros, as they allow one external point of a macro to be connected, via a virtual module, to many internal macro points. There are two virtual modules on a floating toolbar – one analog and one digital.

Analog Virtual Module: 

Digital Virtual Module: 

## PLACING VIRTUAL MODULES ON THE DRAWING AREA

The procedure for placing virtual modules on the drawing area is similar to that for any other module.

Select the required module from the Virtuals group in the Modules panel:

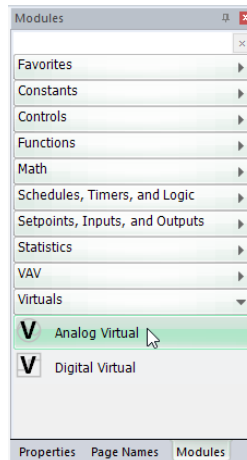

And click in the drawing area (note the cursor changes to the “Module Cursor”  during this process)

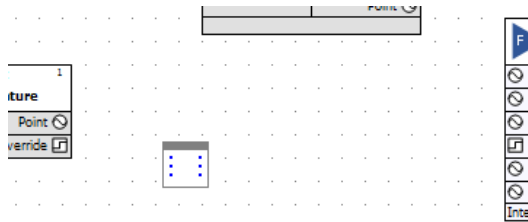

The top left-hand corner of the module’s symbol will be placed on the point where the mouse was clicked.

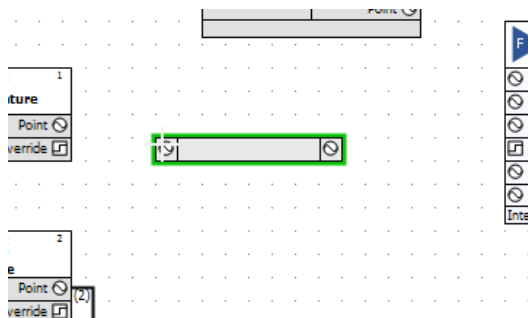

## RULES FOR CONNECTING TO VIRTUAL MODULES

1. If the point being connected to the virtual module has a point number, then this becomes the number of all the inputs and outputs of the virtual module. Any modules that are then connected will have the same point number.
  2. If the point being connected to the virtual module does not have a point number, CXpro<sup>HD</sup> chooses a new number and this becomes the number of all the inputs and outputs of the virtual module.
- Rules 1 and 2 describe how the inputs and outputs of the virtual module are numbered once a connection has been made. This is why CXpro<sup>HD</sup> will not allow you, once the first connection has been made, to connect another module that has a number. You can, however, connect a module if its point number box is blank.

## NUMBERING VIRTUAL MODULES

Since virtual modules are not downloaded, they do not use any memory in the controller and do not need to be numbered in the Block Manager like other modules.

Virtual modules have their own numbering system. The first virtual module used in a strategy is numbered V1, the second V2, etc.

## VIRTUAL MODULES IN MACROS

Virtual modules are useful when creating macros as they allow one input to be used several times.

For example, to create a macro from the strategy shown, it would be necessary to include two inputs in the macro.

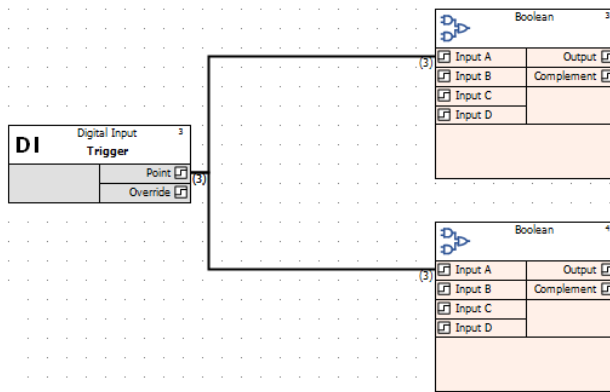

Creating the same macro with a virtual module requires just one macro input.

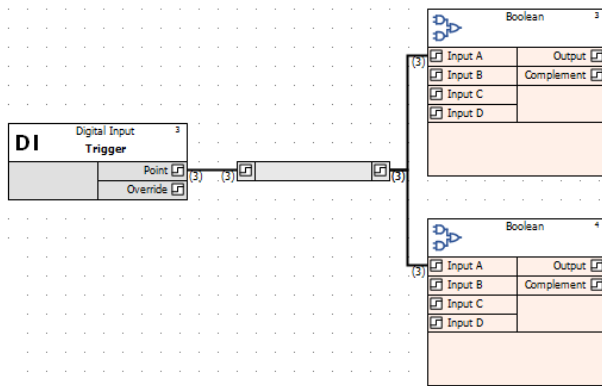

# 5 Points and Point Values

## WHAT ARE POINTS?

A Point is an area in a Controller where data is collected and stored. The data stored by the point is referred to as the Point's "value". Controllers in the **ABB Cylon**<sup>®</sup> system include input, output, set, and virtual Points.

**Note:** Cylon's Controllers are sometimes referred to as "universal controllers", where "universal" means that they can contain both analog and digital Points.

## WHAT ARE BLOCKS?

An important aspect of CXpro<sup>HD</sup> is the concept of blocks.

Blocks can be seen as units of measurement for the number of modules and points used in a strategy – one block corresponds to one module, one hardware input Point, one hardware output Point, or one virtual point.

The **Managers** dialog, accessible from the **View** menu, allows you to see at a glance which of the blocks in the controller are occupied and which are not.

When Points or strategies are downloaded to a Controller, the Controller must also be informed of how many blocks are needed to store the required information.

- If you are using Automatic Download (see page 76), CXpro<sup>HD</sup> automatically recognizes how many blocks are required and it sends this information to the Controller.
- If you are not using Automatic Download you must, when downloading Points and strategies, send specific "Setup" information to the Controller, instructing it as to how many blocks it must serve in the strategy. This procedure is called Sending Setup (see page 154).

## BLOCK NUMBERS

An important aspect of CXpro<sup>HD</sup> is the concept of blocks.

Blocks can be seen as units of measurement for the number of both modules and points used in a strategy.

- In the CBM, CBV, and CBT controllers, the Hardware Point numbers are from 1 to 1024, and strategy blocks go from 1 to 1024. Note however that only Hardware Points 1-24 are used on the CBM24, only Hardware points 1-16 are used on the CBM16, etc.

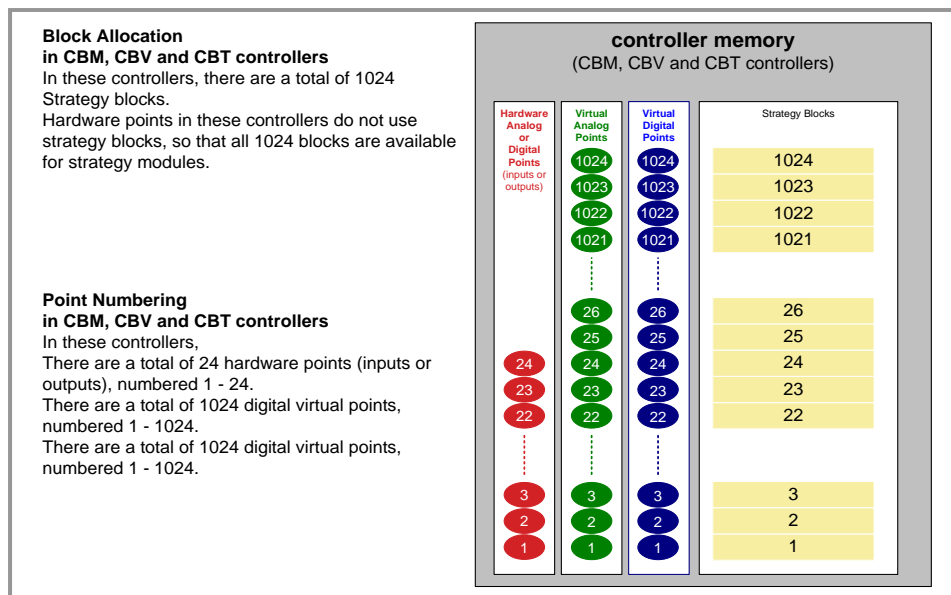



## POINT NUMBERS

In CXpro<sup>HD</sup>, the connections between modules are referred to as ‘Points’. These strategy Points can represent physical inputs and outputs on a Controller, or Analog/Binary values (referred to in CXpro<sup>HD</sup> as ‘Virtual Points’).

Each Analog Input, Analog Output, Binary Input, Binary Output, Analog Value, and Binary Value is assigned a number, and how these points are numbered depends on the controller type.

In CBM, CBV, and CBT controllers, controller terminals (i.e. inputs and outputs) - “hardware points” in CXpro<sup>HD</sup> - are assigned numbers between 1 and 24. Each terminal can be either an input or an output so that there cannot be two hardware points with the same number. For example, if there is an Analog Input 3 there cannot be an Analog Output 3 or Binary Input 3 at the same time.

**Note:** In theory, hardware Point numbers could be up to 1024, but is limited by the Controller hardware so that the current maximum is 24.

Analog Values (“Analog virtual points”) can be numbered 1-1024, and Binary Values (“Digital virtual points”) can be numbered 1 – 1024, so that there could be for example both Analog Value 3 and Binary Value 3.

**Note:** The combined number of Analog Values and Binary Values that can be exposed on a BACnet network by a single CBM or CBT is 225. As a result, it is recommended to keep the total number of defined setpoints in a strategy below this value.

However, it is possible to have up to 100 additional setpoints **that are not exposed on BACnet**. Such setpoints in effect act as constants, because they cannot be changed by the strategy nor via BACnet, but can be set using CXpro<sup>HD</sup>.

In strategy drawings generated by CXpro<sup>HD</sup> for CBM, CBV, and CBT controllers, it is possible to identify a strategy Point’s nature as follows:

- If the number has brackets around it is a “hardware point” – Analog Input, Analog Output, Binary Input, or Binary Output.
- If the number is not bracketed but is connected to a circular connection point, it is an Analog Value (“analog virtual point”).
- If the number is not bracketed but is connected to a square connection point, it is a Binary Value (“digital virtual point”).
- If the line representing the point has a hexagon near each end, then that point is exposed on the BACnet network.

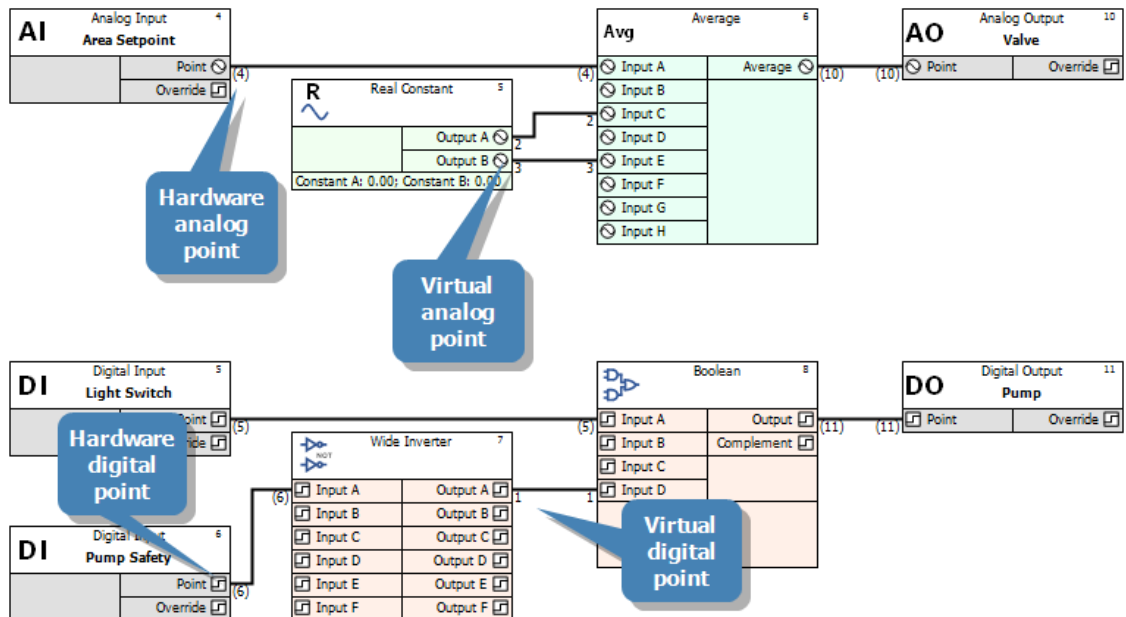

Point exposed over BACnet:

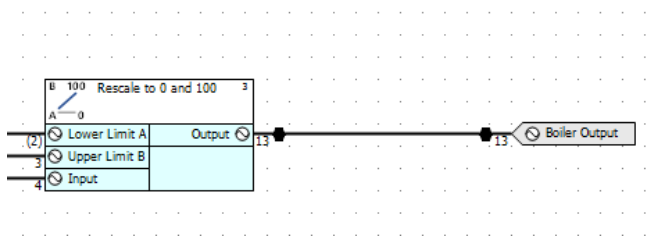

## DEFINING HARDWARE POINTS

Hardware points are the inputs and outputs of Field Controllers.

To define a hardware point it is necessary to define the following features:

- Point number
- Point name
- Point type (input, output, digital, analog)
- Unit of measurement
- Damping (for analog inputs only)

Once the required hardware points have been defined in CXpro<sup>HD</sup>, they are then downloaded to the Field Controller for which they are intended.

## HOW TO DEFINE HARDWARE POINTS

The procedure for defining hardware points is as follows:

- Specify (Target) the controller for which the hardware point is being defined
- **Choose the module** from the modules bar
- **Place the module** on the drawing area
- **Complete** the module dialog box
- Save the hardware point definition
- Log in to the Field Controller
- Download the hardware point definition to the Field Controller

### Defining Hardware points – Target the controller

in the **Site List** select the BACnet Router and Field Controller that you want to target. This specifies the Field Controller on which the hardware point is being defined and the location in the database on the PC's hard disk in which the point definition will be stored.

### Defining Hardware points - Place the module on the drawing area

Once you have selected a module from the **modules bar**, place it on the drawing area by simply clicking the drawing area. A dialog box will appear prompting you to enter a name for the hardware point.

Enter a name and click **OK** to close the dialog box.

The top left-hand corner of the module's symbol, i.e. the graphical symbol for the analog input point, will be placed on the point on the drawing area where the mouse was clicked.

### Expandable I/O – Hardware Points on CBX + FLX devices

In the strategy drawing, IO blocks can be added up to the total on the configured FLX modules plus the CBX onboard IO.

**Note:** If a FLX module is deleted from a CBX configuration (in Controller Properties) after the strategy drawing has been set up, the blocks associated with that FLX's IO will be 'greyed out' to indicate that they are inactive.

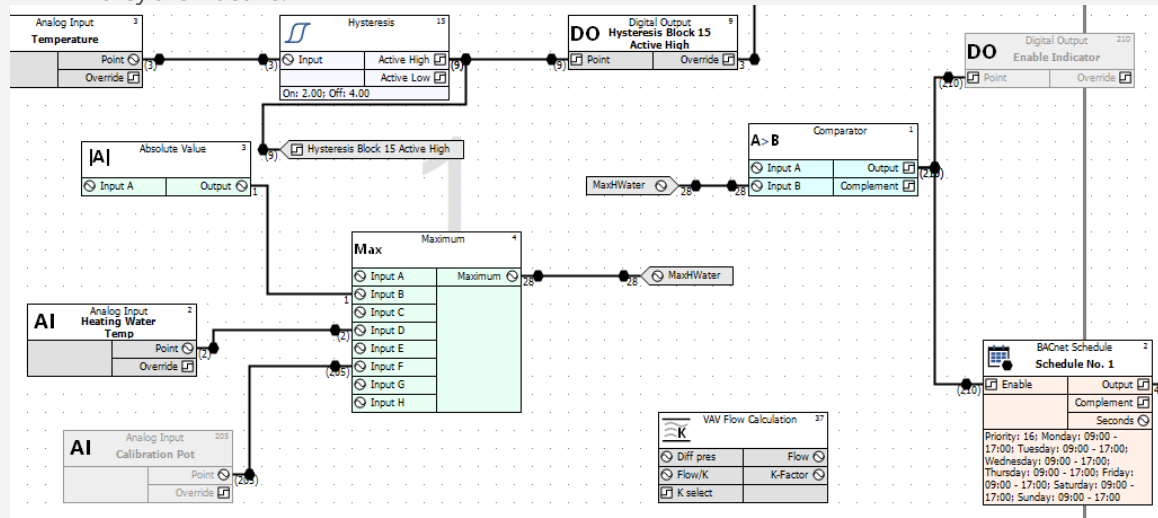

**Note:** Unlike CBM UniPuts, if UniPuts on CBX/CBXi devices are configured as Analog Inputs, they have all of the parameters that are available in Universal inputs. Also, the "Operation Mode" parameters, which apply only to certain CBM UniPuts, are not used by CBX/CBXi.

### Defining Hardware points - Save the hardware point definition

Save the edited strategy by choosing **Save** or **Save As...** from the **File** menu. The **Save As** dialog box appears:

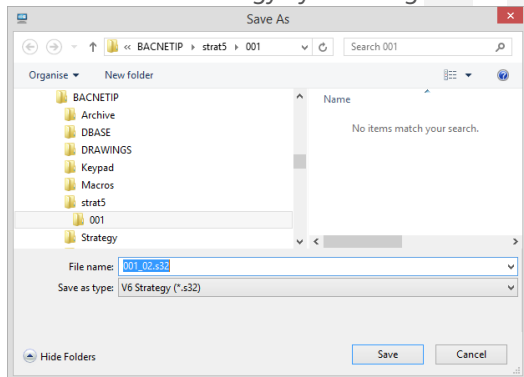

Enter a name under which the strategy should be saved. CXpro<sup>HD</sup> enters a default file name that identifies the BACnet Router and Field Controller for which the strategy has been designed, e.g. if Field Controller #3 on BACnet Router #1 was connected to a VAV, its strategy might be named: "001\_03VAV.s32".

When the **Save As** dialog box is complete, click **OK**. The name of the strategy will appear in the Drawing tab:

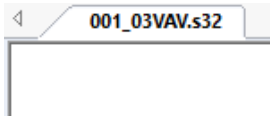

## Connect to the controller

Connect to the controller by clicking the **Connect** button on the **Strategy** tab of the **Ribbon**.

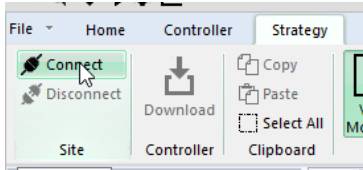

## Download the hardware point definition.

You can download a strategy to a controller in just one step, by choosing **Download** from the **Controller** tab of the **Ribbon**.

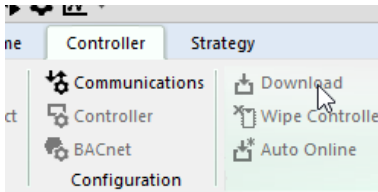

**CXpro<sup>HD</sup>** will automatically wipe the Field Controller's memory, download the hardware point, and send the set-up to the UC, i.e. the number of blocks it is to serve. While it is doing this, it will display the **Downloading** window. As the point is being downloaded, the **Downloading** window displays the progress and in the **System status** section, it shows which of the 3 stages (wiping memory, downloading strategy, or sending set-up) **CXpro<sup>HD</sup>** is currently completing. If only one hardware point is being downloaded, the process will take place so quickly that the downloading window will appear only for a brief moment.

It is more usual to download an entire strategy, with several hardware points and other modules. In that case, the **Downloading** window will remain visible for longer and the progress of the download will be measured in the progress bars.

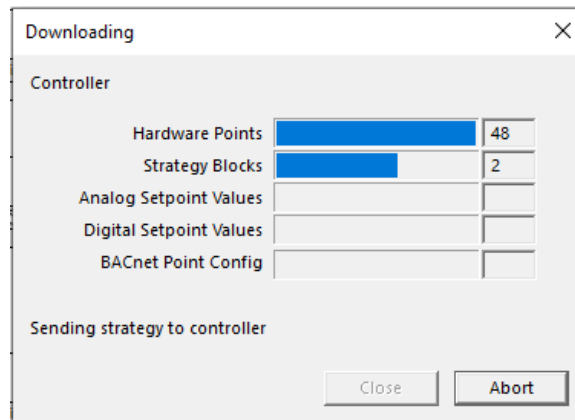

## SUMMARY OF PROCEDURE FOR DEFINING HARDWARE POINTS

In practice, the procedure for defining hardware points is as follows:

- Define all hardware points whose values are already known, in the module dialog boxes and place the corresponding modules somewhere on the drawing area.
- Save the strategy.
- Click Communications Setup from the Communications menu and enable Automatic Download.
- Log in
- Choose Download from the Communications menu.
- 

## POINT NUMBERS FOR INPUTS AND OUTPUTS

When another input module is selected, CXpro<sup>HD</sup> automatically assigns it to it the next unused input, i.e. the unused input with the smallest point number.

Defining digital and analog outputs follows the same principle. As outputs are numbered in the range 9 to 16, CXpro<sup>HD</sup> assigns point number 9 to the first output.

For CBX and CBXi devices, point numbers are defined by the I/O module in which they reside – internal I/O on the CBX/CBXi device are I/O module “0”, any attached FLX devices are I/O modules 1,2 or 3

I/O Module	Terminal Number	Type
CBX-8R8	1 ... 8	Universal Input
	9 ... 16	UniPut™
FLX-8R8 address 0 (FBXi only)	1 ... 8	Universal Input
	9 ... 6	UniPut™
FLX-8R8 address 1	101 ... 108	Universal Input
	109 ... 116	UniPut™
FLX-8R8 address 2	201 ... 208	Universal Input
	209 ... 216	UniPut™
FLX-8R8 address 3	301 ... 308	Universal Input
	309 ... 316	UniPut™

## A SHORT CUT TO DEFINING HARDWARE POINTS

To save time when defining the hardware points you can bring the definitions directly to the database by using the **Database Interface**.

The types (“A” for analog, “D” for digital), point names, and point numbers and units can be written as comma-separated or tab-separated lists in a word processing application, copied and pasted via the clipboard to the Database Interface. This avoids unnecessary writing work and typing errors. Using external applications for text handling also saves time because of their Copy, Search, Replace, and Pasting features.

The point list shown below was created in **Microsoft Windows Notepad**. Other software applications, such as **Excel** and **Word** may also be used.

```

A   Room Temperature 1           °C   1
A   Room Temperature 2           °C   2
A   Outair Temperature South-East °C   3
A   Outair Temperature North-West °C   4
A   Supply Water Temperature 1    °C   5
A   Supply Water Temperature 2    °C   6
A   Valve 1                       %    9
A   Valve 2                       %    10
D   Pump 1             ON/ OFF 11
D   Pump 2             ON/ OFF 12
    
```

When preparing a hardware point definition list you must separate the values (type, point name, unit, point number, etc.) by using tabs or commas, not spaces.

**Note:** This shortcut for defining hardware point values should only be used for UCs that do not already have hardware point definitions in the database on the PC’s hard disk, since existing database entries are not deleted. The Database Interface does not check for uniqueness. This means that there is a danger of defining more than one entry per point, which will cause a lot of confusion in the later use of the point in other programs.

## WHAT ARE UNIPUTS™?

A UniPut™ can act as an input or an output so that you can now have a controller that fits your BMS design exactly - no need to use an extra controller to gain an extra output while leaving an input on the original controller unused. BMS sites can make more efficient use of a smaller number of controllers, saving on cost and complexity.

A UniPut™ can be configured as any one of the following:

- an Active Input, reading between 0 ... 10 V at 40 KΩ, with 9-bit resolution.
- an Active Output, outputting 0 ... 10 V at a maximum load of 20 mA
- a Digital Volt-Free contact.
- a digital input detecting the presence or absence of 24Vac

or

- a relay switched output.

The **ABB Cylon®** range of controllers has several different combinations of UniPuts™ and standard Universal Inputs.

UniPuts™ are used in controller strategies through standard Analog and Digital Input and Output modules. However, before it is possible to add a module for a UniPut™ to the strategy, the UniPut™ must be configured using CXpro<sup>HD</sup>'s I/O Terminals dialog box.

## CONFIGURING THE FIELD CONTROLLER'S INPUTS AND OUTPUTS

Cylon® controllers can have a mixture of Universal Inputs and UniPuts™. The Universal Inputs are fixed as inputs, but UniPuts™ may be configured as analog or digital inputs or outputs. Universal Inputs and UniPuts™ are configured using the I/O Terminals dialog.

### HOW TO OPEN THE "I/O TERMINALS" DIALOG.

The I/O Terminals dialog can be opened by clicking the I/O Terminals button in the Strategy tab of the Ribbon:

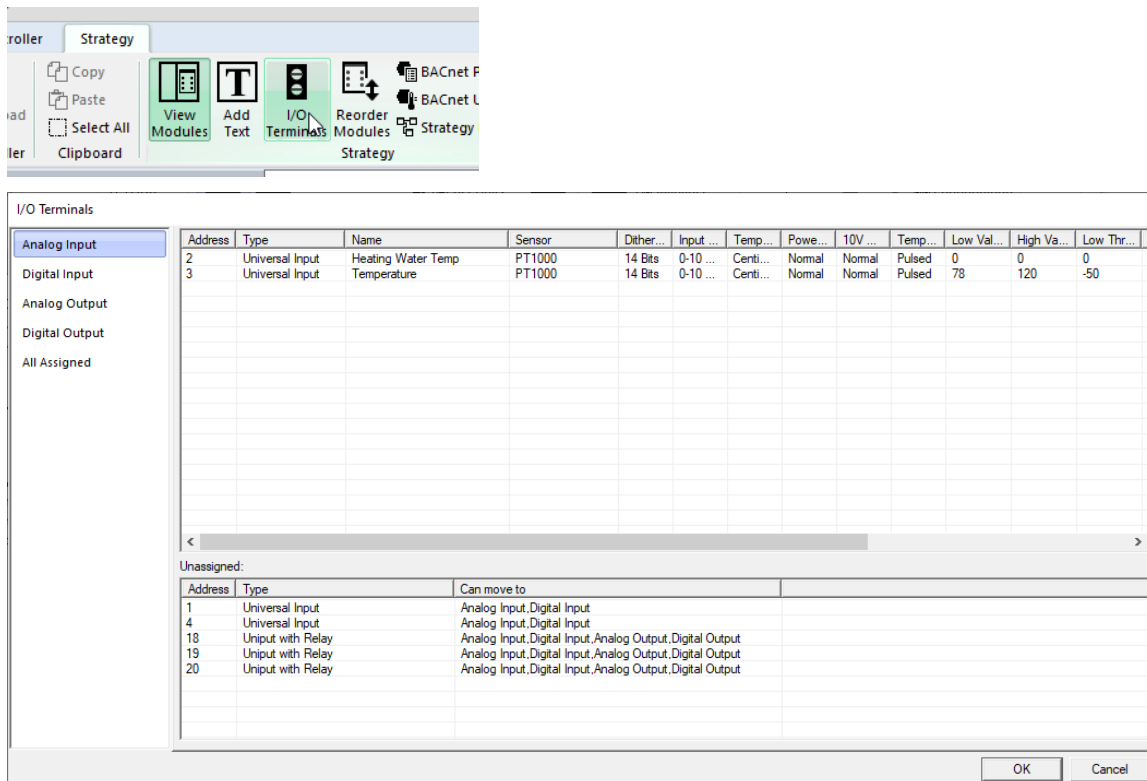

The I/O terminals that have already been configured are listed in the top panel. The configuration of these I/O terminals can be adjusted directly in the top panel.

I/O terminals that have not yet been configured are listed in the bottom **Unassigned** panel. For each of these, the types of I/O as which it can act are listed in the **Can move to** column.

In the left-hand panel there is a list of the I/O natures to which terminals can be assigned – **Analog Input**, **Digital Input**, **Analog Output**, and **Digital Output**.

To assign an Unassigned terminal, first select an appropriate “nature” in the left-hand panel,

I/O Terminals						
Address	Type	Name	Outpu...	Low Val...	High V	
There are no items to						



then select the Terminal and drag it into the top panel.

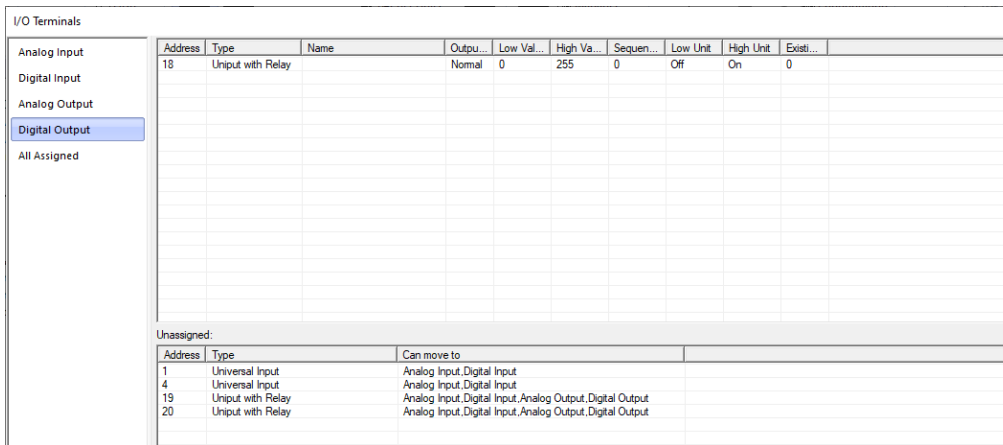
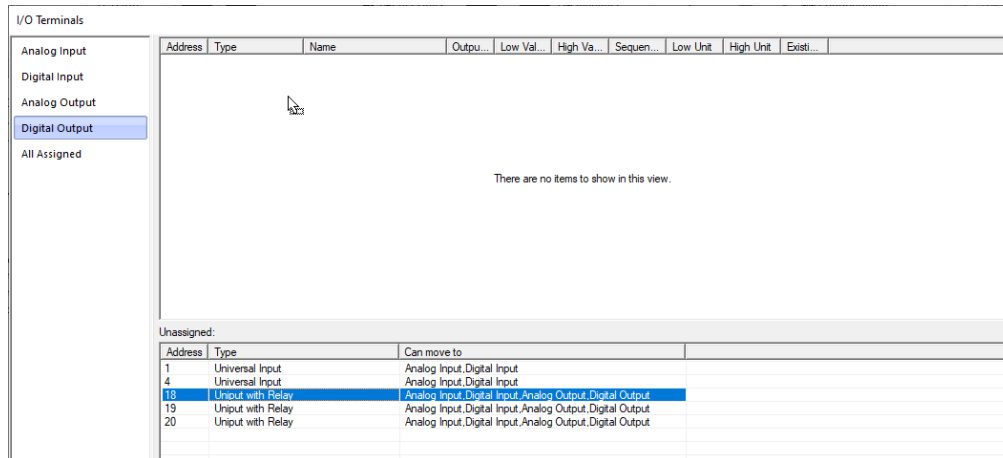

**Note:** Terminals marked Universal Input type are not UniPuts™, so they cannot be selected if Analog Output or Digital Output is selected in the left-hand panel

Enter a Name for the new point:

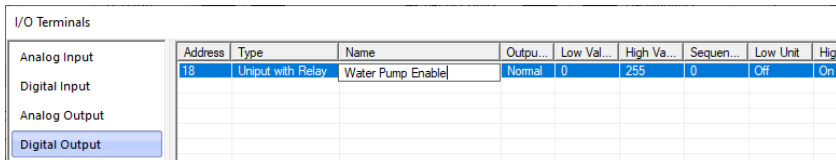

Adjust the parameters of the I/O terminal as required:

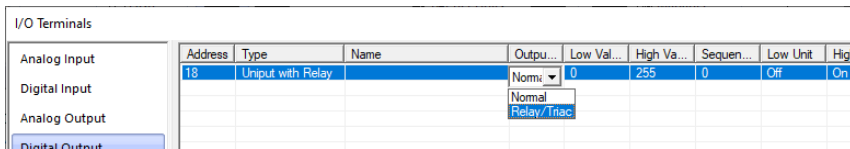

Repeat this process until all required UniPuts™ have been configured.

**Note:** When the I/O Terminals dialog is closed, point modules will be added to the strategy drawing for any newly-configured terminals which were not already in the strategy.

## CHANGING THE CONFIGURATION OF A UNIPUT™ OR UNIVERSAL INPUT

Any editable parameter of a configured I/O terminal can be adjusted by selecting it in the **I/O Terminals** dialog:

Dither...	Input ...	Temp...	Powe...	10V ...	Temp...	Low Val...	High Va...	Low Thr...
14 Bits	0-10	Centi...	Normal	Normal	Pulsed	0	0	0
14 Bits	0-10 ...	Centi...	Normal	Normal	Pulsed	75	120	-50

An I/O terminal's behavior can be changed from one nature to another, e.g. from Digital Output to Analog Output, by dragging the point to a different entry in the left-hand Pane:

I/O Terminals

Address	Type	Name	Output...	Low Val...	High Va...	Sequen...	Low Unit	High Unit	Existi...
18	Uniput with Relay	Water Pump Enable	Normal	0	255	0	Off	On	0

Left-hand pane: Analog Input, Digital Input, **Analog Output**, Digital Output, All Assigned

I/O Terminals

Address	Type	Name	Output...	Low Val...	High Va...	Sequen...	Low Unit	High Unit	Existi...
---------	------	------	-----------	------------	------------	-----------	----------	-----------	-----------

Left-hand pane: Analog Input, Digital Input, **Analog Output**, Digital Output, All Assigned

I/O Terminals

Address	Type	Name	Low Val...	High Va...	Low Str...	High Str...	Output ...	Sequen...	Unit	Existi...
17	Uniput with Relay	Chiller	0	10000	0	100	0.000000	0	°C	0
18	Uniput with Relay	Chiller	0	10000	0	100	0.000000	0	°C	0

Left-hand pane: Analog Input, Digital Input, **Analog Output**, Digital Output, All Assigned

## Example: Configuring Analog Input module properties

The screenshot shows the configuration interface for an Analog Input module. On the left, a schematic diagram displays two AI blocks. The top block is labeled 'AI Analog Input Outside Air Temperature' and is highlighted with a green border. The bottom block is labeled 'AI Analog Input Heating Water Temp'. On the right, the 'Properties' window for 'Analog Input [1]' is open, showing various configuration parameters.

General Information	
Type	Analog Input
Service Order	1
Name	Outside Air Temperature
Synchronised Status	Checking...
Constants	
Point type	Input Analog
Low threshold	78
High threshold	120
Lower sensor range	-50
Upper sensor range	150
Input error	0.0000
Exponential filter	20
Sensor type	PT1000
Unit	°C
Averaging	0
Outputs	
Point	Analog (1): 0.00 Outside Air T...
Manual override	Digital

## General Information

### Type

(not editable) shows that this is an Analog input.

### Service Order

(not editable) indicates the order in which this block will be processed by the controller.

### Name

Shows the text identifier for the point, which must be no more than 24 alphanumeric characters. Spaces, commas, full stops may also be used. Each point in a Field Controller must have a point name that is unique within that controller.

### Synchronised Status

Shows whether the strategy drawing matches the strategy in the connected Controller.

## Constants

### Low Input Threshold / High Input Threshold / Low Strategy Value / High Strategy Value

The threshold settings specify the on/off turnover point on a digital input or output.

### Input Error

A constant with the same unit as the input value, which is added to the input value to compensate for errors in input arising from factors such as resistance of long cables or positioning of sensors. Temperature values (sensor type PT1000) are corrected in mV. To compensate for 1 °C, the input error is 2.5 mV. For example, a decrease in temperature of 2 °C requires an input error of -5.0 mV to be entered. This feature is only available for analog passive inputs.

**Exp. Filter Constant**

An individual time constant for the analog input, behaving as a damping filter. The measured input value will be averaged over the time specified in seconds by the **Exponential Filter** constant, so that short-term variations of the measured value can be filtered out if the **Exponential Filter** value is longer than the sensor response time.

**Sensor Type**

Select the required filter from the **Sensor Type** list. Some of the available options are:

- **Pt1000**: This configures the analog input for reading temperatures from a standard Pt1000 sensor. The Controller will convert the measured resistance (voltage) to a temperature signal.
- **0-10 V**: This converts the hardware voltage signal **0...10 V DC** to a software value in the range **0...100 %**. For example, the voltage signal **6.7 V DC** will be converted to **67.0 %**.
- **0-20 mA**: This converts the hardware current signal **0...20 mA** to a software value in the range **0...100 %**. For example, a current of 15.0 mA gives the software a value of **75.0 %**.
- **Pulse(V/F)**: This is designed for reading voltage-free contacts, which can be operated at a frequency of up to 12 Hz. The value of the input will be incremented by 1 after each detected pulse. Evaluation and resetting of the counter will be done by using the Meter Module (module 63).

Additional sensor types can be allowed for by defining extra units of measurement - see *Appendix :: Adding units of measurement to the system* on page 205.

**Unit**

The **Unit** list box contains a collection of text strings, one of which will be displayed together with the point value. Choose from the list the type of unit that corresponds to the type of input, e.g. if an analog input point represents a temperature reading in degrees Celsius, you may choose DegC from the Units list box. If necessary, additional units may be defined in the `C:\CXproHD\ (SITENAME)\SYSTEM\site.ini` file. *Appendix :: Adding units of measurement to the system* on page 205 contains details of how this is done.

**Outputs****Point**

The output of the Analog Point module assumes the type, name, and units of the point module. A point number is automatically assigned (though this can be edited by selecting the connecting line, which represents the point itself)

**Note:** Point numbers 1...8 represent controller inputs 1...8.  
Point numbers 9...16 represent controller outputs 1...8.

## VIEWING USED BLOCKS

To check which blocks have been used in a strategy, select **Strategy Details** from the **Strategy** tab of the **Ribbon**:

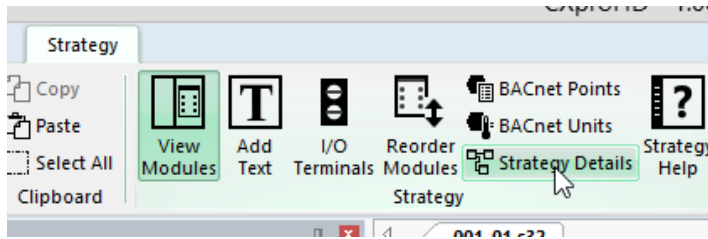

This opens the **Strategy Details** dialog:

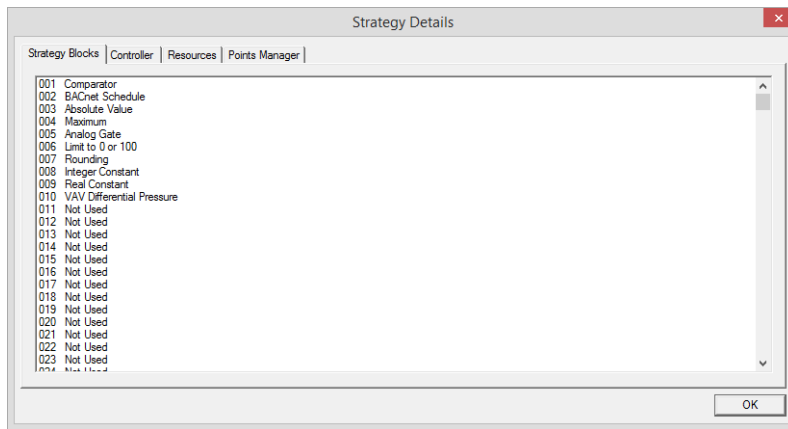

### Viewing the list of blocks

Click on the **Strategy Blocks** tab to see which of the available blocks have been used in the active strategy and which have not.

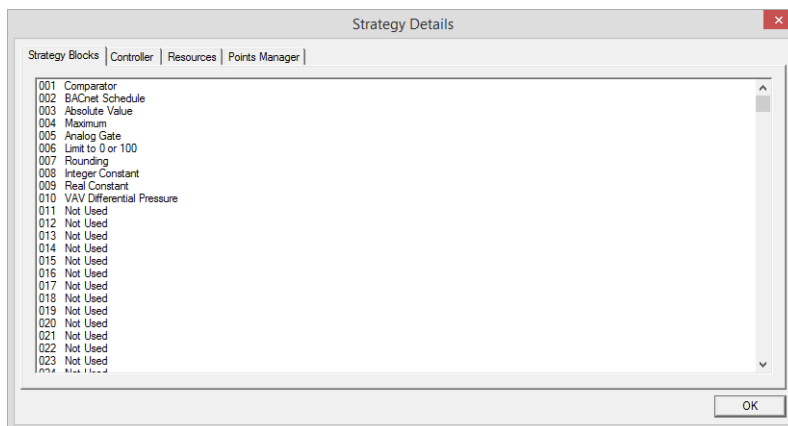

In the above example, the **Strategy Blocks** tab indicates that the first block (block no. 001) is being used as a **Comparator** module.

Block 002 is an **BACnet Schedule** module, block 003 is an **Absolute Value** module etc.

Blocks 011 to 023 have not been used in the strategy.

To view the remaining blocks (in the above example, blocks 024 ... 1024), use the horizontal scroll bar to move down the **Strategy Blocks** tab.

## Viewing the blocks associated with each point

The **Points Manager** tab allows you to examine points in a strategy, listing the strategy blocks to which each point is connected.

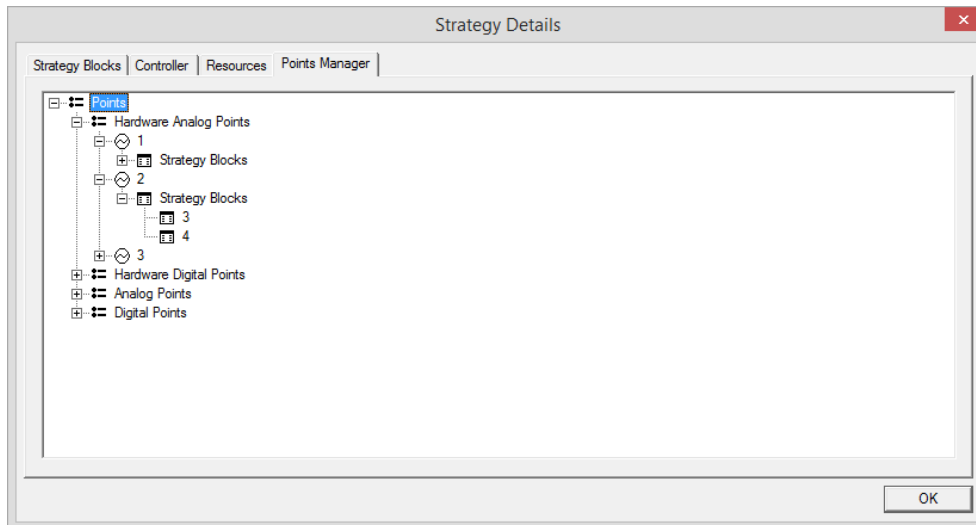

In this example, Analog Point number 2 is connected to strategy blocks numbered 3 and 4.

## KEEPING CXPRO<sup>HD</sup> AND CONTROLLER STRATEGIES IN SYNC

### STRATEGY COMPARE

When connected to a site, it is possible to compare the strategy in CXpro<sup>HD</sup> with that in the Controller.

To compare CXpro<sup>HD</sup> and Controller strategies,

Connect to the Controller by clicking on the **Connect** button in the **Home** tab of the **Ribbon**:

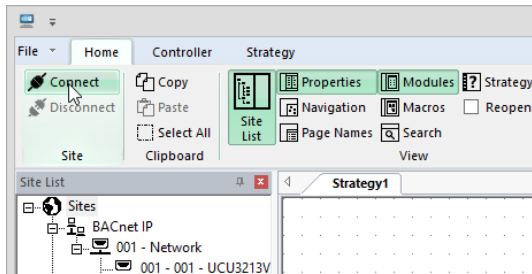

Right-click on the Field Controller in the **Site List** and select **Strategy operations** > **Compare Strategy To Controller**,

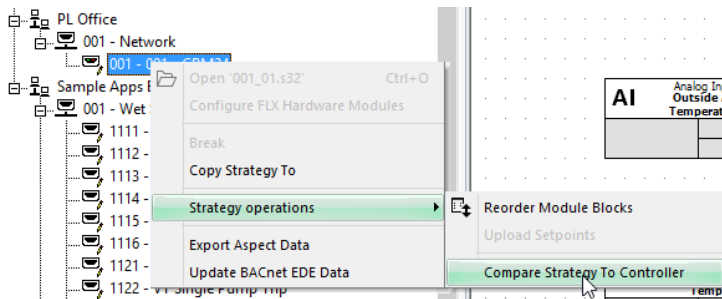

Alternatively, you can select **Compare** from the **Controller** tab of the **Ribbon**.

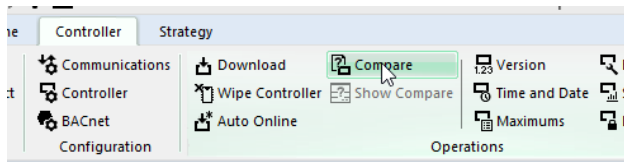

Only strategy modules are compared.

**Note:** Parts of the strategy that can be modified using tools other than the **Engineering Tool** (e.g. **CCView**) are not compared. For example, the sample interval on a **Datalog** module is excluded from the comparison, but the **Type of datalog** is included.

## Compare Process

When the Compare process is requested, the **Select Items to Compare** dialog is displayed:

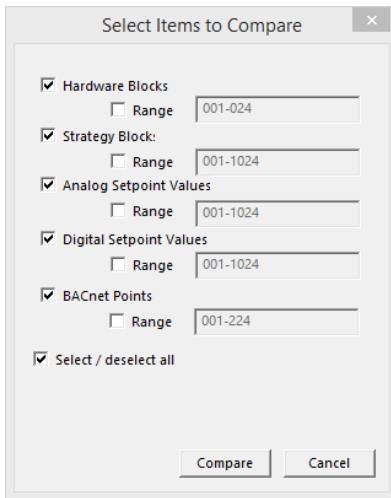

This allows specific subsets of the strategy to be compared if required.

Clicking the **Compare** button starts the process, and shows the **Uploading** progress dialog:

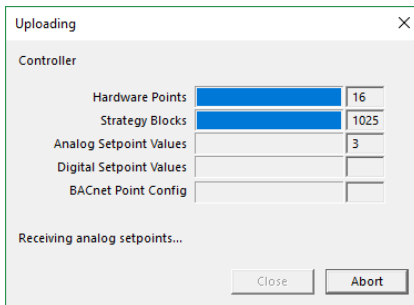

and when the upload is complete, a comparison report dialog is displayed

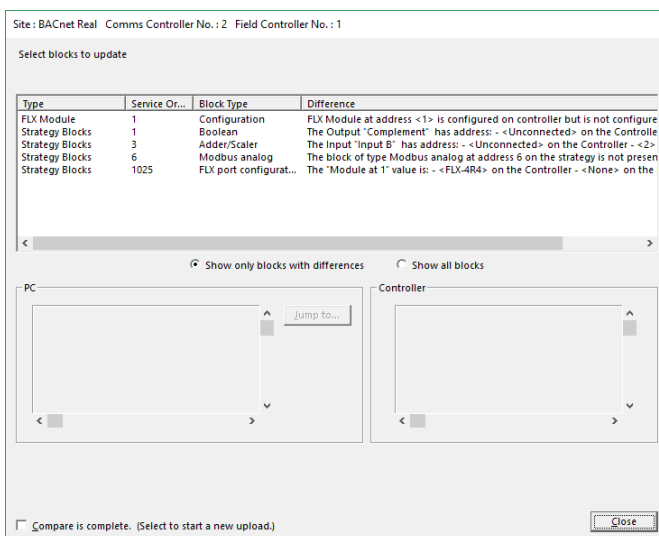

This dialog lists all of the differences between the PC version of the strategy and the Controller version, with a facility to jump to each of the modules that contains a difference, so that the difference can be manually resolved.

When the differences have been resolved, clicking on the **Close** button terminates the Compare process.



## STRATEGY SYNCHRONIZATION

CXpro<sup>HD</sup> will evaluate whether its copy of the strategy and the Controller's are fully synchronized at the following times:

- When a module is selected in the strategy drawing
- When a strategy is closed following a partial download
- When **Scan Mode** is enabled

If any potential discrepancy is found, the user will be prompted to run the **Strategy Compare** feature.

Modules in the drawing that do not match the controller strategy are marked with an icon showing a red circle containing an "x" to indicate that it is no in sync:

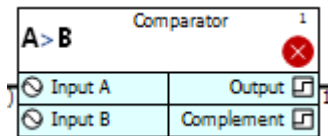

The user is not blocked or forced to take any action, and no changes take place in the background.

**Note:** The checks apply to all strategy modules with the following exceptions:

- Macros
- DI Modules
- Set Point Modules
- IO Modules (On UC16 controllers)
- Comment Modules

When a module properties are edited:

When a module is selected, its **Synchronised Status** is displayed in the properties inspector:

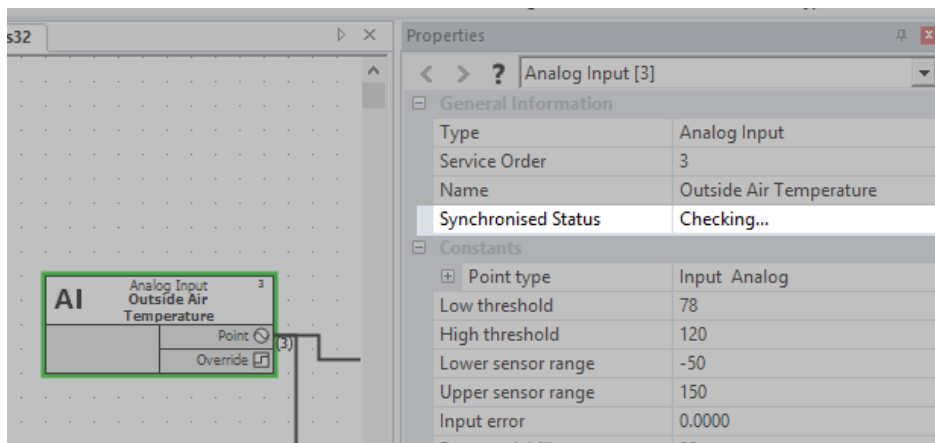

When a strategy is closed following a partial download:

A partial download takes place when the **Automatic Download** feature is disabled. In this case, selecting **Compare** from the **Controller** tab of the **Ribbon** will open a **Select items to Download** dialog allowing different subsets of the strategy to be downloaded individually.

This dialog is similar to the **Select Items to Compare** dialog used in the compare process (see *Strategy Compare* on page 87).

However, if you carry out a partial download the setup block is not downloaded. The next time you close the strategy, the Synchronisation process will register a discrepancy between PC and Controller strategies. When this happens, a warning will be displayed stating that the “setup block was updated but not downloaded” and suggesting that the setup is downloaded:

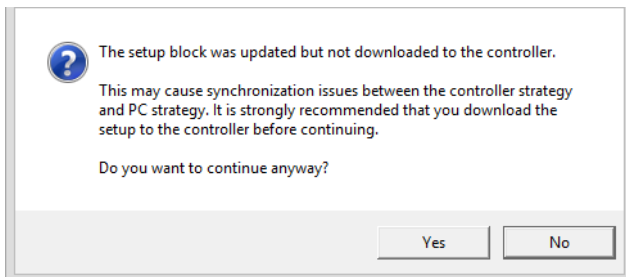

Clicking on the **No** button will allow you to save the setup block. If you do not wish to do so, click the **Yes** button and the strategy will be closed without updating the setup block on the Controller.

### When Scan Mode is enabled

When **Scan Mode** is activated (see *Activate scan mode* on page 124) the PC version of the strategy is compared to the Controller version and if any discrepancies are found, the mismatched modules will be identified by a flashing ‘highlight box’ and a message in the status bar will inform the user

## READING LIVE POINT VALUES (LIVELOG)

The LiveLog feature in CXpro<sup>HD</sup> allows you to read the values of points in the controllers on your site (i.e. it reports “live” or in real-time from the site).

As well as reading point values, the LiveLog also scans time schedules, the BMS network, and its Fieldbusses, and, if configured to do so, it will log those values to a text file. It can also show HOA values.

## CONFIGURING LIVE LOG

LiveLog can scan just one strategy, can either append to the log or wipe the log each time it starts and can write the log to a file for later analysis.

To set up these options, select LiveLog Setup from the Controller tab of the Ribbon

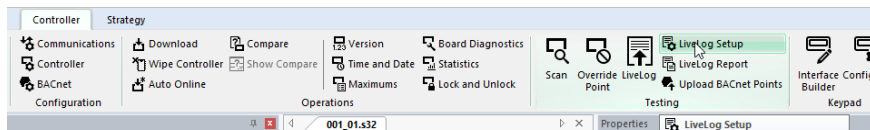

This opens the LiveLog Setup dialog.

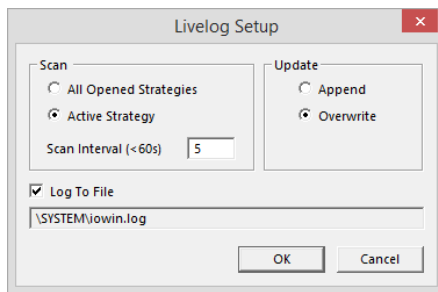

In the Update section, select Append to cause the LiveLog to add new scan data to the end of the existing list, or Overwrite to cause the LiveLog list to be replaced each time a scan is completed.

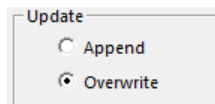

If you chose to scan the Active Strategy only, enter a number between 1 and 60 in the Scan Interval edit box. This represents the number of seconds CXpro<sup>HD</sup> will remain idle after scanning the strategy before it will scan the strategy again. (The LiveLog continuously scans the strategy until you press the Stop Scan button on the LiveLog dialog)

If you would like the results of the LiveLog to be written to a text file and saved, click the Log to File checkbox. By default, logs are saved to \SYSTEM\iowin.log

To view the contents of the LiveLog text file, click LiveLog Report in the Controller tab of the Ribbon:

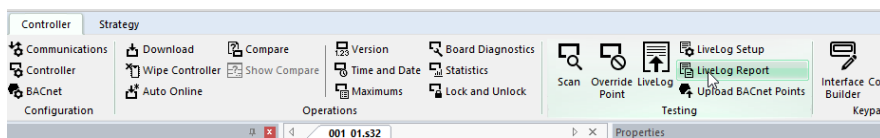

This will open the log file in your default text editor:

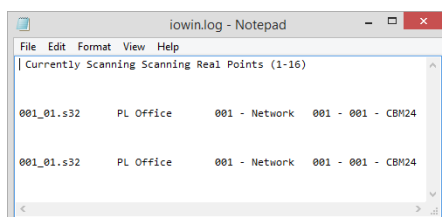

## RUNNING LIVELOG

Select from the **Site List** the site the BACnet Router and Field Controller containing the point that is to be read.

Connect to the controller by clicking on the **Connect** button in the **Home** tab of the **Ribbon**:

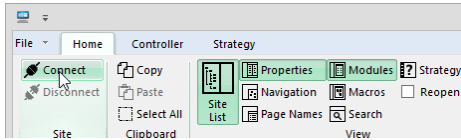

Activate **LiveLog** by clicking the **LiveLog** option in the **Controller** tab of the **Ribbon**

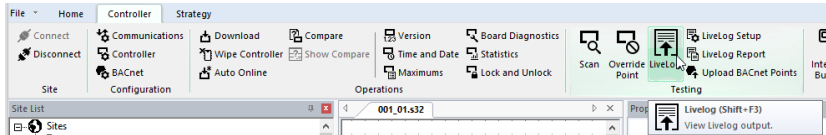

This opens the **LiveLog** dialog:



## LIVELOG - SCANNING DEFINITION

In the **LiveLog** dialog, you can view the following parameters for the **LiveLog**, and change them where it is appropriate to do so:

- The **type of points** to be scanned
- Whether or not points will be **overwritten**

### Strategy Target

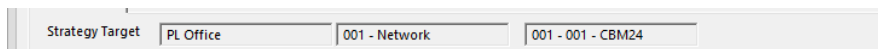

This window shows the target of the currently selected strategy. The values cannot be changed in the **LiveLog** dialog.

### Scanning definition

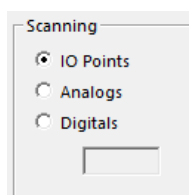

The **Scanning** section of the **LiveLog** window allows you to decide which values to scan.

To scan the values of the controller’s hardware points, click **Hardware Points**.

To scan analog points only, click **Analogs** in the scanning section. To scan a specific number of analog points, enter a range of point numbers in the edit box under **Digitals**.

To scan digital points only, click **Digitals** in the scanning section. To scan a specific number of digital points, enter a range of point numbers in the edit box under **Digitals**.

### Override Status

When a scan has been stopped, you can change the override status of any point listed in the **LiveLog** window by selecting the point from the list and clicking on the **Override** button at the bottom left of the window.

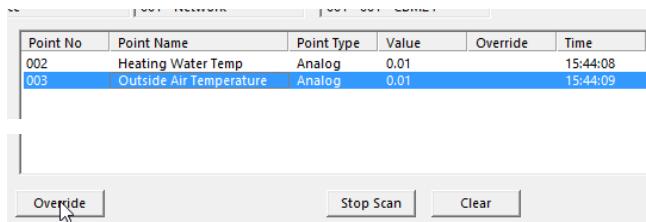

This opens the **Override Hardware Point** dialog, where the current override status of the point is displayed and can be changed if necessary.

## MANUALLY OVERRIDING POINT VALUES - THE OVERRIDE POINT DIALOG

### OVERRIDING POINTS

Point values can be overridden using the **Override Hardware Point** dialog, which allows you to set a point in a strategy to a particular value, regardless of conditions at a controller’s inputs or outputs, or conditions within the strategy itself.

- When a hardware **output** is manually overridden (disabled), the modules in the strategy do not affect the point value.
- When a hardware **input** is manually overridden (disabled), the hardware signal which is connected to the input (PT1000, transmitter, dry contact, etc.) is ignored by the input.

In both cases, the overridden hardware point keeps the value that is assigned to it in the **Override Point** dialog.

The only way to change the value of a hardware point which has been manually overridden to another specified value is to use the **Override** option again, assigning a new value in place of the first.

**Note:** Some specific controllers, such as **CBX-8R8-H** and **FLX-4R4-H**, have “HOA” controls built-in to them. When these **HOA** controls are active, **CXpro<sup>HD</sup>** cannot affect them but can display the overridden values, but not affect them.

Removing manual override status from a hardware point (enabling) means that the point can now be influenced by the connected hardware or strategy once again. The length of time that a hardware point will remain in the overridden state can be set in **CXpro<sup>HD</sup>**.

It is only possible to disable and enable hardware point values from **CXpro<sup>HD</sup>** if the PC is connected to a controller (either directly or via a BACnet Router) and **CXpro<sup>HD</sup> Connect** button is active.

Whether hardware points are overridden by the **CXpro<sup>HD</sup> Override Point** dialog, or by **HOA** switches on the Controller itself, **CXpro<sup>HD</sup>** is aware of the override state and value and displays it in the **LiveLog** window.

Point No	Point Name	Point Type	Value	Override	Time
209	Anl Output 209	Analog	46.00	HOA	11:31:09

Point No	Point Name	Point Type	Value	Override	Time
209	Anl Output 209	Analog	15.00	One Hour	11:32:50

  

Point No	Point Name	Point Type	Value	Override	Time
209	Anl Output 209	Analog	15.00	Continuous	11:33:18

Point No	Point Name	Point Type	Value	Override	Time
209	Anl Output 209	Analog	0.00		11:31:39

The point’s **Strategy** module has a digital output labeled **Override**, which is set to a value of **1** if an override is in effect (i.e. the hardware point is ‘disabled’), or **0** if the point is not overridden (i.e. the point is ‘enabled’).

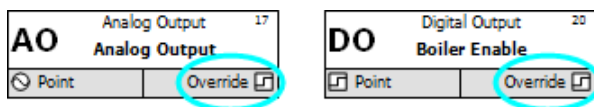

## USING THE OVERRIDE POINT DIALOG:

To open the **Override Point** dialog, either:

1. Right-click on a line or module and select **Override Hardware Point Value** from the context menu:

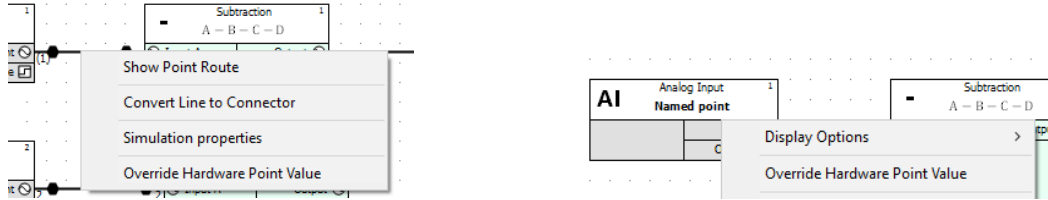

2. or click on the **Override** button in the **Livelog** dialog

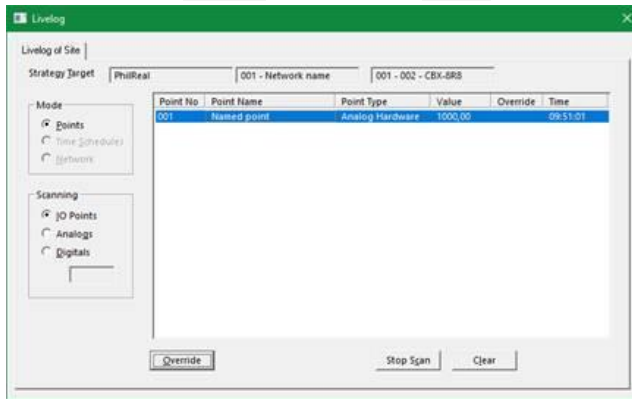

The relevant **Override Hardware Point** dialog (analog or digital) will open:

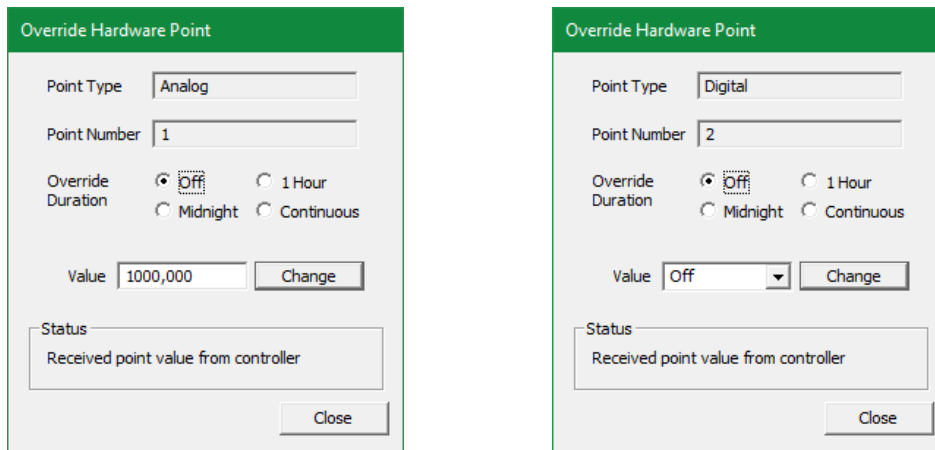

The **Override Duration** can be set to one of the following states:

- inactive at all times - **Off**
- active until the controller time passes **00:00** - **Midnight**
- active for one hour from the time at which it becomes active - **1 Hour**
- active at all times – **Continuous**
- If the override is caused by a Controller’s HOA switch, the override state is reported as **“HOA”**

The **'Midnight'** and **'1 hour'** options are provided to conveniently avoid problems that could arise if the override is not removed when it is no longer required.

**Note:** Even if 'off' is selected in the **Override Duration** for **Hardware Point** section, setting a value (analog) or state (digital) for the point will still have an effect. When the **Override** button on the dialog is pressed, the value is sent to the point in the controller strategy, which stays at that value until the next time that the controller scans its strategy.

Enter a value for the point.

In this instance, a value of **100** is being entered for an analog point.

A value of **Off** or **On** can be entered for digital points.

Select the length of time that the value of the point will be changed in the **Override Duration for Hardware Point** section of the dialog.

The point will be set to the entered value when the **Change** button is pressed:

Click the **Close** button to close the dialog.

### Notes about overriding BACnet points

#### Inputs

When an input is overridden via CXpro<sup>HD</sup>, both the “out of service” and the “override” flags are automatically set.

When an overridden input comes out of its CXpro<sup>HD</sup> override both the “out of service” and the “override” flags are reset. It will be put into service regardless of the state it was in prior to going into override.

To override an input via BACnet, the “out of service” flag is manually set by writing to the “out of service” property. Then the desired value is written to the present-value. The OWS can clear any CXpro<sup>HD</sup> override by putting the point back into service and then back out again. From CXpro<sup>HD</sup> side, the “override” flag will disappear and be replaced with an “overridden” flag.

Putting an input in service will clear all overrides both CXpro<sup>HD</sup> and BACnet and will flag the change appropriately on both protocols.

#### Outputs

When an output is overridden via CXpro<sup>HD</sup>, both the “out of service” and the “override” flags are set. The information in the present-value property will still be delivered to the hardware layer despite being out of service.

When an overridden output comes out of its CXpro<sup>HD</sup> override, the point is put back in service, and both the “out of service” and the “override” flags are reset.

To override an output via BACnet, it is presumed that the priority array will be used, and clear all overrides and flag the change appropriately on both sides.

All I/O blocks have an output labeled **Override**. This output is true any time the point is “out of service” or “overridden” via CXpro<sup>HD</sup>. This way the point reflects the status of the data regardless of whether it is being overridden via BACnet or CXpro<sup>HD</sup>.



## HOW TO ENABLE A HARDWARE POINT VALUE (REMOVE MANUAL OVERRIDE STATUS)

Removing manual override status from a hardware point (enabling) means that the point will once again respond to hardware connections or strategy conditions.

If the override duration on a hardware point has been set to **1 hour** or until **Midnight** the point will be enabled when the specified period has elapsed. However,

- If the override is identified as “HOA” you must use the switch on the Controller to disable it.
- if the override duration has been set to **Continuous** the following procedure must be carried to enable the point:

Open the **Override Point** dialog by selecting **Change Point** from the **Controller** tab of the **Ribbon** or by clicking on the **Override** button in the **LiveLog** dialog, and select the point to be overridden.

Select the **Off** option in the **Override Duration** section of the dialog,

Click the **Change** button to apply the change.

Click the **Close** button to close the dialog.



If you opened the **Override** dialog from the **LiveLog** dialog, then to see the new value of the point, click the **Restart** button.

The next time the **LiveLog** scans that point, its new value will be displayed. The **LiveLog** window displays the symbol ¶ beside the value of points that have been changed.

**Note:** Double-clicking a point number in the **LiveLog** window places an asterisk beside it allowing it to be monitored more effectively.

## HOW TO CHANGE THE VALUE OF A SETPOINT

The value of a set point can be changed using the **Change Set Point Value** dialog box, in a similar way to changing the value of a hardware point.

The procedure for changing the value of a setpoint is as follows:

To open the **Change Set Point Value** dialog either:

1. Right-click on a setpoint module or the line and click **Change Setpoint Value** option from the context menu:

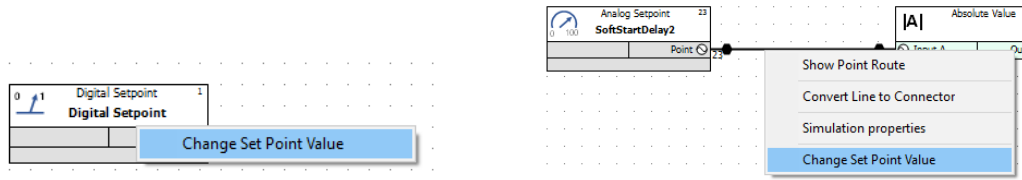

2. or click on the **Override** button in the **LiveLog** dialog:

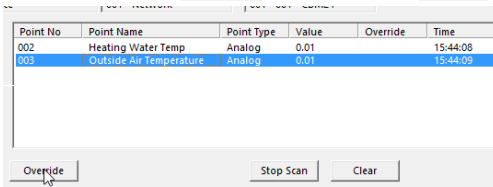

The relevant **Change Set Point Value** dialog (analog or digital) will open:

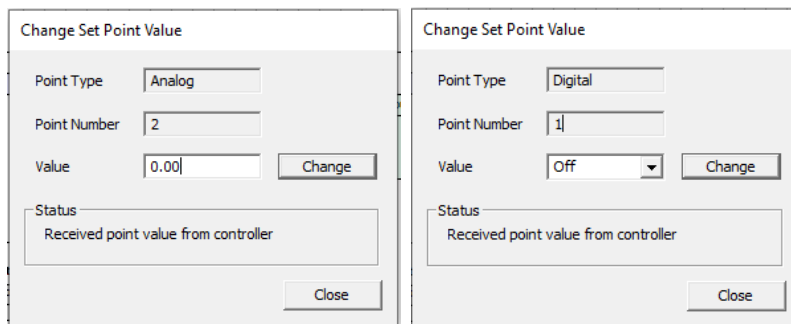

Enter a value for the point.

In this instance, a value of **100** is being entered for an analog point.

A value of **Off** or **On** can be entered for digital points.

The point will be set to the entered value when the **Change** button is pressed:

Click the **Close** button to close the dialog.

If you opened the **Override** dialog from the **LiveLog** dialog, then to see the new value of the point, click the **Restart** button.

The next time the **LiveLog** scans that point, its new value will be displayed. The **LiveLog** displays the symbol ¶ beside the value of points that have been changed.

**Note:** Double-clicking a point number in the **LiveLog** window places an asterisk beside it allowing it to be monitored more effectively.

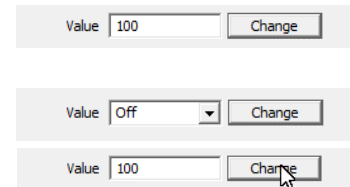

## MANUALLY CHANGING A MULTI-STATE VALUE

As a tool to test a strategy, it is possible to manually set the value of one of the priorities in a Multi-state Value's priority-array when connected to the site.

- This is intended for testing only, and must be manually reversed when no longer required.
- The **Multi State Value** module must be on the running strategy to change the value this way.

To change a Multi-state Value (MV):

Right-click on a **Multi State Value** module and select **Change Multi State Value** from the context menu.

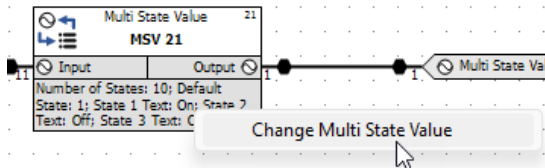

This will open the **Change Multi State Value** dialog:

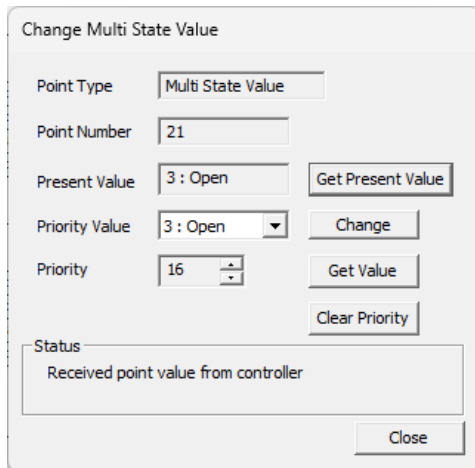

Select one of the configured State Texts from the **Value** dropdown menu and specify a Priority to read from / write to the priority-array property of the MV object.

To read the current value at the selected priority from the MV object, click the **Get Value** button.

To change the value at the selected priority to the specified value, click the **Change** button

To write **NULL** to the selected priority (i.e. to clear the current value) click the **Clear** button.

The **Get Present Value** button will read the present-value property and the current highest priority of the MV object.

## 6 Creating Strategies

### WHAT IS A STRATEGY?

An **ABB Cylon**<sup>®</sup> Field Controller interacts with HVAC and other equipment by varying its outputs in response to inputs such as temperature, switch settings, air flow speed, etc.

The way that the controller’s outputs react in response to the controller’s inputs can be defined by the user. The definition is called a ‘strategy’.

A strategy is the ‘user program’, stored in an **ABB Cylon**<sup>®</sup> Field Controller, which configures the controller for a specific role in a BMS site. It can be described as the “implementation of a solution to a requirement on a site”.

In **CXpro<sup>HD</sup>**, a strategy is designed graphically using the algorithmic modules available on the **modules** panel. It is saved as a strategy file on the Engineering PC and then downloaded to the controller for which it was designed, where it tells the controller how to behave within the BMS site.

The simplest of strategies is made up of algorithmic modules, hardware, and virtual points. Strategies are often more complex, however, and can also include time schedules, trendlogs, and alarms.

### AN EXAMPLE OF A STRATEGY

#### The Problem

The heating system of a building is too costly to run constantly.

#### The Solution

The heating system should be switched off when the outside air temperature rises above a certain point (for example 23°C). It should not be switched on again until the outside air temperature drops below another pre-defined point (in this case, 18°C).

#### The Strategy

A strategy to implement this solution to the problem can be designed in **CXpro<sup>HD</sup>** and downloaded to the controller connected to the heating system, where it will be applied.

The strategy shown below uses the **Hysteresis** module to compare the outside air temperature to the two set points defined in the module (in this case, these are set at 18 °C and 23 °C). If the outside air temperature is greater than 23 °C, the H output is unset (**off**). If it is less than 18 °C, the H output is set (**on**).

The strategy is saved and then downloaded to the **Field Controller** connected to the heating system.

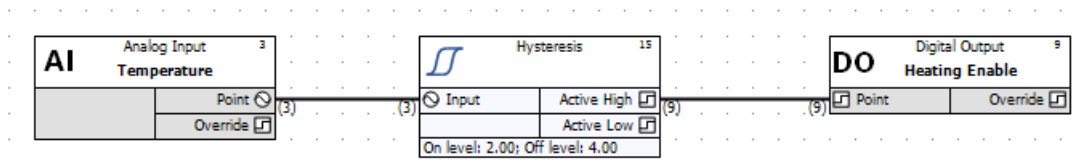

## HOW TO CREATE A STRATEGY

To create a strategy, follow these steps:

- Select Site, BACnet Router, and Field Controller in the **Site List** and double-click to open its strategy:

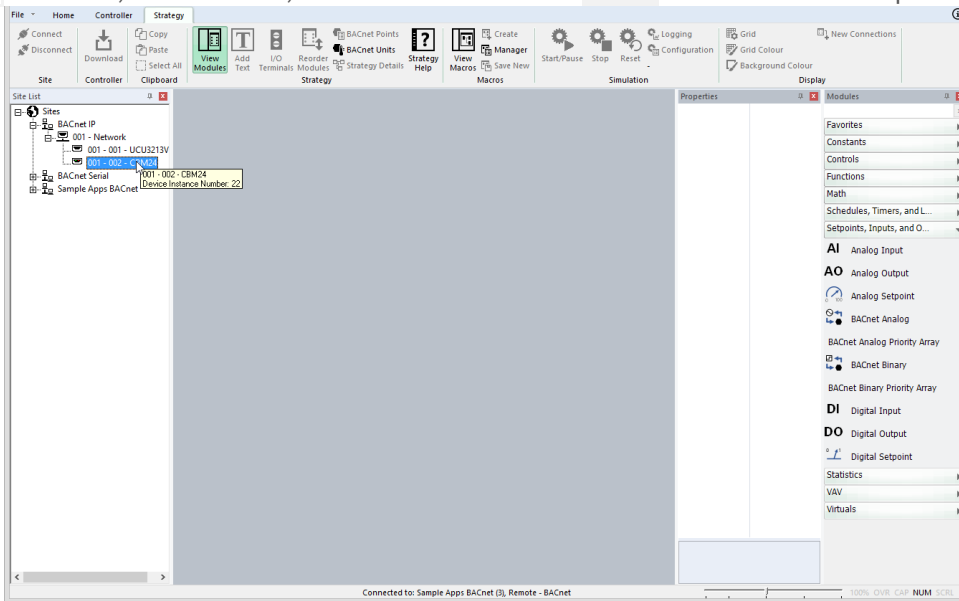

- If the selected Field Controller does not already have a strategy, you will be prompted to create a new one:

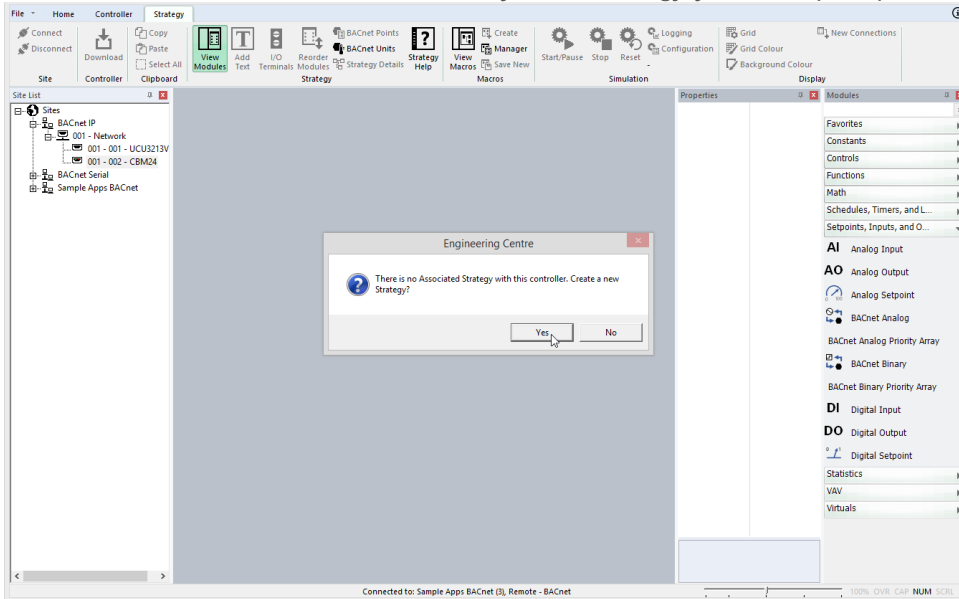

- Click **Ok** to open a blank strategy

- Select a module from the modules panel

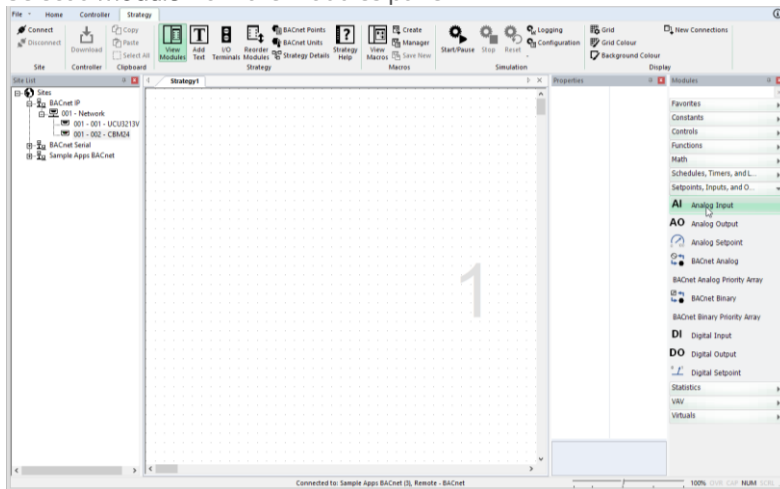

- and place it on the drawing area

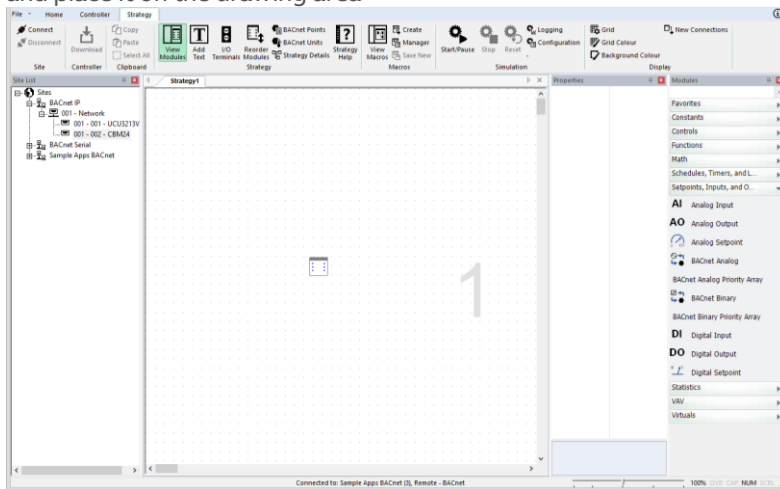

- If the module represents a point you will be prompted to enter a name. Enter one and click **Ok**.

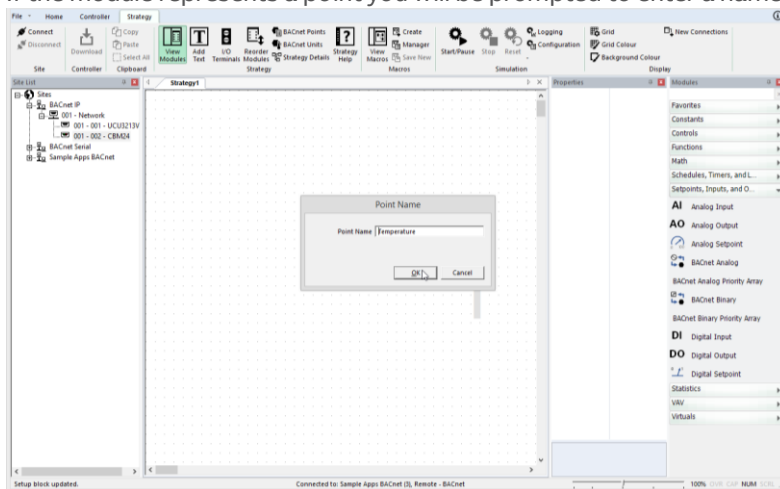

The module is now on the drawing area. It can now be moved, deleted, copied, or linked to other modules.

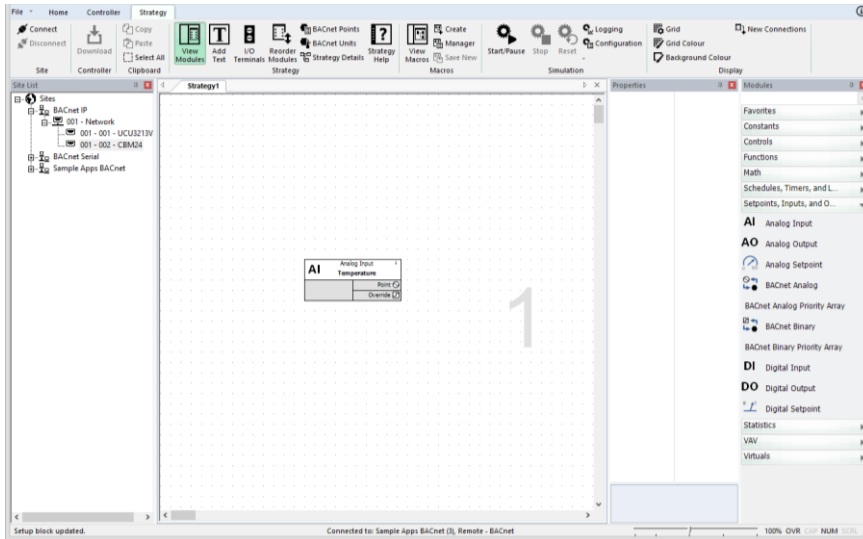

To operate on a module, it must be selected by left-clicking on it,

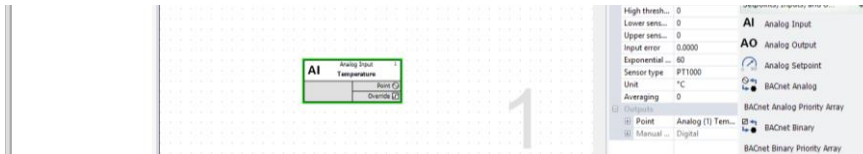

or by dragging a selection box around the module symbol (or symbols)

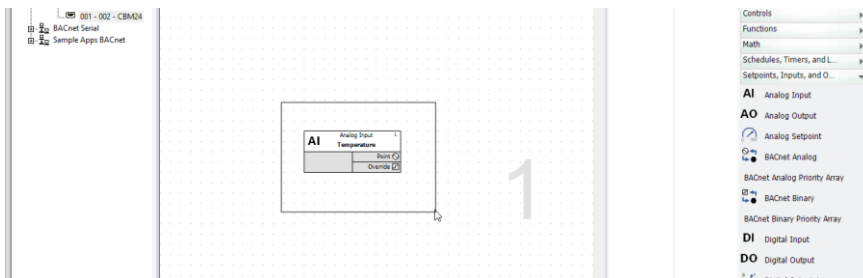

Once a module has been selected, it can then be:

- move d by using the mouse to drag the module to its new location;
- delet ed by pressing the **[DELETE]** key on the keyboard;
- cut by pressing **[Ctrl] + [x]** on the keyboard
- copie d by pressing **[Ctrl] + [c]** on the keyboard
- paste d by pressing **[Ctrl] + [v]** on the keyboard

**Note:** Pasted hardware point modules may adapt some parameters to the destination point but retain others. For example, an analog input configured as PT1000 when pasted to a UniPut™ will change to a voltage input but retain the max and min limits (in the Advanced button) which for PT1000 could be min 0 and max 0, leading to incorrect operation of the UniPut™.

## PLACE ALL THE REQUIRED MODULES ON THE DRAWING AREA AND JOIN THEM

Place other modules required to implement the strategy on the drawing area.

Modules must be positioned from left to right on the drawing area. Hardware inputs must go on the left side of the drawing area, hardware outputs on the right. Between the inputs and the outputs, organize the modules so that a signal flows from left to right across the strategy.

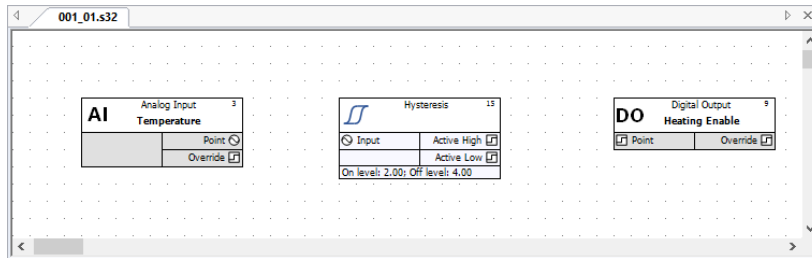

Join the modules together as required, by placing the mouse pointer over module inputs or outputs

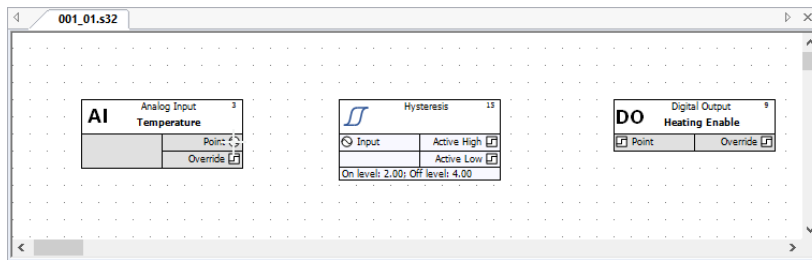

and dragging to another modules output or input.

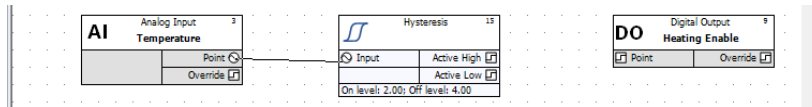

CXpro<sup>HD</sup> displays lines between linked modules:

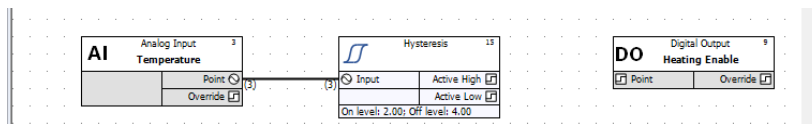

If you cannot see a line connecting the two modules, right-click on the drawing area and select Display Options > Display Lines > Show All Lines from the menu that appears

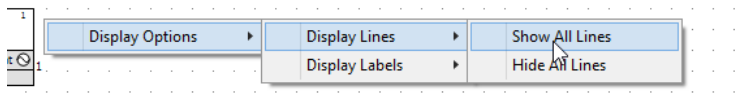

Continue joining modules until all the required connections have been made.

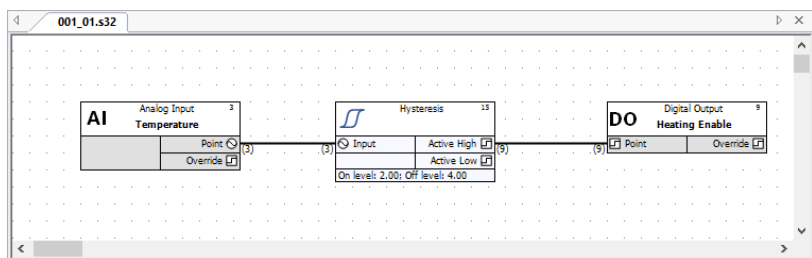



### Automatic point selection

When two unconnected modules are linked together, CXpro<sup>HD</sup> automatically selects the next available virtual point. This is the lowest numbered unused point. This number is entered in the two modules that are linked, as an input and an output, and it is also displayed at either end of the connecting line. In the example below, the number of the virtual point connecting the two modules is 1 and it is displayed at both ends of the connection:

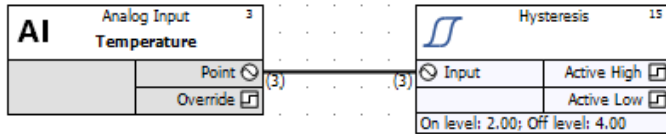

If you cannot see the point number at either end of a connection line, click **Module Setup** from the **Display** menu. right-click on the drawing area and select **Display Options > Display Labels > Show Number** from the menu that appears

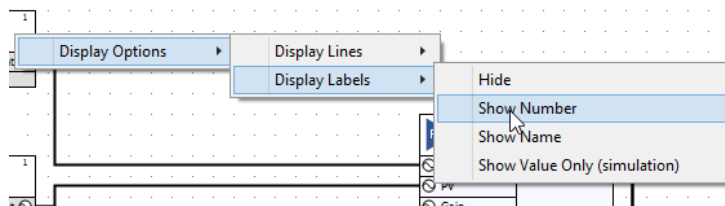

When the output of a module which is already connected is connected to the input of another module, the point number of this output will be written in the input.

### Selecting a connection line

To select a line connecting two modules, click the line with the left mouse button. Selected lines are displayed with a green highlight. Selected lines can then be:

- moved by using the mouse to drag the line to its new location
- deleted by pressing the **[Delete]** key on the keyboard

When a connection line is deleted, the point number in the input of the target module will be removed.

If this connection was the only one for the output of the source module, the point number will be removed from there too. The point will now be available for other connections.

### Naming a point

To give a point a name, select it and then edit the text in the **Name** property on the **Properties** pane.

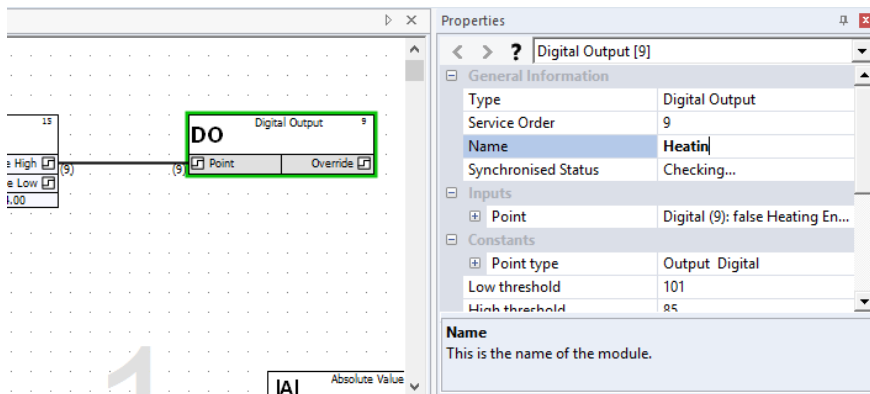

When finished, press enter and the name will be displayed on the module in the Drawing Area.

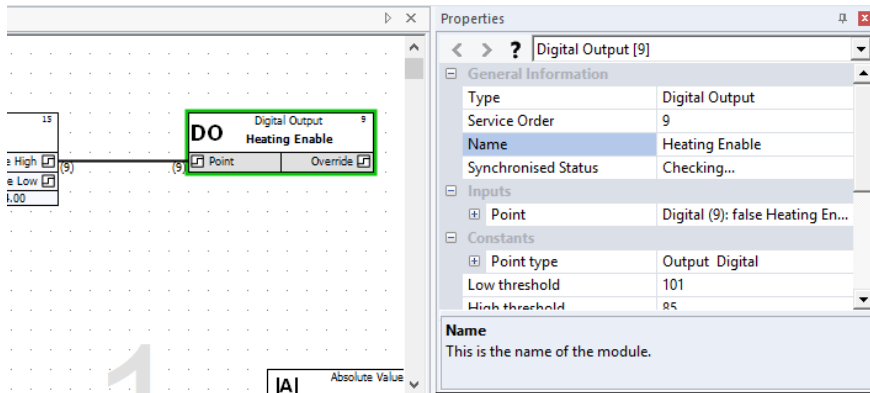

The name can have no more than 24 alphanumeric characters. Spaces, commas, and full stops may also be used. Each point in a controller must have a point name that is unique in that controller.

### Assigning a unit to a point

In the case of Analog points, the **Units** list box (which is displayed in **Properties** pane) contains a collection of text strings, one of which will be displayed together with the point value.

To specify a type of unit for a point, select the line that represents it, and select a value from the **Unit** list.

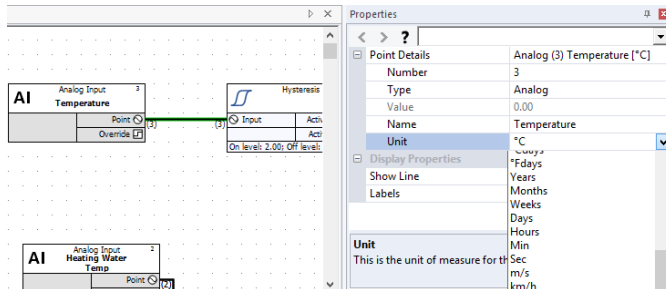

If the point is a digital point, select the required unit in the **Low Unit** and **High Unit** list boxes. The units of a digital point are text strings, which are displayed instead of the digital values 0 or 1.

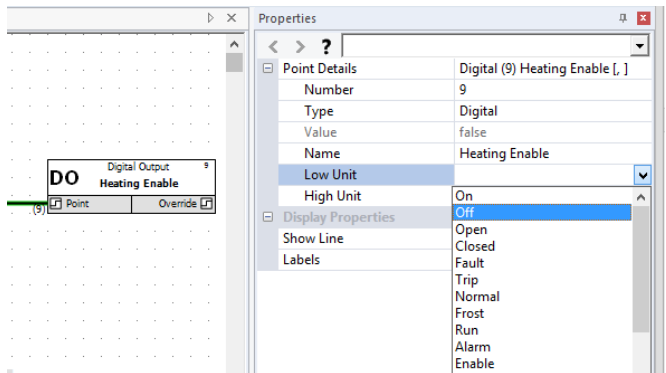

If the list does not contain the unit you require, additional application-specific units can be entered manually in the `C:\CXproHD\ (SITENAME) \SYSTEM \site.ini` file. For details on how this is done, see *Appendix :: Adding units of measurement to the system* on page 205.

Additional units of measurement can also be added if points are defined using the shortcut method (see *A short cut to defining hardware points* on page 78). When the tab (or comma) separated list of point definitions is prepared, units of measurement which are not already defined in `C:\CXproHD\ (SITENAME) \SYSTEM \site.ini` can be used. When the definitions are pasted to the **Database Interface**, the new units of measurements will be added automatically to `site.ini`.

## CREATING STRATEGIES - SET THE VALUES OF THE MODULE'S CONSTANTS

Many modules can be configured by setting internal constant values. These are accessible in the Properties pane when the module is selected. For example, the **Timer with Constant Inputs** module has the following properties:

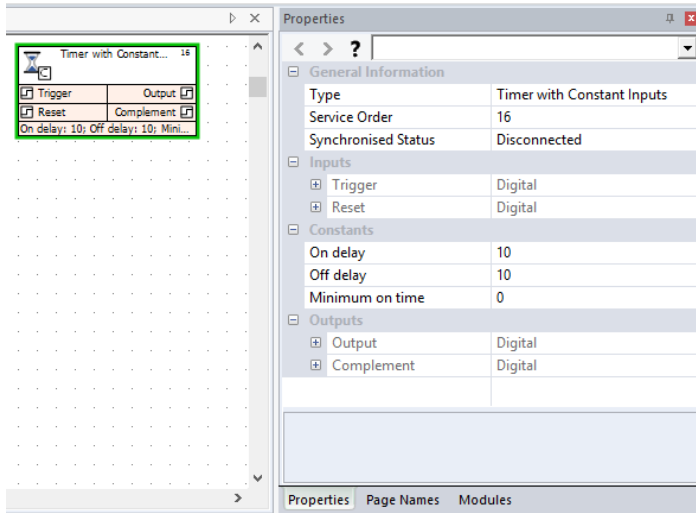

## CREATING STRATEGIES - ADD EXPLANATORY TEXT IF NECESSARY

Text can be added to the drawing area to label parts of the strategy to explain the purpose of certain modules, or groups of modules, within the strategy,

You can add text or edit text that is already in the strategy drawing. You can also delete, cut, or copy the text in a strategy.

For details see *How to add text to a strategy* on page 68

## HOW TO REORDER BLOCKS IN A STRATEGY

It is possible to change the order of blocks within a strategy, which can help to optimize the servicing process.

From the **Site List**, right-click on the controller and select **Strategy Operations > Re-Order Module Blocks**

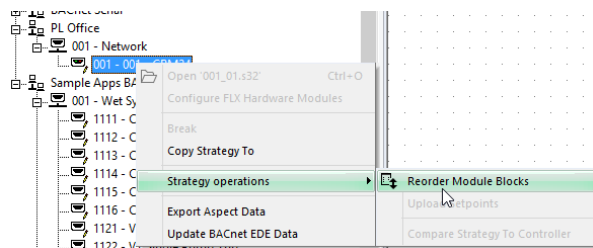



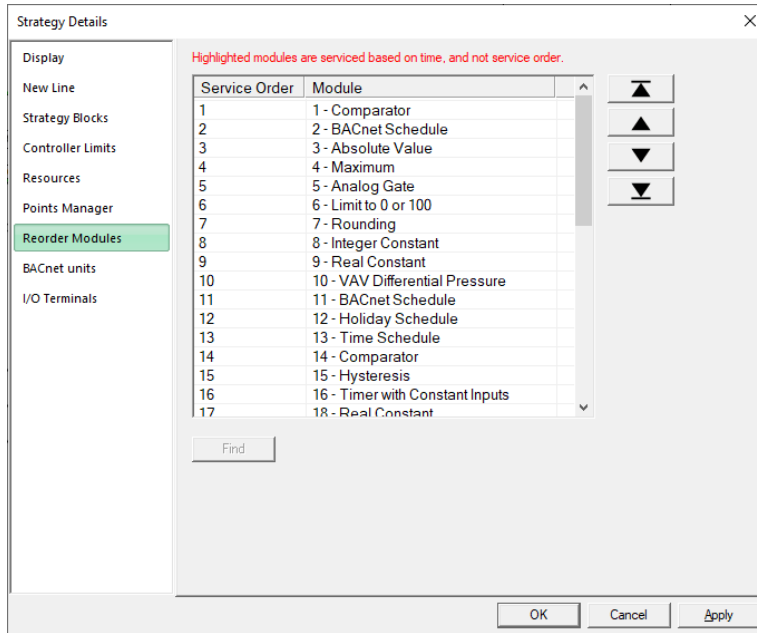

This opens the **Reorder Modules** tab in the **Strategy Details** dialog:



The list shows modules in their Service Order.

**Note:** Some modules serviced based on a time schedule, not necessarily according to their Service Order. Any modules in the list that are in this category will be highlighted.

Select a module in the list and use the buttons on the right-hand side of the dialog to change its position in the list:

-  Move the highlighted block to the top of the list (Service number = 1)
-  Move the highlighted block up one position in the list
-  Move the highlighted block down one position in the list
-  Move the highlighted block to the bottom of the list
-  Highlight the selected block in the strategy drawing.

Repeat until the list is in the required order.

## HOW TO UPLOAD SETPOINT VALUES

It is possible for all of the controller values for all setpoints in a single strategy to be retrieved in a single operation.

From the Site List, right-click on the controller and select **Strategy Operations > Upload Setpoints**

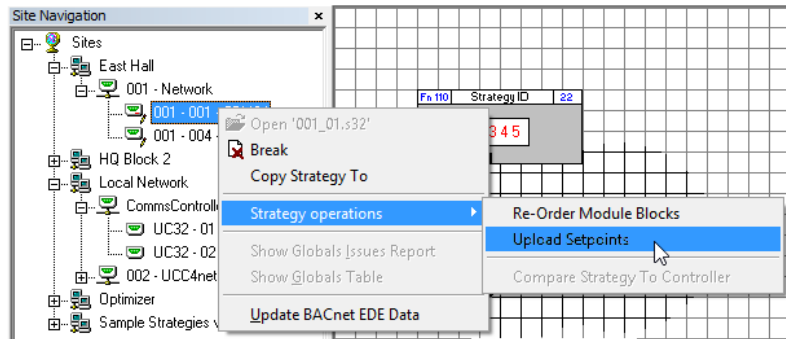

This opens the Upload Setpoints dialog:

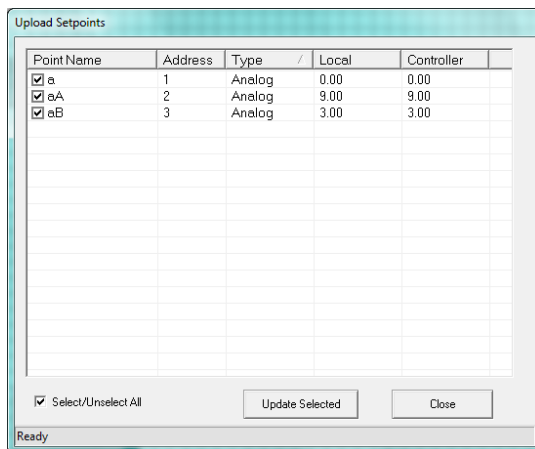

Select the points to be uploaded and click the **Update Selected** button

## NAMING STRATEGY FILES

When saving strategy files, it is recommended that you use a name which indicates the site, the BACnet Router number, and the Field Controller number.

For example, the strategy for the Air Handling Unit controller, which is Field Controller number 1 on the Rooftop subnet (which is BACnet Router number 1) on the Office Block site might be named `Office_001-01 AHU . STG`

## HOW TO OPEN AN EXISTING STRATEGY:

A strategy file can only be opened if it is Associated with a controller.

You can open a controller's Associated strategy in one of the following ways:

1. Double-click on the controller in the Site Tree

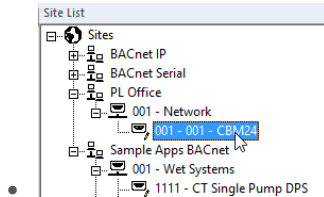

3. Right-click on the controller in the Site Tree, and select the filename

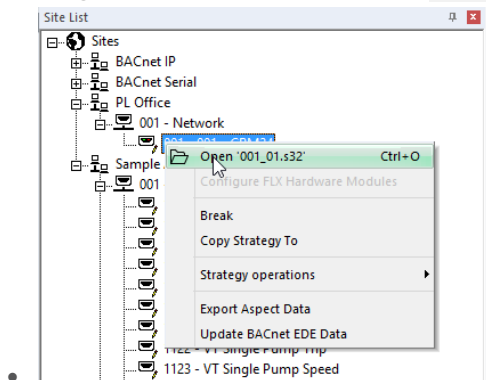

4. Select the controller in the Site Tree, and select Open from the File drop-down

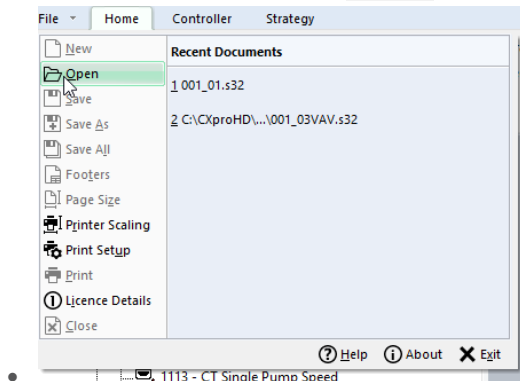

**Note:** If the strategy for the selected controller is already opened, all of these options will be disabled (greyed-out).

**Note:** If you want to open a different strategy file for a controller you must first remove the existing association, then associate the controller with the required strategy.

## STRATEGY ASSOCIATIONS

### WHAT IS AN "ASSOCIATED" STRATEGY?

Each of the Field Controllers in the **Site List** can have a strategy drawing file 'associated' with it, which means that CXpro<sup>HD</sup> is aware of the filename of the strategy corresponding to that Field Controller. When a **Field Controller** is selected, its associated strategy can be opened by double-clicking, or by selecting from the right-click menu.

The icon representing the field controller changes when the strategy file is associated with it.

The relationships between controllers and strategy filenames for a particular site are stored in the file

```
C:\CXproHD\[siteFolderName]\SYSTEM\associations.xml
```

**Note:** CBXi controllers at the 'network' level can also have strategies associated with them.

## CREATING ASSOCIATIONS

### New strategies

When a new strategy drawing is created, a target controller must be selected. When that strategy is saved for the first time, it is associated with the selected target controller.

### Existing strategies - manual

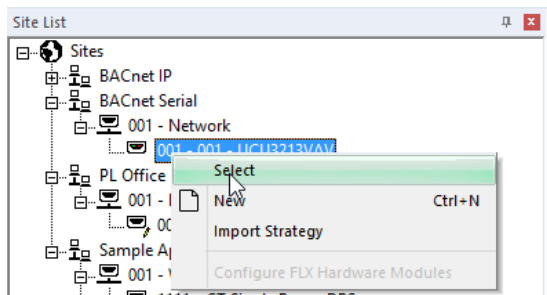

A strategy can be associated with a field controller by right-clicking on the Field Controller and selecting "Select". A list of all existing strategy files that are eligible to be associated with the selected controller will be displayed.

## BREAKING ASSOCIATIONS

Associations can be broken using a toolbar or right-clicked popup menu option; the link between the Site Tree Field Controller and the strategy drawing is removed.

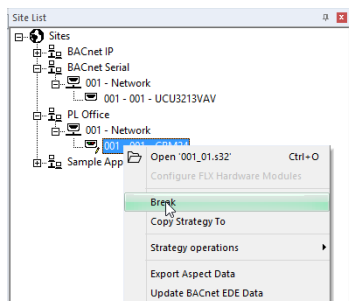

If an association is broken for an opened strategy drawing, then the strategy drawing will be closed and the user will be prompted to save it if changes have been made. Breaking an Association allows the User to associate a different strategy drawing to the Field Controller, using a toolbar or right-click popup menu option on the **Site Tree** Field Controller.



## COPYING ASSOCIATED STRATEGIES

From the **Site List**, it is possible in a single operation to create a copy of the strategy associated with any Field Controller node and associate that copy with another Field Controller node, as long as the target is of a compatible controller type and does not already have a strategy associated with it.

**Note:** A strategy **cannot** be copied if it is open and has been modified but not saved (the user is prompted to save the strategy so that the strategy can be copied).

To copy a strategy in the **Site List** interface:

1. Right-click on the source Field Controller node – i.e. the controller to which the existing strategy is associated.

2. In the pop-up menu, select **Copy Strategy To**

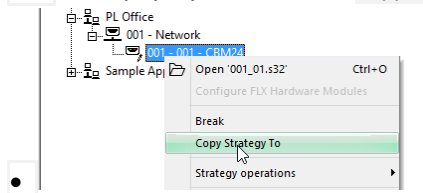

3. In the **Copy Strategy** dialog that appears, click on the Field Controller to which you want the copied strategy to be associated

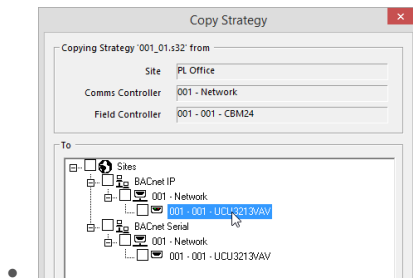

The **Copy Strategy** dialog displays the source Site, BACnet Router, and Field Controller node details as well as the strategy that will be copied.

The **To** box contains a "tree" list of potential target Field Controllers, grouped by Site. Potential target Field Controllers are those that:

- are of a Controller Type that is compatible with the source Field Controller Node
- do not already have an Associated strategy
- do not have a newly created Strategy

The next available Field Controller node is always selected on the source Site. If no Field Controllers are available on the source Site then no Field Controller is selected and the **Site Tree** is shown collapsed (closed).

The **Copy** button is enabled when a Field Controller Node is selected. When it is clicked, a new strategy is created and opened with the contents of the source strategy being copied, including the Database names and Keypad Details. The copied strategy is then Associated with the Target Field Controller node.

## IMPORTING A STRATEGY

The **Copy Strategy To** function applies to strategy files that reside in the current Site file structure. It is possible that files which were associated with a specific folder have been copied to locations outside the Site folders, and will not be found by the **Copy Strategy To** process. In that case, the **Import Strategy** function may be used.

To Import a strategy in the **Site List** interface:

1. Right-click on the target Field Controller node

The target Field Controller is the controller to which the Imported strategy will be associated.

2. In the pop-up menu, select **Import Strategy**.

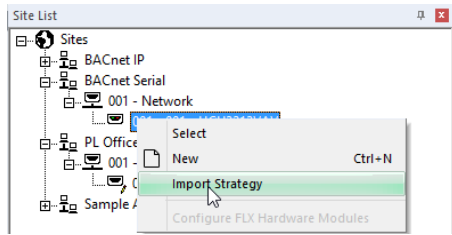

The system will scan for suitable strategies for import

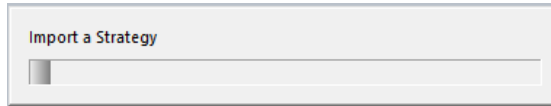

And display a list of the results.

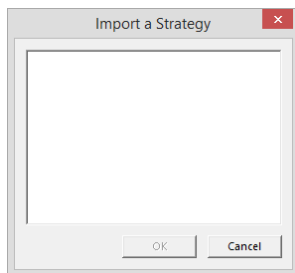

- Note:** It is possible that the list will be blank because a strategy file will only be listed if:
- a. It does **not** reside in the current site.
  - b. It has the correct embedded site, BACnet Router address, and field controller address.
  - c. It is not already associated with any controller.

You cannot for example import a strategy from controller number 006 on BACnet Router 5 on a remote site onto controller number 005 on BACnet Router 5 on the local site. Neither can you for example import a strategy from controller number 006 on BACnet Router 5 on a remote site onto controller number 006 on BACnet Router 2 on the local site.

i.e. The file to be imported must have originated on the same controller on the same site.

3. Select a strategy file and click **OK**. The strategy will be copied to the current site, and the copy will be associated with the selected controller.

## OPENING MULTIPLE STRATEGIES

CXpro<sup>HD</sup> allows you to have several strategies open at once. Each strategy must be opened individually as described above. Each strategy can be minimized, maximized, and arranged in a number of ways in relation to the other open strategies.

## DOWNLOADING A STRATEGY

When you have created a strategy in CXpro<sup>HD</sup>, you must download it from CXpro<sup>HD</sup> to the targeted controller before it will function.

**Note:** When downloading a strategy to a controller, CXpro<sup>HD</sup> automatically wipes the controller’s memory and sends set-up.

All downloads currently require a cycle of outputs, but by using this feature with certain modules, you can change constants and get around the outputs issue

**Note:** The targeted controller should not be powered down for at least 40 seconds after a strategy write has been initiated by any of the methods below.

To download a strategy to the targeted controller:

3. Open the strategy and connect to the controller
4. Download the strategy

**Note:** When you download a strategy to a BACnet controller from CXpro<sup>HD</sup>, any configuration that has been set by a separate B-OWS – e.g. an Alarm Recipients list – will be **wiped**. You must re-download the Alarm Recipients list, and any other B-OWS specific configuration after the strategy download is complete.

**Note:** Downloads generally require outputs to cycle, but in v1.04 and later, certain modules have a feature to change constants without this cycling.

In these modules a button is available at the top of the modules panel to download any changes to the highlighted constants parameters, without cycling the controller outputs:

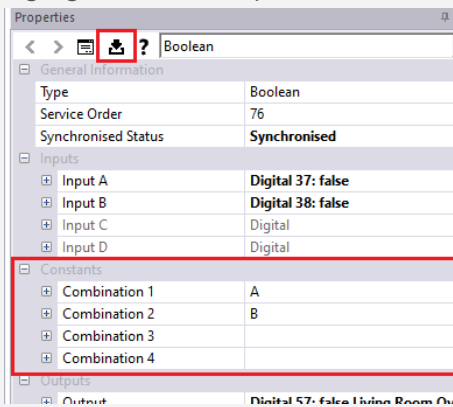

**Note:** Download of constants will only be possible when all other module parameters are synchronized between the strategy and controller.

The following modules may have their constants downloaded at run-time without causing a cycle of the controller outputs:

- Hysteresis
- Tuneable Hysteresis
- Enthalpy
- Boolean
- Forward PID
- Reverse PID
- Tuneable Forward PID
- Tuneable Reverse PID
- Real Constant
- Integer Constant
- Digital Extract
- Time Proportional Driver
- Raise Lower Driver
- Digital Constant
- Long Timer
- Minimum Off Timer
- Holiday Schedule
- Make Linear
- HX-Diagram
- Runtime
- Damping
- Rounding
- Control Changeover
- BACnet Accumulator
- Trigonometric Math
- Cooling Optimizer A
- Heating Optimizer A
- Heating Optimizer B
- Deadband Variable
- CBT Stat
- Custom PID
- VAV Actuator
- VAV Flow Calculation
- Analog Multiplexer
- Timer with Constant Inputs
- Digital Multiplexer
- Bitwise Logic
- Duty Standby
- Analog Select
- Out Of Range
- Equation
- Staging
- Meter
- Alarm

### Open the strategy and connect to the controller

Select the target controller in the Site List and open its associated strategy by double-clicking or selecting **Open** from the **File** menu or right-click menu.

Connect to the controller by clicking on the **Connect** button in the **Home** tab of the **Ribbon**:

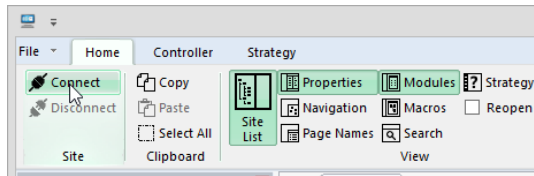

### Download the strategy

Download the strategy to the targeted controller by clicking on **Download** in the **Controller** tab of the **Ribbon**

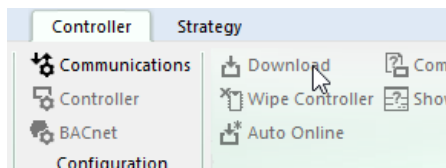

When you use Automatic Download, CXpro<sup>HD</sup> automatically deletes all previous points and strategies from the controller as these could conflict with the strategy being downloaded. It then downloads the strategy and sends the set-up (i.e. it informs the controller of the number of blocks it must service in the strategy).

While this is happening, the **Downloading** window is displayed.

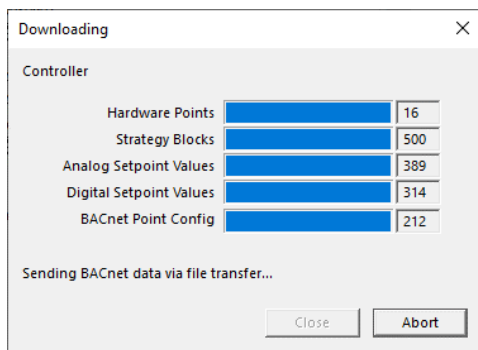

The progress bar at the top of the **downloading** window shows the progress of the download, while the status box (at the bottom of the window) tells which of the three stages in the download process (wiping the memory, downloading the strategy or sending the set-up) CXpro<sup>HD</sup> is currently completing.

The **Downloading** window also includes a **Complete** box, which displays the number of the block of the strategy, analog point or digital point that is currently being downloaded. In the above example, the progress bar shows that the download is 79% complete, the complete box tells us that CXpro<sup>HD</sup> is downloading block number 251 of the strategy and the status box tells us that CXpro<sup>HD</sup> is busy downloading the strategy to the controller.

### Wipe the controller's memory

Wipe the controller's memory by choosing **Wipe Controller** from the **Controller** tab on the **Ribbon**.

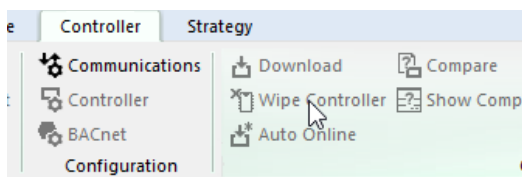

This opens the **Wipe Controller** dialog box, allowing you to choose individual parts of the controller memory to be wiped

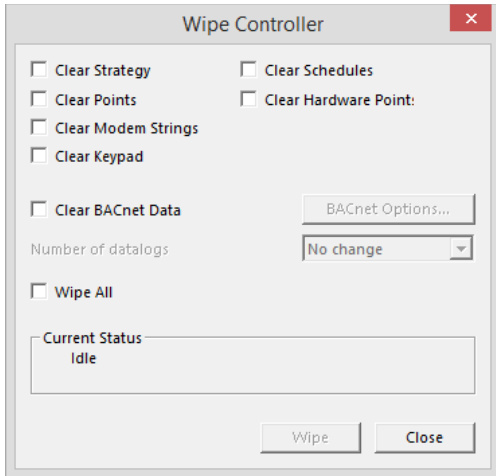

Click **Wipe** to close the **Wipe Controller** box.

CXpro<sup>HD</sup> will display a message to confirm that the controller's memory has been wiped. Click **OK** to close the message box.

### How to check the controller type to which you are downloading

To find the type of the controller to which you are downloading, open the **Strategy Details** dialog by clicking on **Strategy Details** in the **Strategy** tab of the **Ribbon**

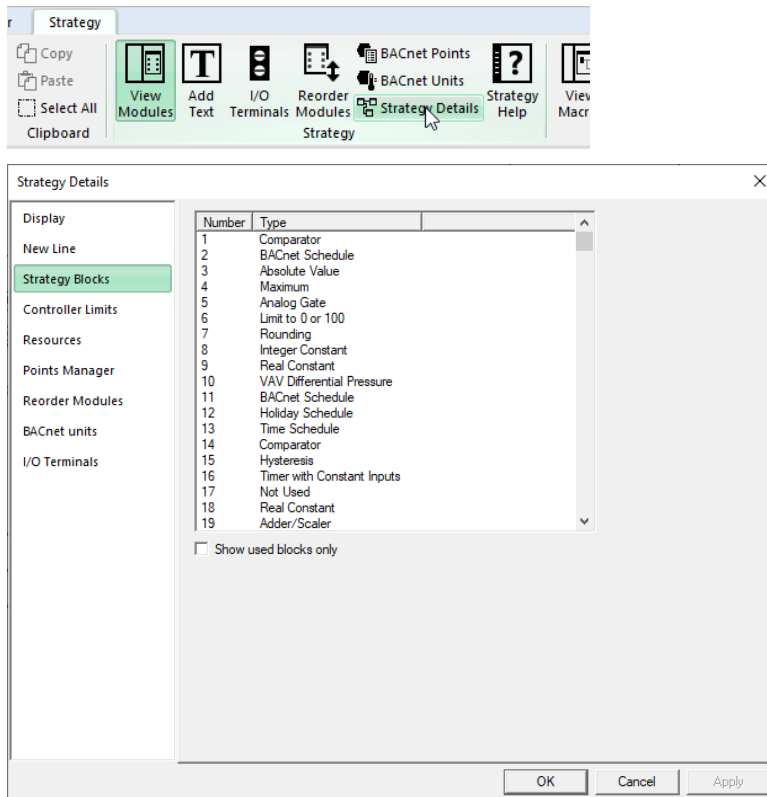

Click the **Controller Limits** tab.

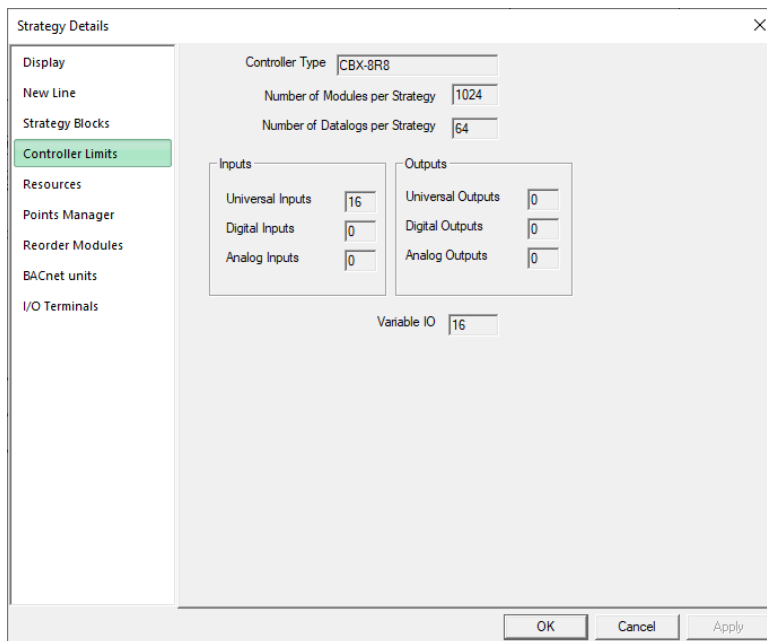

In the example shown, the **Controller Type** box shows that the selected controller is a **CBX-8R8** controller.

### Edit the strategy

Edit the strategy by placing and joining the required modules on the drawing area and editing their values and units.

### Download the strategy

When you have completed the strategy, you must then download it.

Connect to the controller by clicking on the **Connect** button in the **Home** tab of the **Ribbon**:

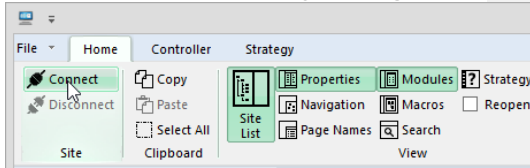

Download the strategy to the targeted controller by clicking on **Download** in the **Controller** tab of the **Ribbon**

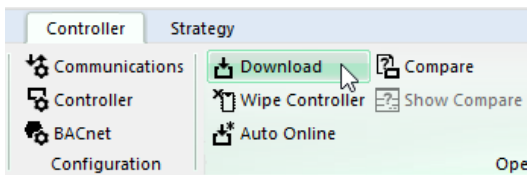

A warning is displayed:

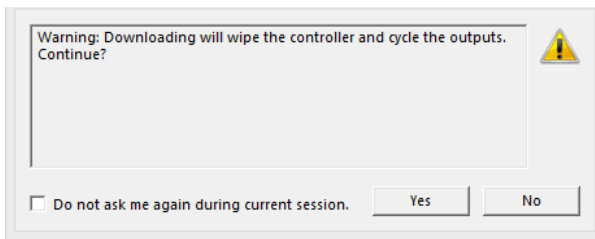

The **Downloading** window will appear, to display the progress of the download.

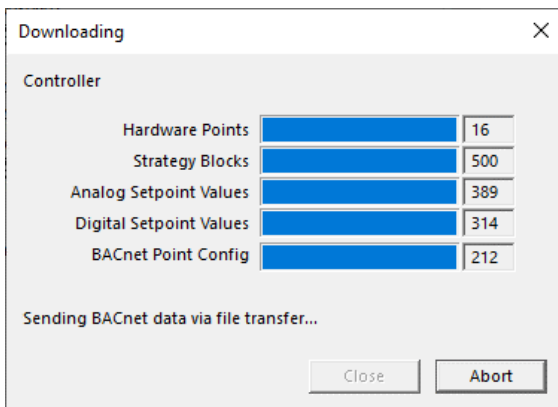

When CXpro<sup>HD</sup> has downloaded all the blocks that you specified, it will automatically close.

## STARTING A STRATEGY (SENDING THE SETUP)

When the memory of a Field Controller has been wiped and the strategy has been downloaded to it, the Controller must be told how many blocks are to be serviced. This is called the Setup of the strategy. Sending Setup is also referred to as **starting the strategy**. If you are using Automatic download, CXpro<sup>HD</sup> sends the Setup automatically when you download a strategy to the controller. Otherwise, you must send the Setup as described below.

Select the Controller in the Site Tree, and connect to it by clicking on the Connect button in the Controller tab of the Ribbon

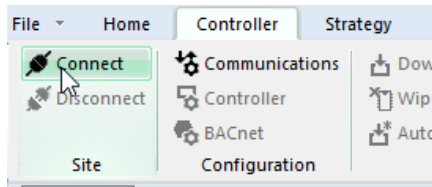

Open the Controller Configuration dialog by clicking on Controller in the Controller tab of the Ribbon

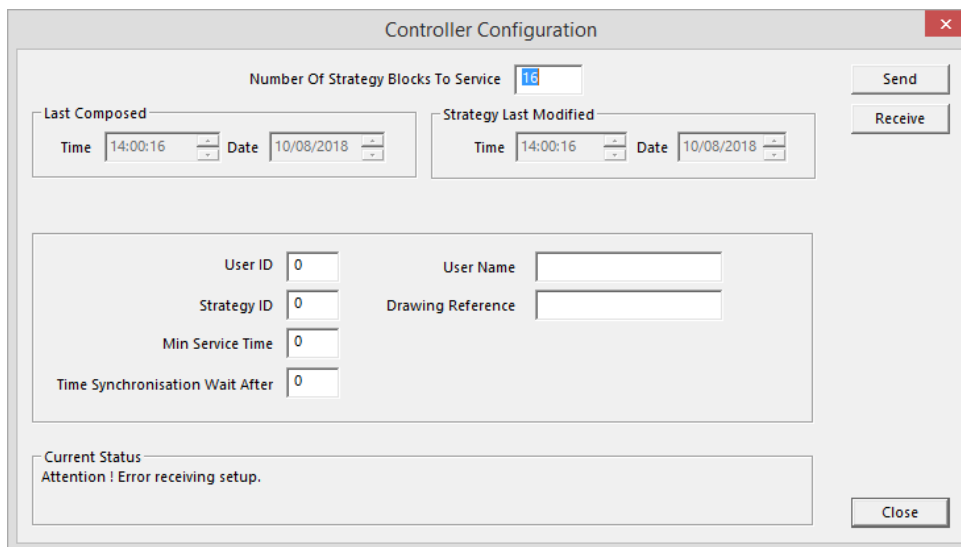
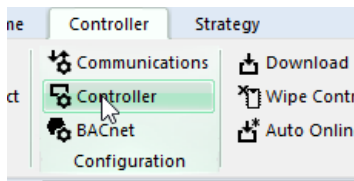

The number in the **Number of Strategy Blocks To Service** box,  $x$  (which is automatically entered by CXpro<sup>HD</sup> but can be changed by the user), activates the first  $x$  blocks of the strategy in the Field Controller. This number,  $x$ , must be greater than or equal to the number of the highest numbered block used by the strategy. Otherwise, the parts of the strategy which occupy blocks with a higher number will not be serviced, and their point values will not be updated, which may cause the strategy to fail.



**Note:** If you cannot see how many blocks you have used in the strategy, open the Strategy Details dialog by clicking on Strategy Details in the Strategy tab of the Ribbon

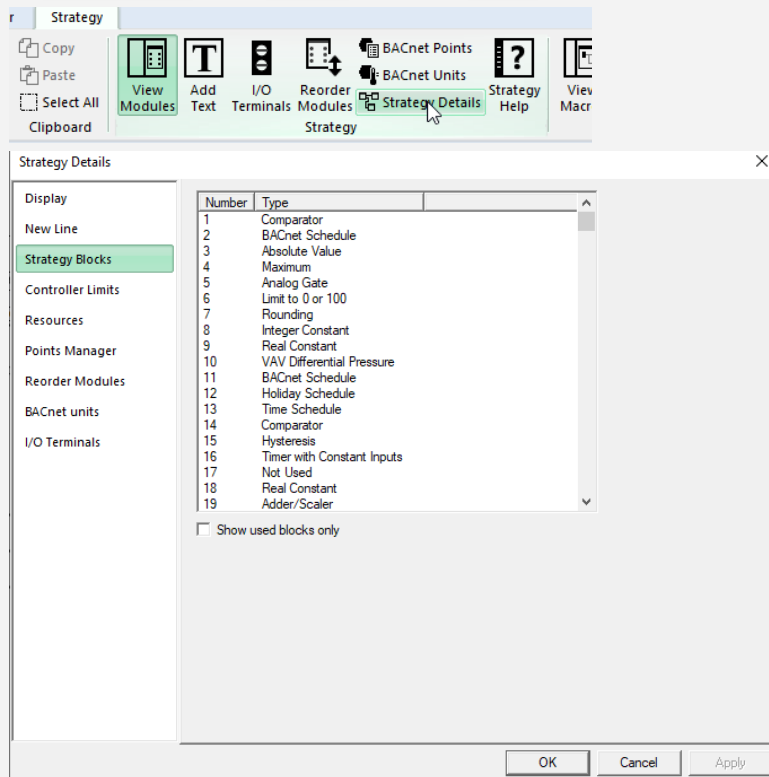

The Strategy Blocks tab lists all blocks in the targeted controller. The highest block number that is marked as used is the number of blocks the controller must service.

The Last Composed section of the Controller Configuration dialog automatically contains the current PC time and date. If the strategy is uploaded later, this time and date will indicate when the strategy was started.

The User ID parameter allows the application engineer to enter a unique identifying character. If the strategy is uploaded later, this number will indicate who started the strategy.

In the User Name field, the engineer can enter the name of the person that started the strategy and this can be retrieved from the controller if the strategy is uploaded. A string of up to sixteen characters can be entered in this field.

In the Drawing Name field, the name drawing can be entered. It is recommended that the name of the drawing containing information relevant to the strategy is stored here. If the setup is uploaded from the controller the drawing name will be displayed in this field.

## The effects of sending the setup

Sending the setup to a controller has the following effects:

- All blocks entered in the **Number of blocks to service** section will be serviced, even if they are not occupied by modules. For example, if you entered **100** as the number of modules to be serviced, the first **100** blocks will be serviced by the controller.
- A controller that is sent a setup with blocks to be serviced, but without any strategy, will not send any output signals and will not read any input signals.

**Note:** If a strategy is downloaded after setup is sent, the strategy is serviced immediately. This means the outputs will receive values from the strategy immediately after downloading. It would be preferable to download the strategy before sending setup since untested strategies can cause problems in devices connected to the outputs if the output values are unstable or incorrect.

- Output points of modules that occupy serviced blocks take their values from the module.
- If the controller is running without a network (stand-alone), the green LED is constantly illuminated.
- If the controller is running on a fieldbus (connected to a BACnet Router), the green LED flashes with regular pulses.
- An alarm appears on the monitor of the connected PC if the alarm feature is active.
- The keypad program, if one exists and has been downloaded to the controller, will be started.

## TESTING A STRATEGY WITH SCAN MODE

It is important to test a strategy at various stages in its creation, to check for mistakes or faults in its design. This is done by using **Scan mode**.

### PREPARING TO TEST A STRATEGY

To test a strategy the following conditions must be satisfied:

- The strategy must be open (see *How to open an existing strategy* on page 111).
- The strategy must have been sent to the controller (See *Downloading a strategy* on page 115).

**Note:** Make sure that the downloaded strategy and the open strategy are the same.

- The strategy must have been started (see *Starting a strategy* on page 120).

## HOW TO TEST A STRATEGY

In **Scan mode**, CXpro<sup>HD</sup> allows you to view the changes in values in a strategy as the strategy is serviced in the controller. This is useful for testing strategies and parts of strategies for correct operation. In **Scan mode**, the point values of an uploaded strategy are read by CXpro<sup>HD</sup>, displayed next to their respective inputs/outputs, and updated in real time.

To activate scan mode:

- Open the strategy and Connect to the controller by clicking the **Connect** button on the **Strategy** tab of the **Ribbon**
- Display the strategy's point and constant values (page 123)
- Set the **Scan mode** (page 123)
- Activate **scan mode** (page 124)

In scan mode, the variable point values of a strategy are updated in real time as they are serviced by the strategy and displayed clearly in the module symbols on the drawing area. In the **Rescale to 0 or 100** module of the example above, the values of the 3 input points were changed to **10**, **20**, and **149.86**, and its output was changed to **100** as they were serviced by the strategy.

- Watch the changing values of the modules in scan mode to ensure they are being serviced correctly by the controller.

### How to Display the strategy's point and constant values

Display the point and constant values of the strategy by right-clicking on the Drawing Area and select Display Options > Display Labels > Show Value Only (simulation)

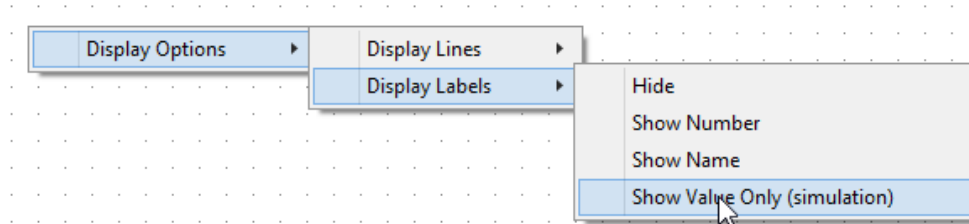

### Setting the Scan mode

CXpro<sup>HD</sup> can scan either the current active strategy or all of the currently open strategies. To set this, open the Applications Settings dialog by clicking Communications in the Controller tab of the Ribbon

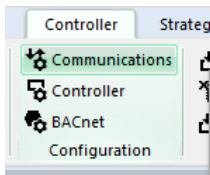

Select the Scan Options tab in the dialog, and select either the Scan Active Strategy or the Scan all Strategies radio button.

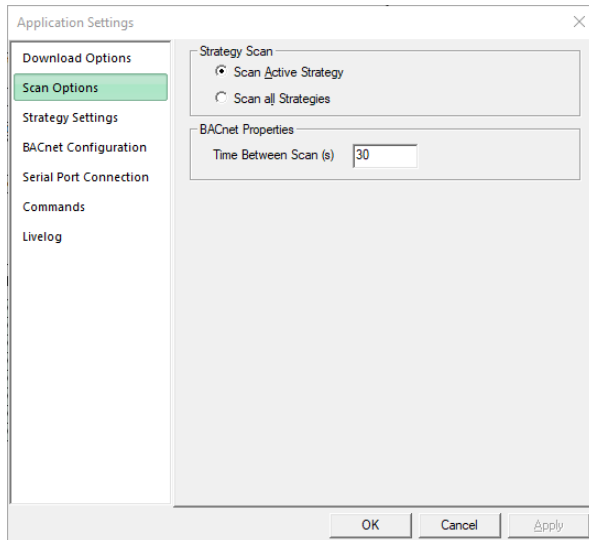

Click **OK** to close the dialog.

## Activate scan mode

Begin scanning by clicking **Scan** in the **Controller** tab in the **Ribbon**.

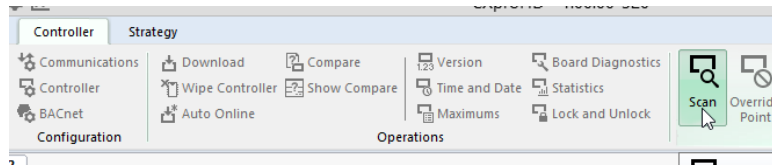

The CXpro<sup>HD</sup> window will change to the CXpro<sup>HD</sup> scan mode window, hiding the **Site List**, displaying the **Page Names** pane and disabling all of the **Ribbon** items except the **Scan** button

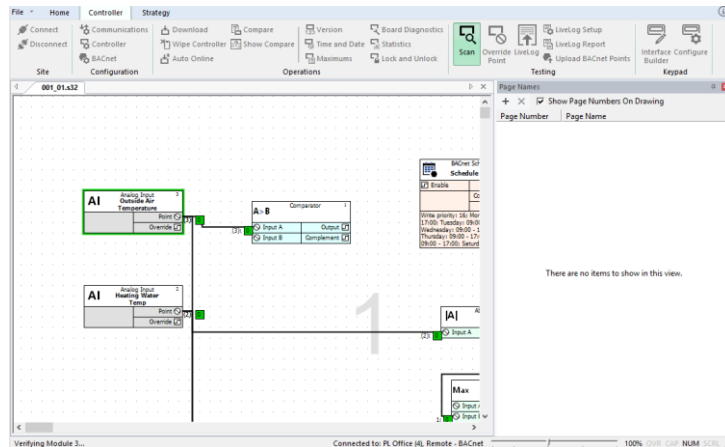

- To deactivate scan mode, i.e. to stop scanning the point values of the strategy, click the **Scan** button again.

## SUGGESTIONS FOR TESTING STRATEGIES

- If a number of modules are selected in the strategy when Scan mode is activated, then only those modules will be scanned.
- The module to be tested must have been downloaded to the controller. That is, the Block number of the module must be within the range of modules which were downloaded to the controller (see *Downloading a strategy* on page 115)
- A strategy should be tested in small steps during the creation process. Simple faults such as selecting the wrong module or joining to the wrong inputs and outputs can be difficult to correct in a finished strategy. There is also the danger that faults can result in other faults appearing in different parts of the strategy or in other controllers.
- At the end of the creation of a strategy, the whole strategy should be tested again. This prevents later problems and time losses during the setting-up process in the site.
- The strategy should be checked module by module from left to right, starting with the hardware inputs and finishing with the hardware outputs.
- Individual strategy parts can be functioning correctly themselves but cause problems when connected to other correctly functioning strategy parts. For example, the direction of analog values may fall in the range of 0 % to 100 % or the range of 100 % to 0 %. Digital values and their inversion may also cause confusion.
- Test a strategy before copying it or using it in another controller. Otherwise, all copies of the strategy will also have to be tested.
- Manually overriding hardware points allows simulation of each environmental situation to which the strategy would be exposed.

## SECURING CBM DATA

Unlike other BMS controllers, in the **CBM** strategy information can be secured against accidental loss or unauthorized modification by password-protecting the ability to view or edit strategy information and system information.

### HOW TO PASSWORD-PROTECT A RANGE OF BLOCKS IN A CBM STRATEGY

To lock a range of blocks in a strategy, select **Lock and Unlock** from the **Controller** tab of the **Ribbon**.

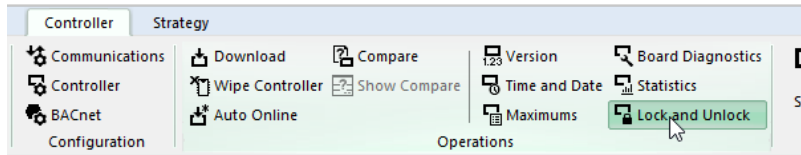

This opens the **Lock and Unlock** dialog

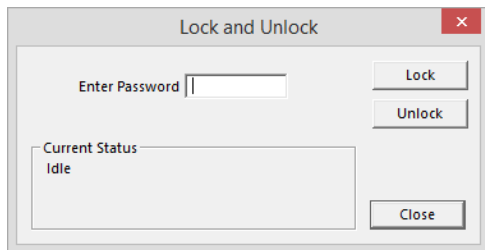

Enter a numerical password (note: the **Enter Password** field will only accept numbers) and click **Lock**

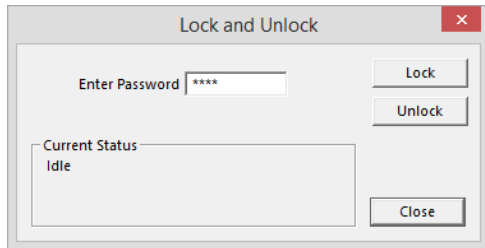

The **Lock Blocks** dialog opens. Specify the start and end of the range of blocks that will be protected:

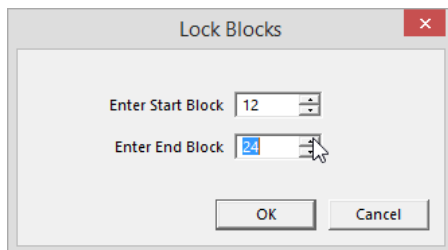

Click **OK** to close the **Lock Blocks** dialog

When the lock command has been received by the controller a confirmation message is displayed in the **Lock and Unlock** dialog.

All of the strategy blocks within the specified range are now locked, and cannot be accessed until they are unlocked using the password set above.

## HOW TO ACCESS LOCKED STRATEGY BLOCKS

If a range of strategy blocks in a CBM controller have been locked, it is only possible to access, view, and edit them by first unlocking them, using the password set during the locking process.

To remove password protection from a locked range of strategy blocks, select **Lock and Unlock** from the **Controller** tab of the Ribbon.

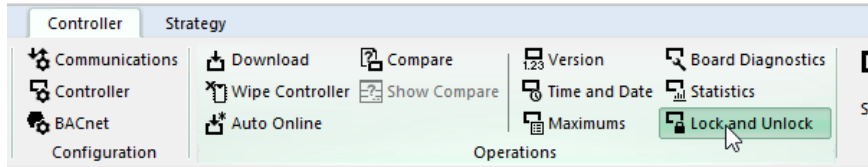

This opens the **Lock and Unlock** dialog. Enter the required numerical password (set during the locking process) and click on **Unlock**.

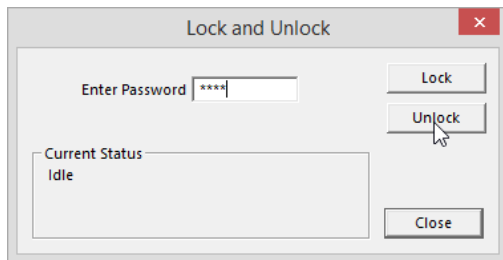

When the blocks are successfully unlocked in the controller, a message is displayed in the **Lock/Unlock** dialog. The strategy blocks are now unprotected and can be accessed from CXpro<sup>HD</sup> as normal.

## HOW TO EXPOSE POINTS ON A BACNET SYSTEM

When the strategy has been configured for a controller that is part of a BACnet Site, the points within the controller that are to be available to the BACnet system must be specified by selecting **BACnet Points** from the **Strategy** tab of the **Ribbon**

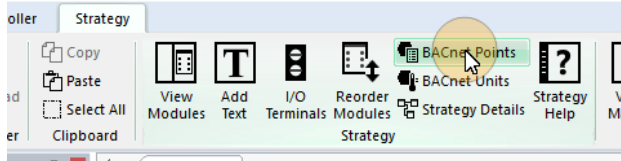

The **BACnet Points** dialog opens, listing all of the points used in the strategy:

BACnet	Export	Point Name	Point Addr	Point Type
<input checked="" type="checkbox"/>	<input type="checkbox"/>	Room Setting	5	Analog Setpoint
<input checked="" type="checkbox"/>	<input type="checkbox"/>	MaxHWater	28	Analog Virtual
<input checked="" type="checkbox"/>	<input type="checkbox"/>	Adder/Scaler Block 19 Output	29	Analog Virtual
<input checked="" type="checkbox"/>	<input type="checkbox"/>	WeatherCom Block 8001 Inpu	30	Analog Virtual
<input checked="" type="checkbox"/>	<input type="checkbox"/>	Heating Water Temp	2	Analog Input
<input checked="" type="checkbox"/>	<input type="checkbox"/>	Temperature	3	Analog Input
<input checked="" type="checkbox"/>	<input type="checkbox"/>	Alarm Enable	2	Digital Setpoint
<input checked="" type="checkbox"/>	<input type="checkbox"/>	DigVirt_3	3	Digital Virtual
<input checked="" type="checkbox"/>	<input type="checkbox"/>	Schedule No. 1 (On)	4	Digital Virtual
<input checked="" type="checkbox"/>	<input type="checkbox"/>	Hysteresis Block 15 Active High	9	Digital Output

BACnet Point Usage		Binary Unit String Usage	
Maximum BACnet	224	Maximum Binary Unit	32
Used BACnet	10	Used Binary Unit	3
Available BACnet	214	Available Binary Unit	29
Export Total	0		

Setpoint Limits	
Max Unexposed Setpoint and BACnet	324
Unexposed	0
Available Setpoints / BACnet Points	314

Resolve Duplicate Point Names

OK Cancel

Tick the checkbox beside each of the points that are to be exposed, then click on **OK**.

**Note:** In BACnet, the point name must be unique. In the **ABB Cylon**<sup>®</sup> BACnet system, they may not be unique, so some duplicate names may appear in the list. If this is the case, click the **Resolve Duplicate Point Names...** button. This opens the **Resolve Duplicate Point Names** dialog, where names can be changed.

**Note:** The **BACnet Points** dialog also includes columns of the checkbox to identify points that should be included in any export to **ASPECT**<sup>®</sup> / **INTEGRA**<sup>™</sup> – see **ASPECT**<sup>®</sup> / **INTEGRA**<sup>™</sup> *Export* on page 200.





## 7 Naming Objects

### WHY OBJECTS ARE NAMED

Objects in the CXpro<sup>HD</sup> system, such as controllers, points, time schedules, datalogs, etc. are given names to make them more identifiable. For example, it is easier to recognize a datalog named “Water Supply Temperature” than one named “data`log_1`”, which is the default name of the first datalog used inside a controller, automatically given by the database.

### RULES FOR NAMING OBJECTS

When naming an object in the system, the following rules should be remembered:

- Names inside a controller must be unique.
- Names can have a maximum of 24 characters.
- All alphanumeric characters are permitted, except commas.
- If the name of an object in a controller is changed to a name that already exists in that controller, the name of the original object will be deleted.

### PROCEDURES FOR NAMING OBJECTS

The following list contains some of the objects in the system that can be named:

- Sites
- Field Controllers and BACnet Routers
- Points (both hardware points and virtual points)
- Datalog and Time Schedule modules

### NAMING POINTS

#### Types of point

There are three main types of point in the CXpro<sup>HD</sup> system:

- A hardware point is an input or output of a Field Controller.
- A virtual point is used to save internal information for a controller.
- A setpoint is a type of virtual point, but its value is constant, whereas the value of a virtual point is determined by the strategy.

Hardware points, virtual points, and setpoints can be either analog or digital.

#### How to name points

Only hardware and setpoints can be named in CXpro<sup>HD</sup>. Virtual points are identified by their block numbers. The procedure for naming or changing the name of a set point is the same as that for a hardware point. A brief summary of the procedure is presented below. (For a more detailed description of how to name a point, see *Defining hardware points* on page 74)

- Open the strategy.
- Select the Point module on the drawing area that is to be named or have its name changed.
- Enter or edit the text in the **Name** field of the **Properties** pane.
- Choose **Save** from the **File** menu to save the changes made to the strategy.

The **Database Interface** module can be used to enter/edit/delete names of hardware points non-graphically.

Virtual points which are placed in a strategy as digital setpoints or analog setpoints are points which are controlled from outside the **Field Controller**. The name of such a virtual point should indicate how its value is passed to it. The following table illustrates this:

Setpoint name	How to set point value is controlled
Outair Temperature_LG	Controlled by 3rd party block
Room Temperature_WG	Controlled by 3rd party block
Set point_KP	Can be changed via the keypad
Gain Factor_PC	Can be changed via PC (B-OVS)

## NAMING FIELD CONTROLLER TIME SCHEDULES

Controller Time Schedules are saved and serviced just like modules in a controller. Naming Controller Time Schedules make it easy to locate them for editing, either using the PC, supervisor software, or a keypad.

### How to name a Field Controller time schedule

The procedure for naming or changing the name of a Controller time schedule is defined below:

- Open the strategy.
- Select the Point module on the drawing area that is to be named or have its name changed.
- Enter or edit the text in the **Name** field of the **Properties** pane.
- Choose **Save** from the **File** menu to save the changes made to the strategy.

When naming the schedule, it is a good idea to indicate the module’s function. For example, if the module is a time schedule for the heating system of the site, and is set for Monday to Friday only, the module might be named “**Heating Schedule (Mon to Fri)**”.

## NAMING DATALOGS

Datalogs are saved and serviced just like modules in a controller. The contents of a Datalog can be viewed and analyzed using the **Datalog Manager** module. So that they can easily be identified by the **Datalog Manager**, they are automatically given the same name as the point that they are logging. They are given this name when the point is connected to the datalog. In the **Reports** program, datalogs can be configured and archived.

### How to name a datalog

Datalogs are automatically named as soon as they are connected to a point:

Open the strategy that contains the datalog.

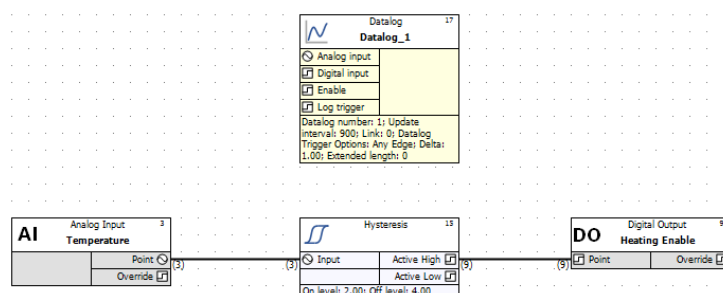

Join the datalog to a point by clicking on the point to be logged, and dragging to the Datalog’s input:

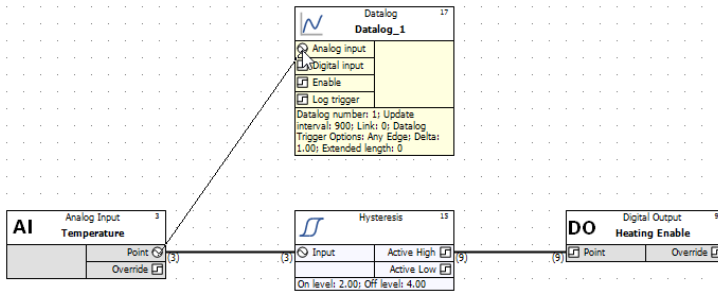

The name of the Datalog is changed to the name of the point and displayed in the Datalog module in the strategy.

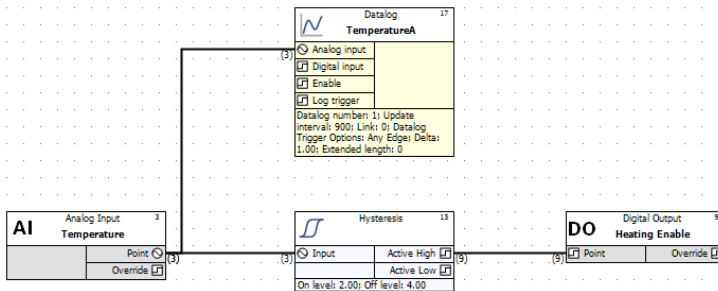

If you want to modify the name that is automatically given, you can edit it by selecting the datalog module and editing the **Name** field in the **Properties** pane.

It is a good idea to give an indication in the name of what part of the site the datalog belongs to, but it is not necessary to indicate in the name that the module is a datalog, as it will only appear in list boxes allowing the selection of a datalog. Names that are given to only speed up the copying of strategies (for example, “Temp. Channel 1”, “Temp. Channel 2”, “Temp. Channel 3”, ...), and to save time for creating dynamic graphics, are not helpful for the end-user.

Choose **Save** from the **File** menu to save the changes made to the strategy.

## 8 Using Macros

### MACROS - OVERVIEW

If your work in CXpro<sup>HD</sup> involves creating the same or similar strategies repeatedly, you'll find Macros useful for reducing the time involved in these tasks. A Macro is a set of strategy modules grouped together into a single unit.

### MACROS AND MACRO TEMPLATES

A Macro Template is used to create a macro within a strategy. It is a definition of module types and connections, and when it is inserted into a strategy a new Macro is created containing new instances of those module types connected together to match the Macro Template.

- Each time a Macro Template is inserted into a strategy, a new Macro is created.
- Each Macro is an instance of a Macro Template, but a strategy can contain multiple Macros that are based on a single Macro Template.
- Macro Templates can be stored, and copied between strategies and controllers.
- Each Macro can be configured and adjusted independently of the Macro Template used to create it.
- When a Macro Template is saved, it acts as a CXpro<sup>HD</sup> module.

**Example:** An "Adder" macro.

An **Adder/Scaler** module accepts four inputs A, B, C and D, and operates according to the equation

$$\text{Output} = A * C + B * D$$

It can be made into an **Adder**, which operates according to the equation

$$\text{Output} = C + D$$

by ensuring that its A and B inputs are always set to 1. This can be done by connecting a **Real Constant** module to the A and B inputs as shown below.

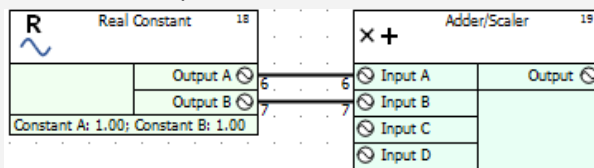

This combination of modules can be saved as a Macro Template and reused whenever an adder is required.

### MACRO STRUCTURE

Macro Templates are stored in CXpro<sup>HD</sup> in groups and sub-groups. A maximum of 10 Macro groups can be created. Each Macro group can contain 20 sub-groups and each sub-group can contain up to 100 Macro Templates. In total, 20 000 Macro Templates can be created and stored in CXpro<sup>HD</sup>.

For example, you may want to store all Macro Templates relating to heat control strategies in a group called Heat. This group may contain a sub-group called Boiler, which would contain Macros for boiler control strategies, such as Optimizer, Heating Curve, etc.

### MACRO DESCRIPTION (HELP) FILES

A Macro **Description File** is a Help file generated by the person who created the Macro Template and is associated with the Macro Template (it is opened by right-clicking on the Macro button). It is normally used to describe the function and usage of the Macro Template.

When a user right-clicks on a Macro in the **Macro** property window, CXpro<sup>HD</sup> opens the editable description file associated with that specific Macro Template. If none exists, CXpro<sup>HD</sup> opens a blank text file, which when

saved will be associated with that Macro Template. This file can be used to provide documentation about how the Macro should be used or to record history, author, or changelog details for the Macro Template.

The program used by CXpro<sup>HD</sup> to open the history file, e.g., MS Wordpad, must be specified in the C:\CXproHD\System\wn3000.ini file under UC16et.

## HOW TO CREATE A MACRO TEMPLATE

There are a number of steps involved in creating a Macro Template:

1. Create the strategy.
2. Add modules to the Macro Template.
3. Select the inputs and outputs for the Macro Template and change their names if required.
4. Set names for each of the points within the Macro Template if required.
5. Choose a Macro group and sub-group and give the Macro Template a name.
6. Choose whether to insert the Macro Template into the active strategy as a Macro.
7. Save the Macro Template.

The following guide to creating a Macro uses as an example a typical strategy that you might want to save as a Macro – a “**weather compensator**” strategy. As an exercise in creating Macros, you may want to follow this guide, using the **weather compensator** as an example.

### CREATE THE STRATEGY

Create the strategy or part of a strategy on which you are basing your Macro Template. (If you are forming your Macro Template from an existing strategy, then **open** that existing strategy).

#### Example – Weather Compensator macro

For example, if you were to create a Macro Template from a weather compensator strategy, you would place two Real Constant modules and two Rescale to 0 and 100 modules on the drawing area and join them as shown below:

The third input of the first Rescale module (Rescale to 0 and 100) is to be the input of the Macro. It is marked Outside Air Temperature in the diagram below.

The output of the 2<sup>nd</sup> Rescale module (Rescale from 0 to 100) is to be the output of the Macro. It is marked Flow Temperature Setpoint in the diagram below.

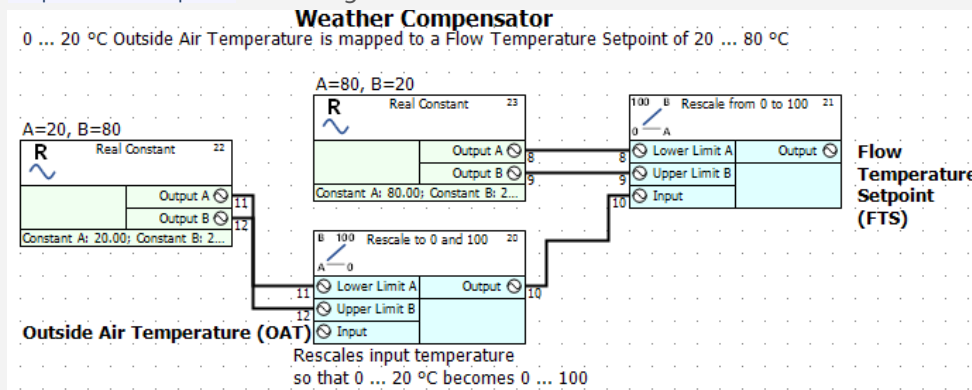

## SELECT THE MODULES FOR THE MACRO

The next stage in creating a Macro is to select on the drawing area the modules and any text that you want to be included in the Macro. Selected modules are marked by red squares around their edges.

To select the modules for the Macro, you can drag the mouse from the top left-hand corner to the bottom right-hand corner of the strategy to draw a box around the entire strategy so that each module and its inputs and outputs are selected. It is not a problem if, when drawing the box, you included some unwanted modules – they can be easily removed at the next stage.

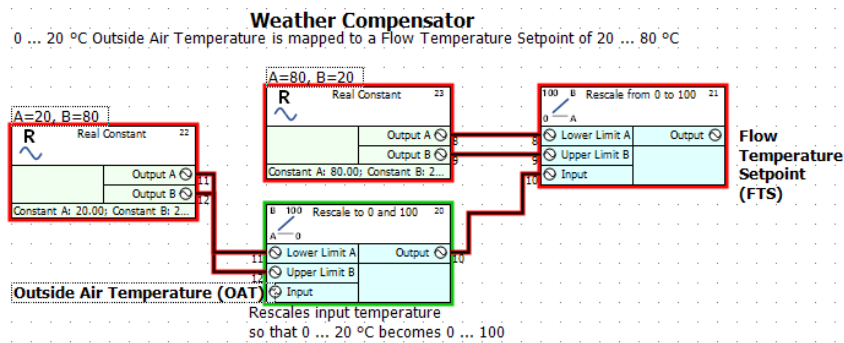
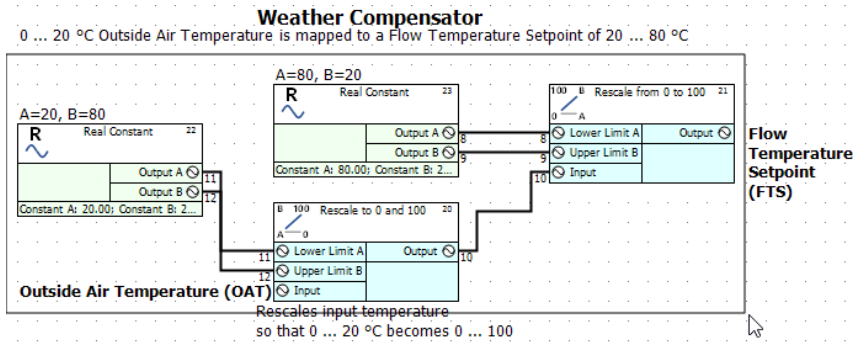

## ADD THE SELECTED MODULES TO THE MACRO TEMPLATE

Select **Create** from the **Macro** section of the **Strategy** tab on the **Ribbon**.

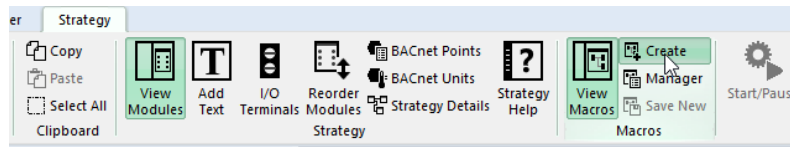

This will open the **Add Modules to Macro** dialog box, in which all of the modules that you selected for the Macro Template will be listed.

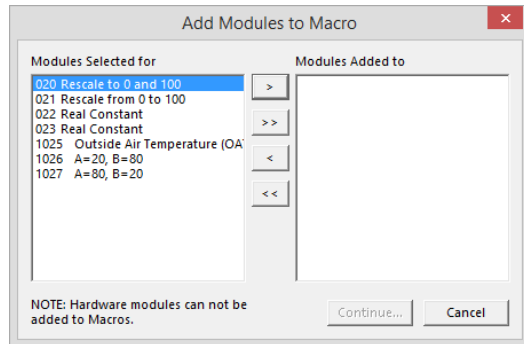

**Note:** A Macro cannot include hardware points, so if any were included in the selection they will not be listed in the Add Modules to Macro dialog.

**Note:** If you click the **macro** button or **macro** menu without first selecting the modules for the macro, you will be prompted to do so with the following error message:

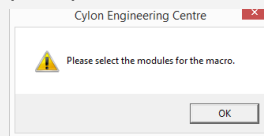



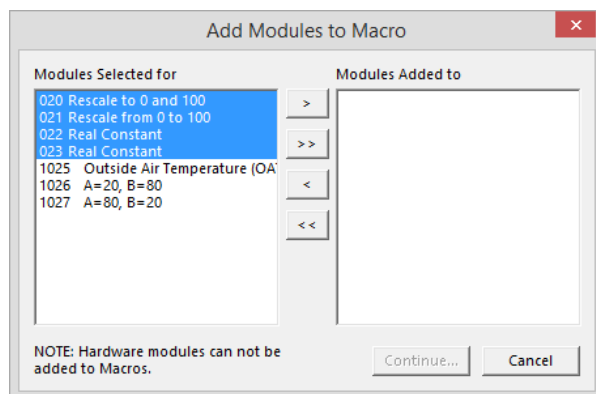

Select the modules in the left list box that you want to include in the Macro by holding down the **[Ctrl]** key and clicking each one with the left mouse button. The selected modules will be highlighted.



**Note:** For illustration, only the functional modules have been selected in this example. It is also possible to include text in a Macro Template for clarity.

Add the selected modules to the Macro Template using the following buttons:

-  Add a selected module or several selected modules to the Macro Template
-  Add all modules to the Macro Template
-  Remove a selected module or several selected modules from the Macro Template
-  Remove all modules to the Macro Template

This **Add Modules to Macro** list box displays all the modules that have been added to the Macro Template. If you add a module or modules that you later decide you do not want, you can remove that module or modules from the Macro Template using the remove buttons (see above).

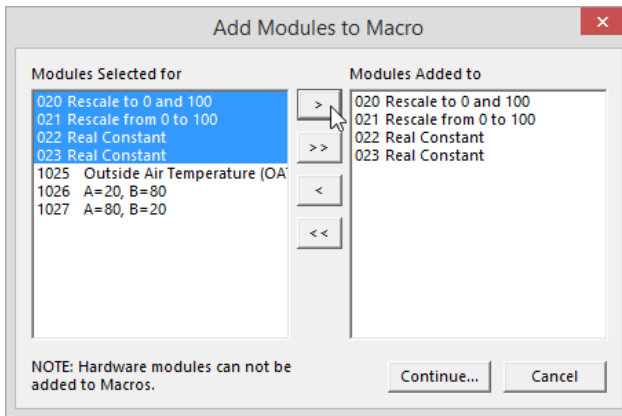

In this example, all 4 modules of the weather compensator strategy are required for the Macro Template and so they are added to the list box on the right. The text has been excluded in this case but could be included for extra information.

Click **Continue...** when you have added the required modules to the Macro Template.



## DEFINE THE MACRO INPUTS, OUTPUTS, GROUP AND NAME (THE CREATE MACRO DIALOG BOX)

Pressing the **Continue...** button in the **Add Modules to Macro** dialog will open the **Create Macro** dialog box:

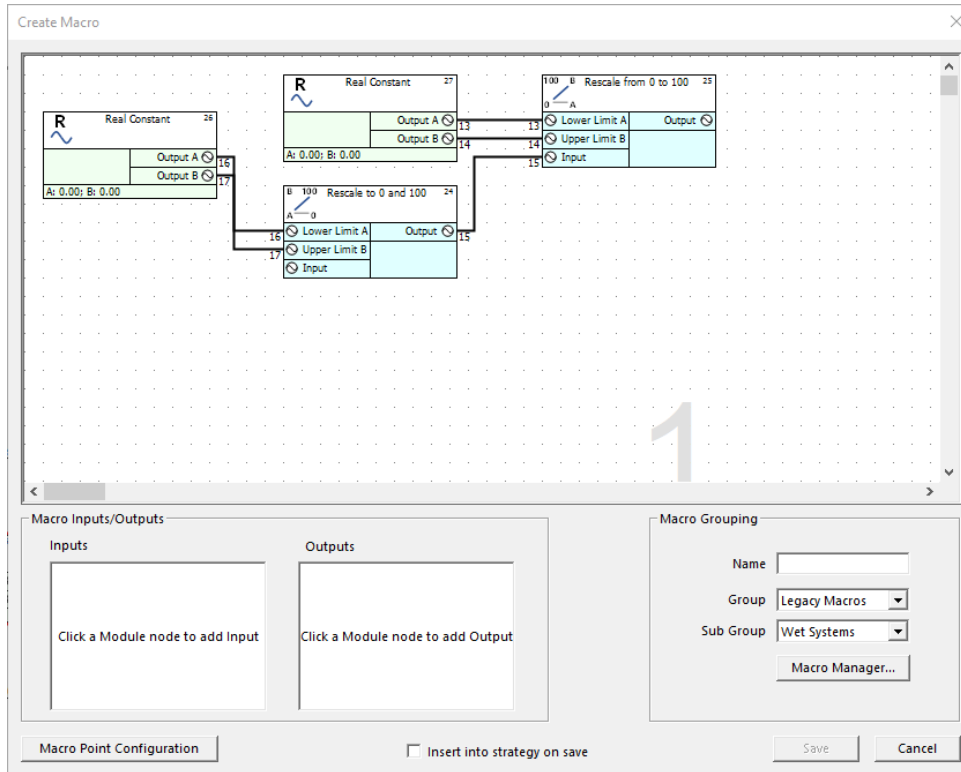

The **Create Macro** dialog shows the four modules that were added in the **Add Modules to Macro** box and allows you to edit input and output names, create Macro groups and sub-groups and create a history file to record any changes that may be made to the Macro Template later.

## Define the inputs and outputs for the macro

This step refers to the Weather Compensator example (see page 133).

When you click on a module output or an unconnected module input in the drawing area of the **Create Macro** dialog, it is highlighted on the drawing area and added to the relevant **Macro Inputs** or **Macro Outputs** list at the bottom of the dialog.

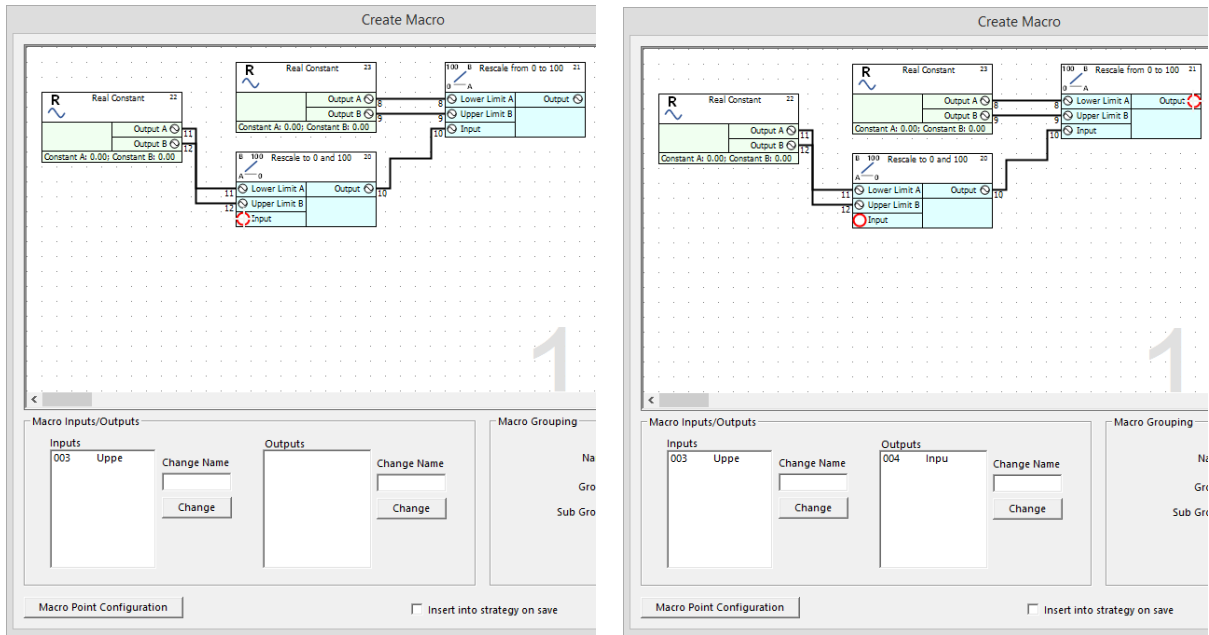

**Note:** If you click on a connected input, an error message will be displayed: “Cannot select a module input that is already connected to a line.”

**Note:** The number beside each module input is the Node number and does not relate to the module number.

**Note:** The default name for node 3 in the illustration is “Inpu”, but this can be edited - see *Change input or output label if necessary* on page 139.

To remove an input or output that has been added to the Macro Template, click on it in the drawing area. The input/output will then no longer be highlighted in the drawing area, and it will be removed from the relevant **Macro Inputs** or **Macro Outputs** list.

You can rearrange the order of the inputs or outputs to the Macro, by clicking on an entry in the relevant **Macro Inputs** or **Macro Outputs** list and dragging it up or down within the list.

### Change input or output label if necessary

By default, the text that will be displayed on the Macro module as a label for each input will be “Inpu” and for each output will be “Outp”:

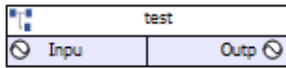

but these names can easily be edited.

To edit a Macro input or output name, select the input/output name in the relevant list box

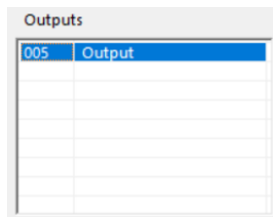

Type a new name in the relevant **Name** edit box and press **[Enter]**.

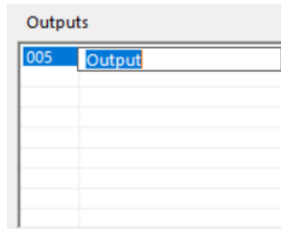

An input or output label can have no more than 10 alphanumeric characters.

## Name and group the Macro

In order to use a Macro Template that you have created, you must give the Macro Template a name, and assign it to a **Macro group** so that it can be accessed from the **Macro bar**.

### Macro Name

In the **Macro Name** box, enter a name for the Macro Template.

The name provided here will appear on the Macro instance when it is displayed on the drawing area. It can have up to 63 alphanumeric characters.

In this example, the name given to the Macro Template is “WeatherCom”.

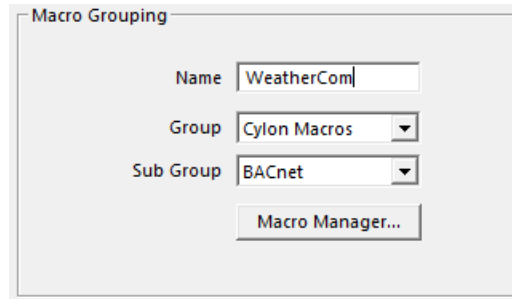

**Note:** The following names cannot be used when naming a macro, because they are used to indicate Inputs, Outputs, constants, etc. internally within CXpro<sup>HD</sup>:

- pi (n) where n = a numeric value in the range 0-9
- po (n) where n = a numeric value in the range 0-9
- sb
- c (n) where n = a numeric value in the range 0-9
- bc

When the Macro Template is named, choose a Macro group and sub-group for it

### Macro Group and Sub-Group

From the **Group** box, select the group to which the **Macro** you are creating will belong.

The Macro Group chosen for this example is heating.

If no Macro Group exists, you must create a new group (see *How to create a new macro group and sub-group* on page 143 ) by clicking the **Macro Manager...** button.

From the **Sub Groups** box, select the sub-group to which the Macro Template you are creating will belong.

The sub-group chosen for this example is **Boiler**.

If no sub-group exists, you must create one (see *How to create a new macro group and sub-group* on page 143 ) by clicking the **Macro Manager...** button.

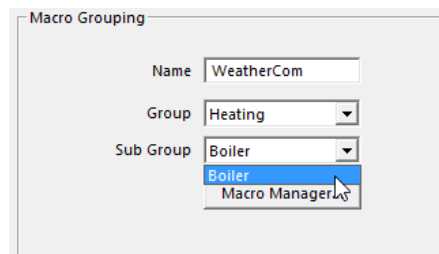
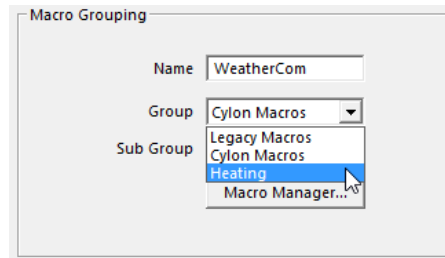

## Set names for all points in the Macro

When creating a Macro Template, there is a facility to edit the names of all the points in the Macro in a single interface. A **Macro Point Configuration** button is available on the **Create Macro** dialog:

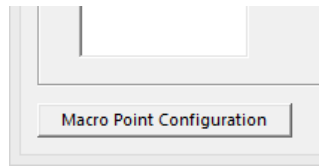

Clicking the **Macro Point Configuration** button opens the **Macro Point Configuration** dialog:

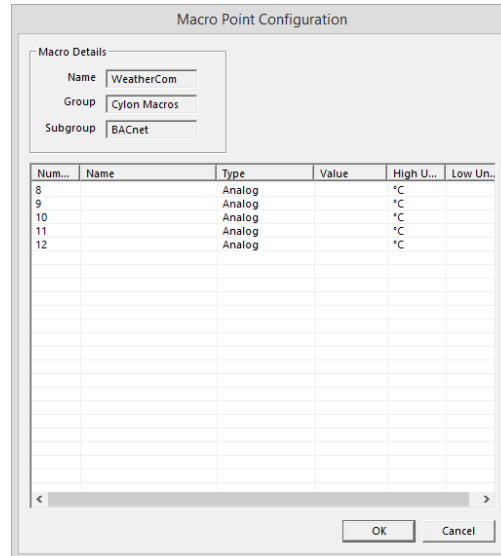

Simply enter text in the **Name** column against each point and click the **OK** button.

**Note:** If the modules selected when creating the Macro included any Setpoints, it is possible to set labels for specific setpoint values

**Note:** This is different from setting the Input and Output names (labels) as described in *Change input or output label if necessary* on page 139. Those input and output names are labels displayed on the Macro module; the point names set here are the descriptive names stored for each of the points in the strategy.

### CHOOSE WHETHER TO INSERT THE MACRO INTO THE ACTIVE STRATEGY

The **Insert into Strategy** checkbox allows you to immediately insert a new Macro based on this Macro Template into the active strategy.

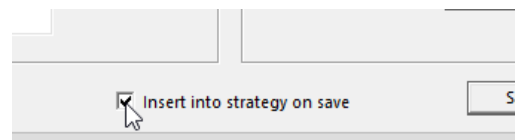

If you want to insert the Macro into the active strategy, select this option before saving the Macro Template.

### SAVE THE MACRO TEMPLATE

To save the Macro Template, click the **Save** button.

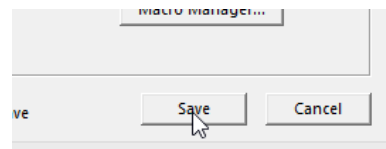

The Macro Template is saved to the `C:\CXproHD\Macros\` directory if it was created in a UCU or UC16 strategy, or in the `C:\CXproHD\UC32Macros\` directory if it was created in a CBM or CBT strategy. The group and subgroup information is stored in the `macro_database.db` file in the same directory.

If you decide not to save the Macro Template, click the **Cancel** button to close the **Create Macro** dialog box without saving.

When you save the Macro Template, an entry is added to the Macro pane:

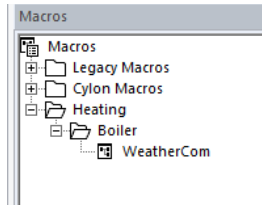

The Macro symbol is the bitmap that represents the Macro on the drawing area. (See *Working with Macros* on page 150).

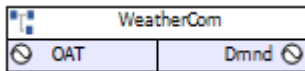

## HOW TO CREATE A NEW MACRO GROUP AND SUB-GROUP

Macro Groups and Sub-Groups are defined in the **Macro Manager** interface.

Open the **Macro Manager** by selecting **Manager** from the **Macro** group on the **Strategy** tab of the **Ribbon**

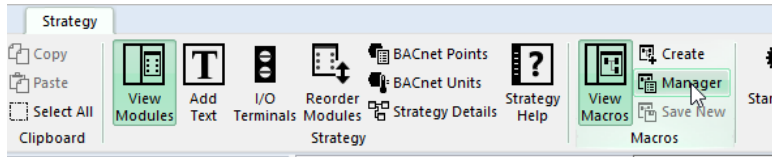

or by clicking the **Macro Manager...** button on the **Create Macro** dialog

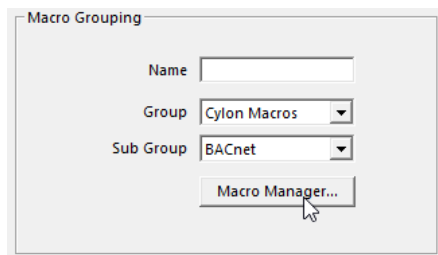

This opens the **Macro Manager** window

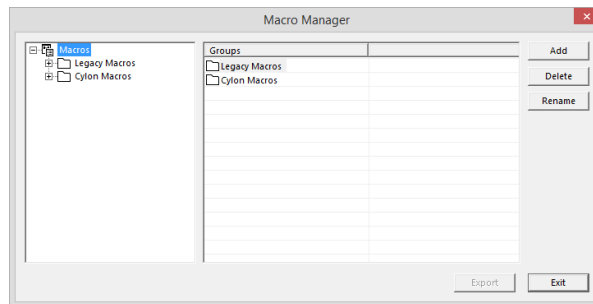

To add a group, click the **Add** button while the **Macros** root is selected in the **explorer pane** (left hand side of the window)

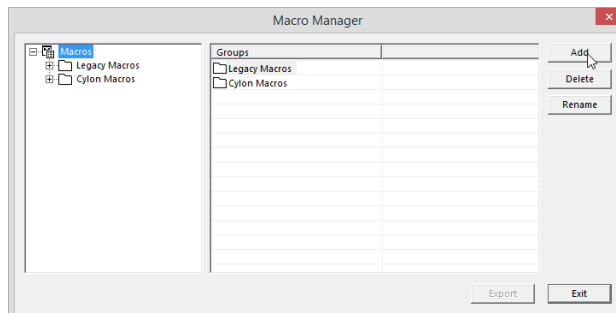

A new group appears in the Right-hand side **Group** pane.

Type in a name for the new group.

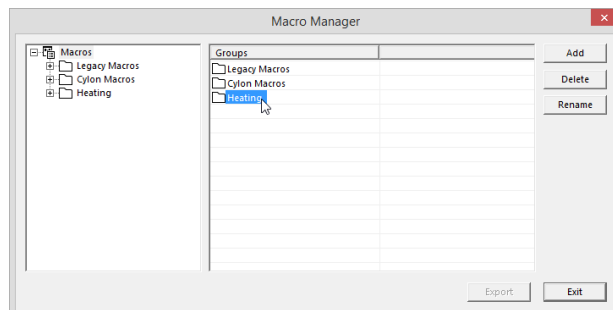

To make a sub-group in the new group, first, make groups visible by clicking on the **+** sign to the left of the **Macros** root.

Click on the group under which you want to make a sub group.

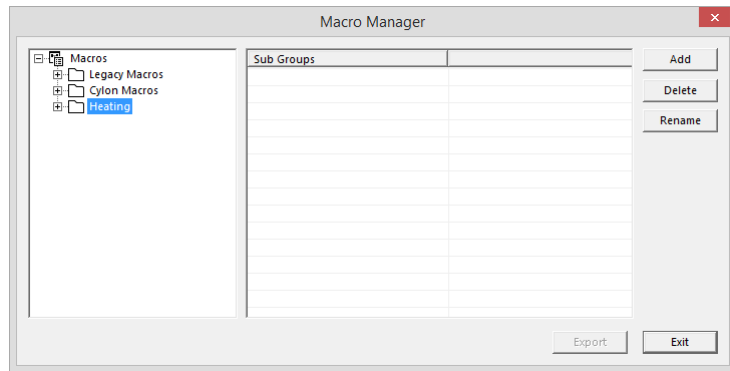

Click on the **Add** button.

A new sub group appears in the right-hand "Sub groups" pane.

Type in a name for the sub group.

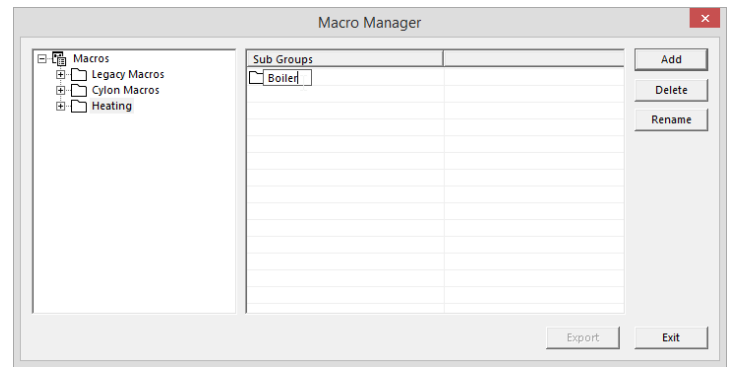

You can view the subgroups under a group by clicking on the "+" sign to the left of the group in the left-hand explorer pane.

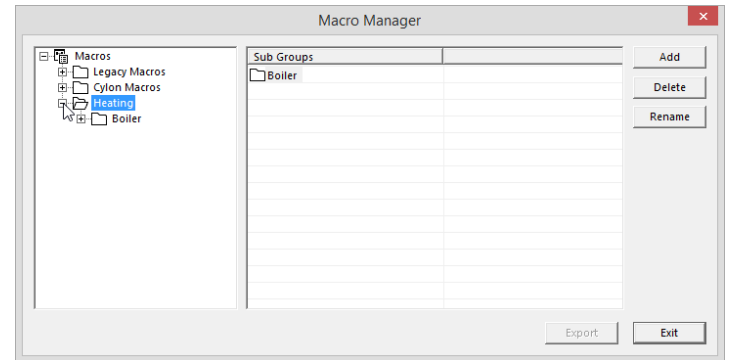

To close the **Macro Manager**, click **Exit**.

When a new Macro group is created, it will be listed under **Macros** in the **View** menu. When a new sub-group is created, an icon is also created for that sub-group and displayed in the Macro sub-group bar.



## HOW TO RENAME POINTS IN A MACRO TEMPLATE

Points can be renamed from the **Macro Manager** interface.

Open the **Macro Manager** by selecting **Manager** from the **Macro** group on the **Strategy** tab of the **Ribbon**

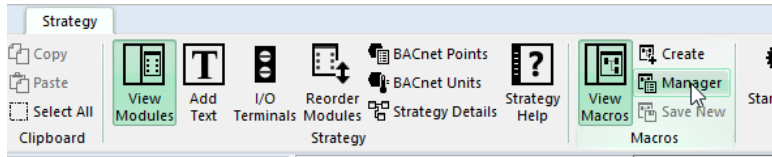

or by clicking the **Macro Manager...** button on the **Create Macro** dialog

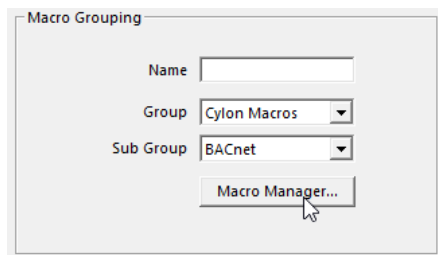

Clicking on a Macro Template in the left-hand-side 'Tree view' pane of the **Macro Manager** displays properties of the Macro Template in the right-hand pane.

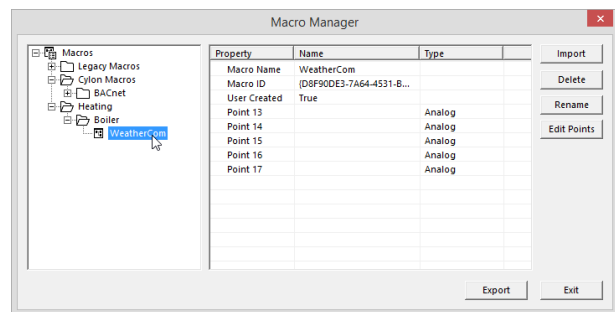

The **Macro Name**, **Macro ID**, **User Created** flag, and the list of point names are displayed.

If point names have already been defined, then an **Edit Point Names** button will be displayed on the right-hand side of the dialog.

If there is no point names list, then a **Create Point Names** button will be displayed instead.

Clicking either button will open the **Macro Point Name Prefix** dialog, allowing point names to be edited for the current instance.

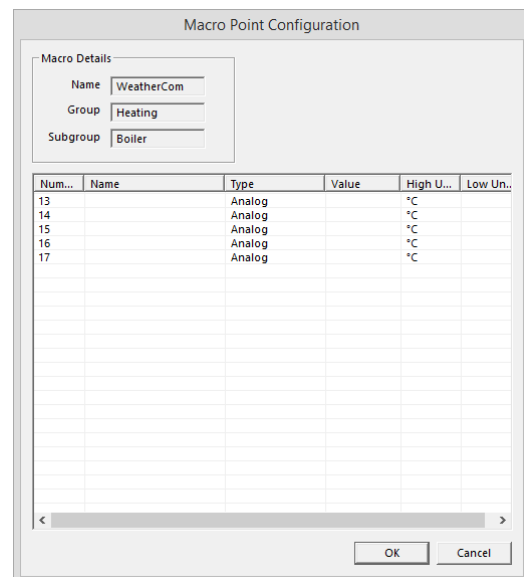

However, if this dialog is opened from the **Macro Manager** as shown here instead of from the **Create Macro** dialog, then when **OK** is clicked the Macro Template is changed and any Macro instances created afterward will use the updated point names list.

## HOW TO SET MACRO SETPOINT UNIT LABELS

In the **Macro Point Configuration** dialog, it is possible to set labels for specific setpoint values, so that a user can for example select “Night” and “Day” for a digital setpoint, or “off”, “on”, “trip” and “switch” for an analog point, without the need to know which numerical value matches each function.

To set an enumerated list for a setpoint, right-click on the setpoint in the **Macro Point Configuration** dialog and select **Add/Edit Enumerates**.

**Note:** This option is only available for setpoints.

**Note:** This option will not be available when a Macro is being added to a strategy, or when a Macro instance is being edited within a strategy – in those cases when the **Macro Point Configuration** dialog opens the user will be allowed only to select from an existing enumerated list, or to type a value.

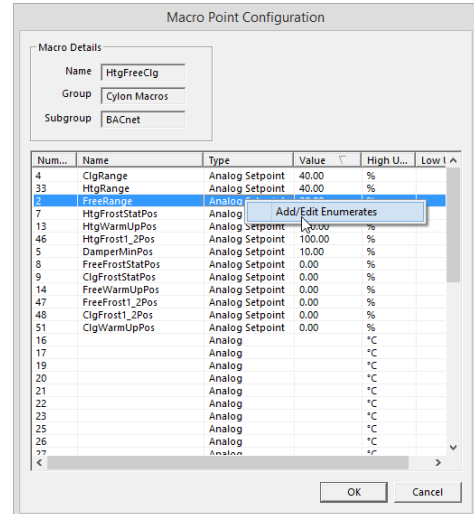

This will open the **Setpoint Enumerates** dialog.

Enter a **Value** and **Description** pair, and click the **Add** button. The Value/Description pair will be added to the list.

If an entry is made in error it can be removed from the list by selecting it and clicking the **Delete** button.

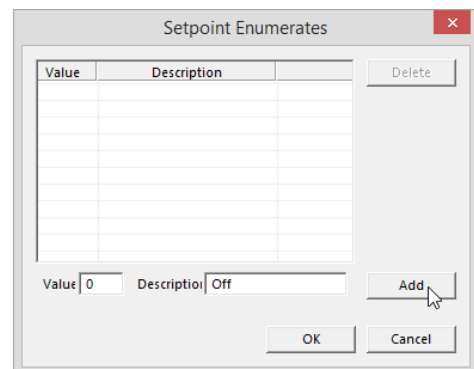

When the list is complete, click **OK** to close the **Setpoint Enumerates** dialog.

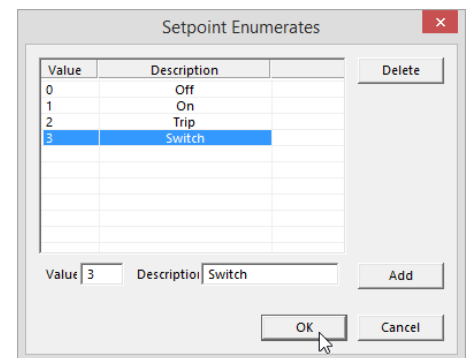

Now, when editing the setpoint, the user can select the required value from a drop-down list.

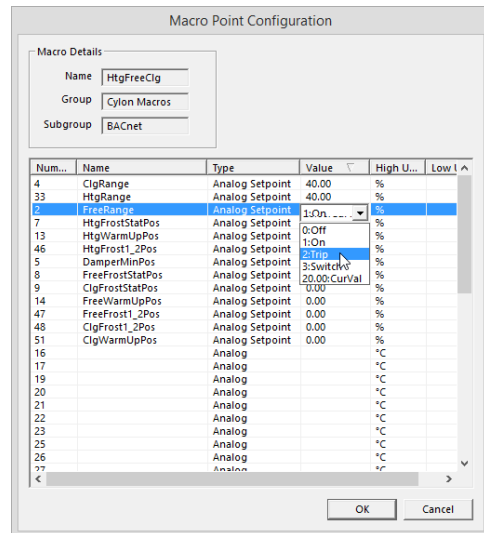

The setpoint value is displayed in the list with the text description.

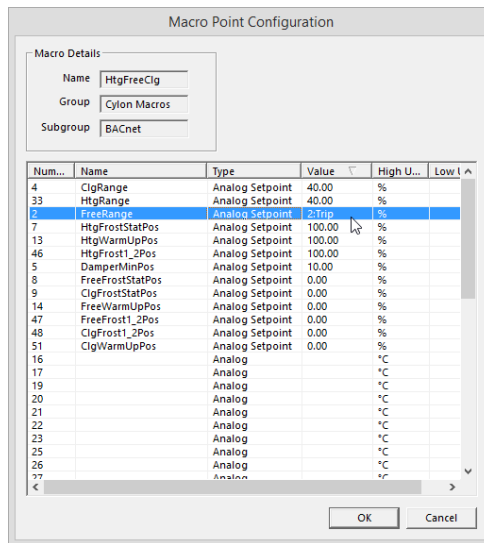

The enumerated list is saved with the Macro template and will be available in all instances of the Macro created afterward.

## HOW TO TRANSFER MACROS FROM ONE COMPUTER TO ANOTHER

It is possible to use Macro Templates created on one PC on a different PC. They must be exported from the PC on which they are created, and added to the 'host' PC system (i.e. the PC on which they will be used) as follows:

### EXPORT MACROS FROM THE PC ON WHICH THEY WERE CREATED

Exporting Macro Templates as follows puts each Macro Template in a separate file with a user-identifiable name so that they can be easily identified and moved to the 'host' PC system.

Open the Macro Manager by selecting **Manager** from the **Macro** group on the **Strategy** tab of the **Ribbon**

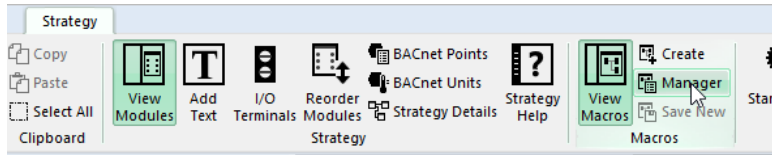

or by clicking the **Macro Manager...** button on the **Create Macro** dialog

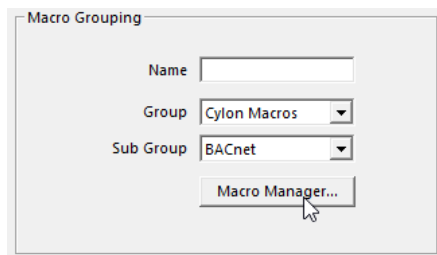

Select the Macro group that contains the Macro Templates you wish to export,

select all of the Macro Templates within that group that you wish to export,

and click the **Export** button.

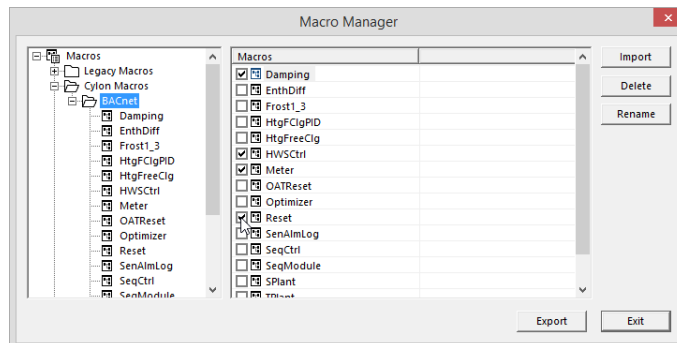

A **Select Folder** dialog will open. Select the location into which the selected Macros will be saved.

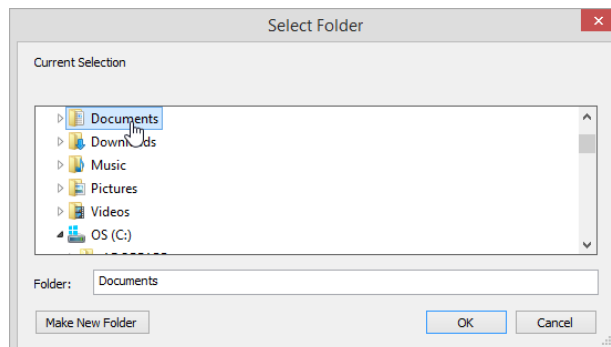

## ADD EXPORTED MACROS TO THE HOST PC SYSTEM

Once all required Macros have been exported, copy them onto the PC on which they will be used.

Open the Macro Manager by selecting Manager from the Macro group on the Strategy tab of the Ribbon

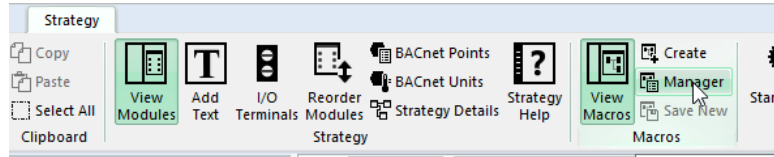

or by clicking the Macro Manager... button on the Create Macro dialog

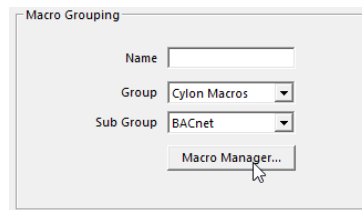

Select the group and subgroup **into** which you wish to import Macro Templates,

and click on the **Import** button.

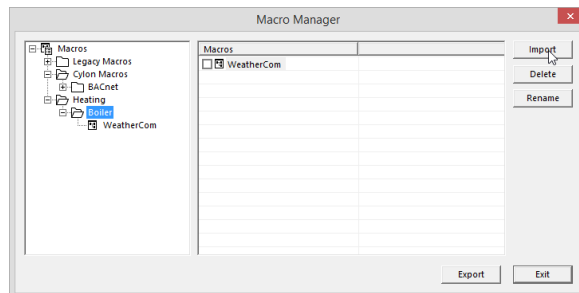

In the standard Windows **Open** dialog. Multiple files can be selected by holding the [CTRL] key while clicking on each file.

Select the Macro Templates you wish to add and click the **Open** button.

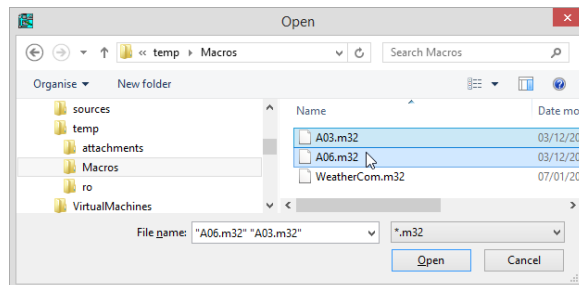

The selected Macro Templates will be imported into the selected group.

If the Macro Template already exists on the host PC, an alert box will be displayed identifying the group and subgroup of any duplicates.

If you wish to import any of the listed Macro Templates, tick the box beside its name before clicking the **OK** button. This will create a new Macro Template on the host PC, in addition to the existing duplicate.

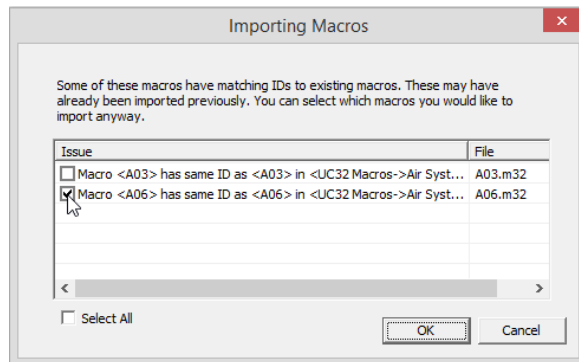

**Note:** Each newly imported Macro Template will be named “**x** New Macro”, where **x** is the index of the Macro Template in the list.

To change this name, select it in the Macro Manager dialog, and click the **Rename** button.

Once all Macro Templates have been added, they are available for use in the 'host' PC.

## WORKING WITH MACROS

To access the Macro groups and sub groups that exist in a site, click on **View Macros** in the **Strategy** tab of the **Ribbon**.

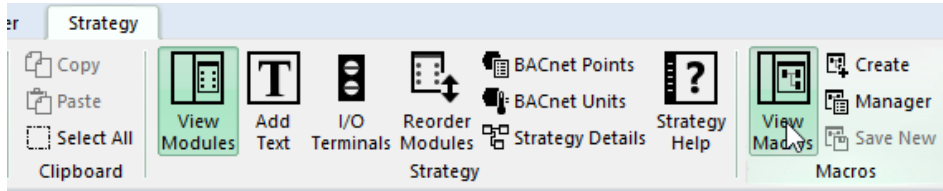

The **Macros** pane will be displayed on the right-hand side of the CXpro<sup>HD</sup> window



## HOW TO INSERT A MACRO INTO A STRATEGY

To insert a Macro in a strategy, select it in the **Macros** pane and click in the drawing area (note the cursor changes to the “Module Cursor”  during this process)

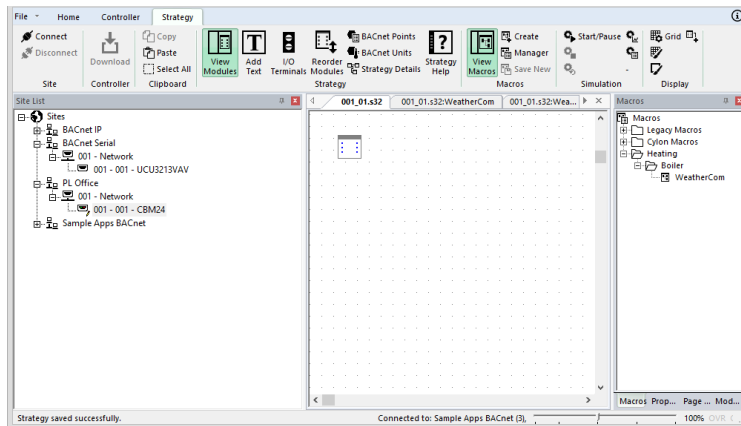

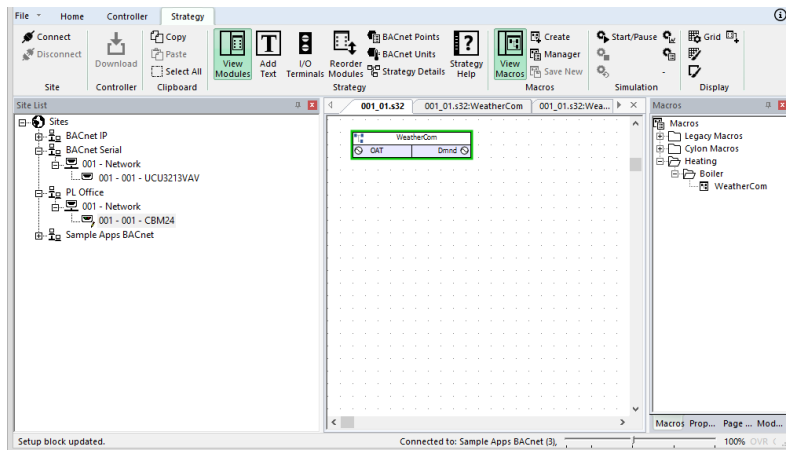
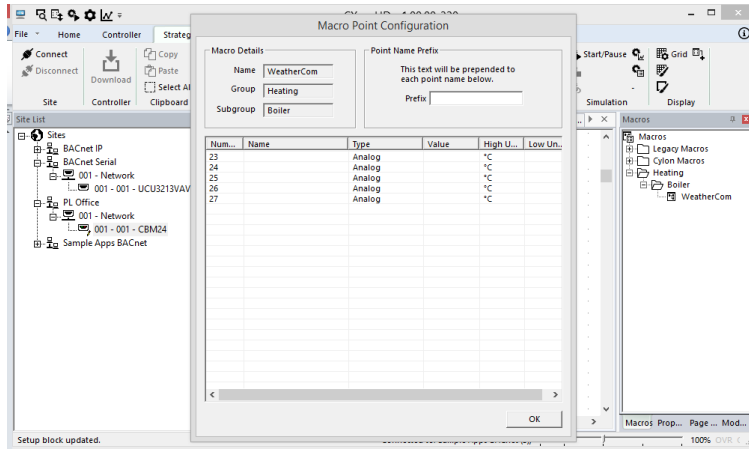

The Macro instance can be renamed, and its details viewed, through the Properties pane.

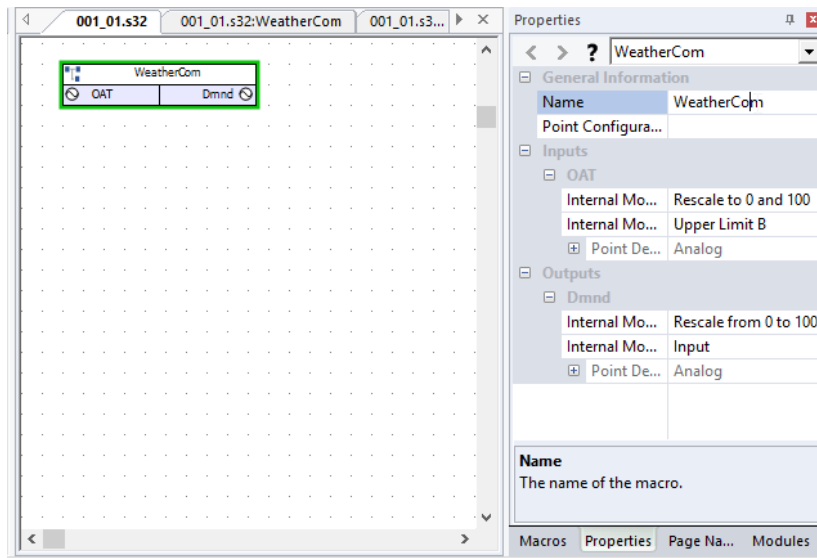

## HOW TO VIEW THE MODULES IN A MACRO ("EXPANDING" A MACRO)

To expand a Macro, double-click on the Macro symbol on the drawing area.

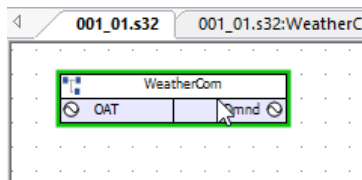

CXpro<sup>HD</sup> will open a new strategy for the Macro's constituent modules.

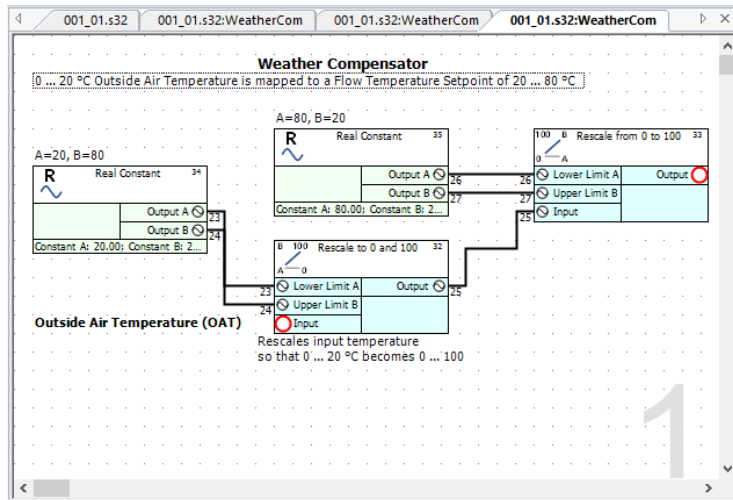

**Note:** The view settings for Lines and Point Numbers are saved with the Macro. They are not inherited from the parent strategy. For example, if lines are not visible when a Macro is expanded, simply right-click on the strategy drawing, select **Display Options**, and specify that lines are to be shown.

**Note:** To distinguish between the inputs and outputs of individual modules and the inputs and outputs of the overall Macro module red highlighting is used to mark the connection points of the Macro module. It also provides the full path of the strategy file that it just created when expanding the Macro in the **Window** menu.

**Note:** Any changes made to a macro within a strategy will only affect the current strategy. The macro and all of its module blocks are saved within the active strategy. To edit the macro strategy itself you must open the \*.etm file.



## HOW TO EDIT A MACRO

It is possible to edit an existing Macro Template or to re-save a modified Macro as a new Macro Template. To do this, expand the Macro by double-clicking on the Macro symbol in the drawing area.

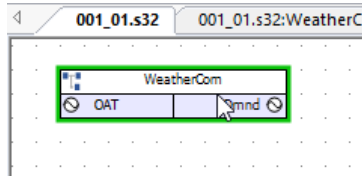

CXpro<sup>HD</sup> will open a new strategy for the Macro's constituent modules.

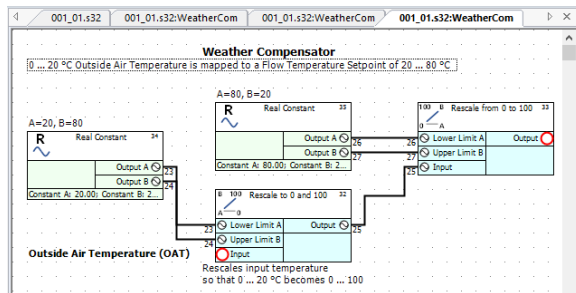

Make any required changes to the component modules of the Macro by clicking on the symbol and editing its properties in the **Properties** pane.

To save the changes select **Edit Template** from the **Macros** section of the **Strategy** tab on the **Ribbon**.

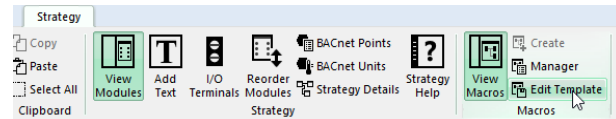

This opens the **Create Macro** dialog, but in this case, **Macro Inputs** and **Macro Outputs** cannot be added or deleted. The input and output point names can be changed, as can the **Macro Name**, **Group**, and **Sub Group**.

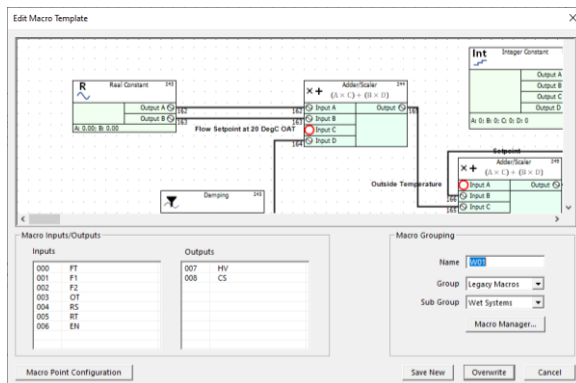

When all required changes have been made, click the **Overwrite** button to save the edits to the original template. Alternatively, if you want to retain the original template along with the edited one, edit the text in **Name** field to the name of the new template and then click **Save New**.

**Note:** This can also be launched when **Macro** is selected in the **Macro Manager**.

## 9 Communicating with Controllers

### COMMUNICATING WITH ABB CYLON<sup>®</sup> CONTROLLERS

When you are using CXpro<sup>HD</sup>, you will need to communicate with the **ABB Cylon<sup>®</sup>** controllers on the site.

- You may need to **send** information **to** a controller such as a control strategy, a command to erase its memory, details of its setup, etc.
- You may need to **get** information **from** a controller such as its version, current setup, and details of any strategies it may contain.
- You may wish to view events **within** a controller, such as changes in values when a strategy is being serviced. This can be done in **Scan** mode or by using the **LiveLog** menu option.

### SENDING INFORMATION TO A FIELD CONTROLLER

When the strategy is ready to be downloaded, simply click the download button on the toolbar or choose **Download** from the **Communications** menu and CXpro<sup>HD</sup> will download the strategy and send the set-up automatically.

### WIPING A FIELD CONTROLLER'S MEMORY

Although it is no longer necessary to wipe the Field Controller's memory before downloading if automatic download is enabled, it is still necessary to wipe the controller's memory before using it for the first time. If you are not using automatic download, you must manually wipe the controller's memory before downloading.

The effect of wiping a Field Controller's memory

Wiping Field Controller memory has the following effect:

- All blocks are deleted (the strategy is deleted).
- The functions of the site (valves, pumps, dampers, etc. controlled by this Field Controller, are no longer available.)
- The number of serviced blocks will be set to zero. Field Controller Set-up has to be sent again.
- All virtual points are assigned the value zero.
- All hardware points are assigned the value zero.
- All outputs go to zero volts.
- Inputs do not read any signals from connected devices. This is true for manually overridden points too.
- The green LED on the Field Controller flashes rapidly. If the Field Controller is running without a network (standalone), the flashes are regular. If the Field Controller is running on a network (connected to a BACnet Router), the flashes are irregular.
- If the alarm feature is active, an alarm appears on the monitor of the connected PC.
- If a keypad program for that Field Controller exists, it will be deleted.

### SENDING THE SETUP TO A FIELD CONTROLLER

If you are using **Automatic Download**, it is not necessary to send the setup to the controller after downloading. Otherwise, the setup must be sent manually as described in *Starting a strategy (sending the Setup)* on page 120.

## GETTING CONTROLLER INFORMATION

### HOW TO GET THE CONTROLLER VERSION

- Select the controller in the **Site List**
- Connect to the controller by clicking on the **Connect** button in the **Home** tab of the **Ribbon**:

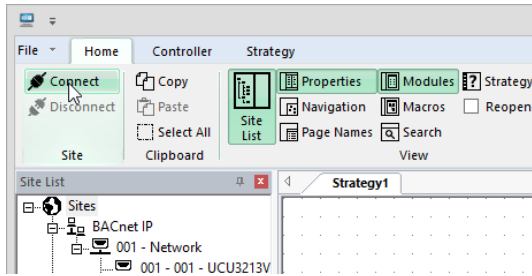

- Select Version from the Operations section of the Controller tab in the Ribbon.

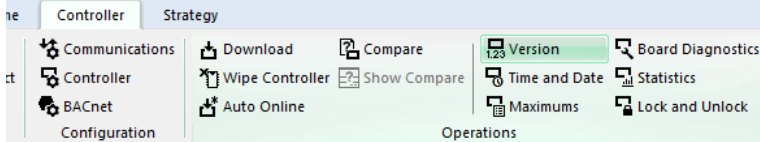

CXpro<sup>HD</sup> will get the version from the controller and display it.

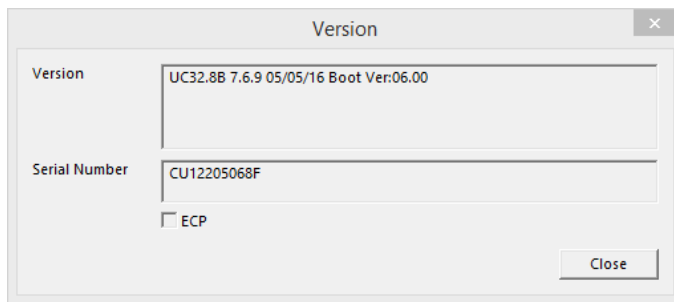

Click **OK** to close the **Version** window.

## HOW TO GET THE CONTROLLER SETUP

- Select the controller in the Site List
- Connect to the controller by clicking on the Connect button in the Home tab of the Ribbon:

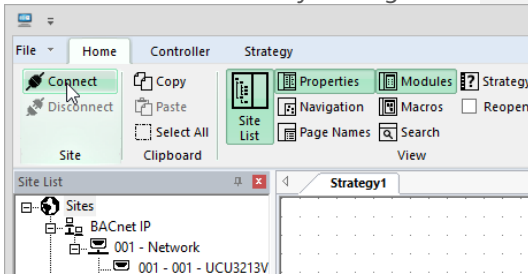

- Select Time and Date from the Operations section of the Controller tab in the Ribbon.

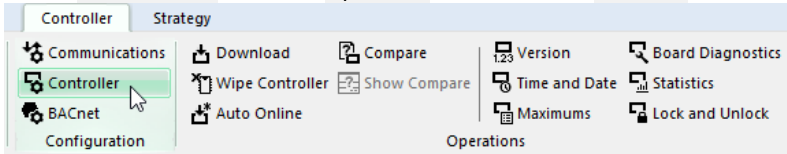

CXpro<sup>HD</sup> will get the Setup of the controller and display it.

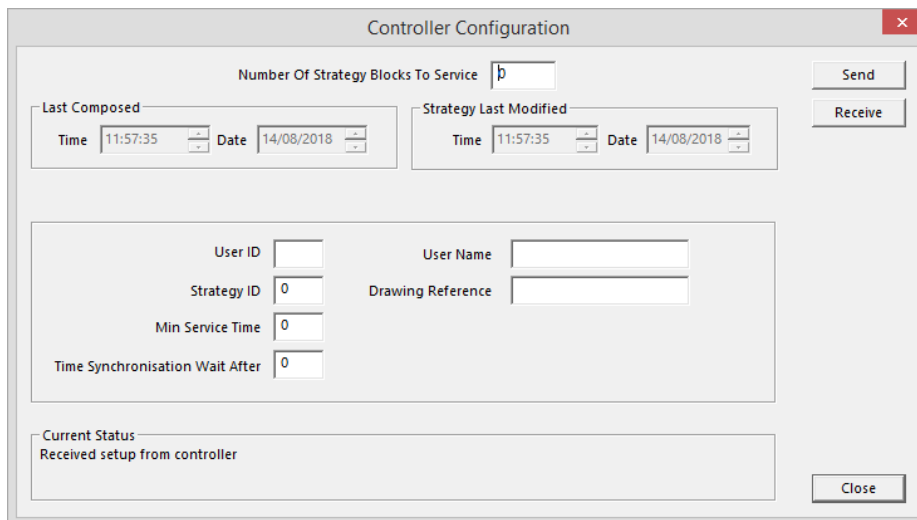

Click **OK** to close the **Time and Date** window.

## HOW TO GET CONTROLLER STATISTICS

- Select the controller in the Site List
- Connect to the controller by clicking on the Connect button in the Home tab of the Ribbon:

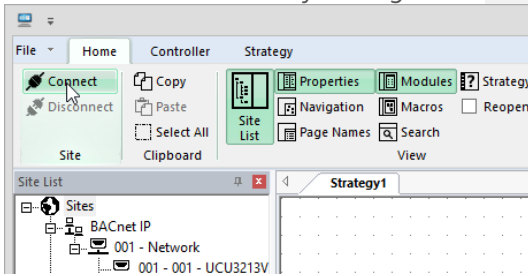

- Select Statistics from the Operations section of the Controller tab in the Ribbon.

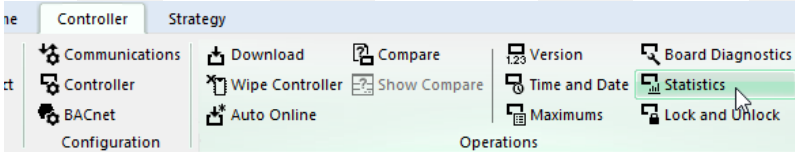

The Statistics dialog box, shown below, appears. The Statistics dialog box contains information that comes directly from the controller – this information allows you to check the status of the controller.

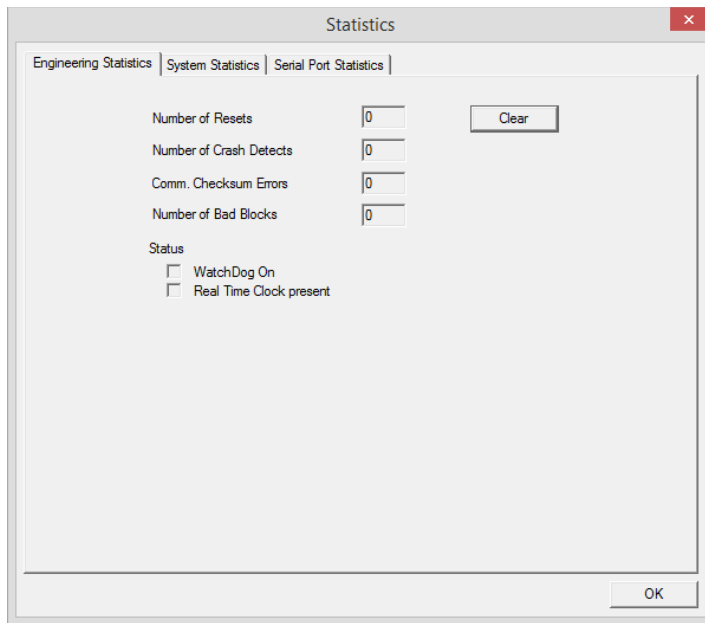

The Statistics dialog box has three tabs – Engineering Statistics, System Statistics, and Serial Port Statistics.

## Engineering statistics tab

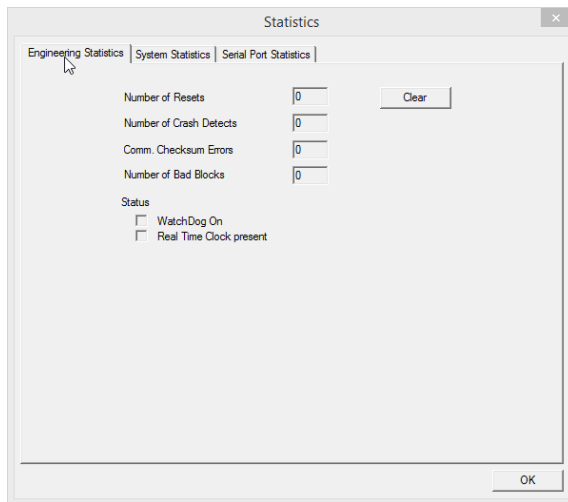

**Number of resets** indicates how many times the Field Controller has been powered up and down

**Number of crash detects** the number of crash events detected since the strategy started

**Comm. Checksum errors** the number of data errors that have occurred in communications

**Number of bad blocks** the number of bad or corrupted blocks that have been detected in the strategy

**Watchdog on** This shows the current status of the “Watchdog” on the Field Controller – the box is checked if the watchdog is switched on (a watchdog is a hardware component in the controller that checks if the controller is serviceable. When the watchdog is off, the controller is not operating)

**Real time clock present** indicates if a real time clock is present in the Field Controller

## System statistics tab

This tab provides information on any problems the controller may have in servicing the strategy.

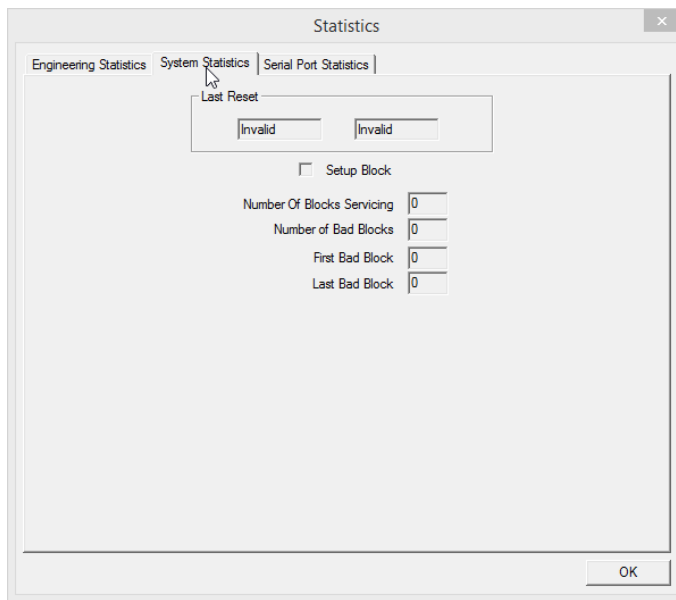

**Last reset** Shows the date and time that the Field Controller was last reset

**Set-up block** indicates if the Setup block (the block in the controller that stores details of the number of blocks in the strategy) is in place.

**Number of blocks servicing** shows how many blocks are servicing in the Field Controller

**Number of bad blocks** shows how many bad or corrupted blocks are detected in the Field Controller

**First bad block** The number of the first of the bad blocks (if any)

**Last bad block** The number of the last of the bad blocks (if any)

## Serial Port Statistics tab

CXpro<sup>HD</sup> can display information about messages passing through the Field Controller's serial ports as follows:

The first section of this panel, **Serial Port Type** allows you to select which of the four possible serial ports the displayed information refers to.

Pressing the **Receive** button causes CXpro<sup>HD</sup> to upload information about the selected port from the Field Controller.

Clicking on **Clear** causes the Field Controller to clear its memory of port statistics for the selected port.

The information displayed is the number of each of the following messages that passed through the selected serial port since the controller's memory was last cleared:

- Number of Bytes received
- Number of Bytes Sent
- Number of Packets received
- Number of Packets Sent
- Number of NACKs received
- Number of NACKs sent
- Number of ACKs received
- Number of ACKs sent
- Number of Checksum errors
- Number of Overrun errors
- Number of Framing errors
- Number of Parity errors
- Number of break conditions

This information can be used to diagnose low-level problems with the Field Controller's serial-port communications, and this is usually done in consultation with **ABB Cylon**<sup>®</sup> Technical Support.



## HOW TO GET FIELD CONTROLLER DIAGNOSTIC INFORMATION

CXpro<sup>HD</sup> has a facility to display information about the operation of the UC32 controller's hardware system. This information referred to as 'board diagnostics' can be of use in troubleshooting unusual and low-level problems on a **ABB Cylon**<sup>®</sup> site, and is intended for use primarily when communicating with **ABB Cylon**<sup>®</sup> technical support.

Board Diagnostic information may be viewed by selecting **Diagnostics** from the **Controller** tab on the **Ribbon**.

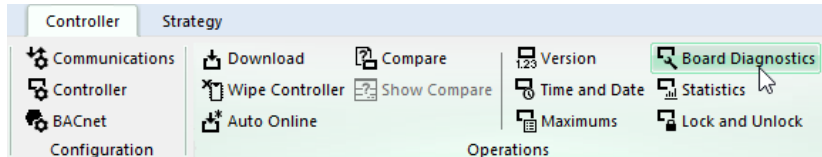

This opens a display panel showing categories of information about the Field Controller's hardware.

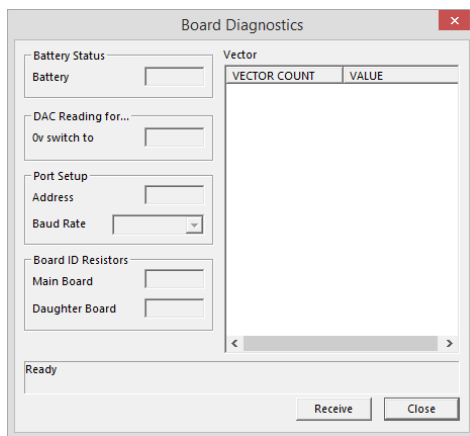

Clicking on the **Receive** button causes CXpro<sup>HD</sup> to upload the relevant information from the targeted Field Controller.

## HOW TO GET FIELD CONTROLLER CONFIGURATION INFORMATION

Field Controller configuration information can be of use in troubleshooting unusual and low-level problems on a **ABB Cylon**<sup>®</sup> site and is intended for use primarily when communicating with **ABB Cylon**<sup>®</sup> Technical Support.

To view this information, select **Maximums** from the **Controller** tab of the **Ribbon**

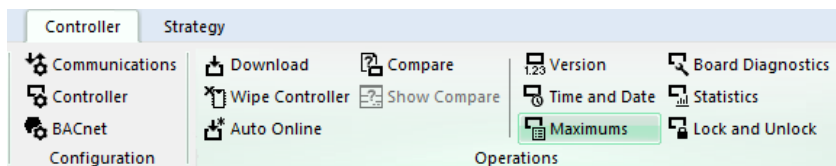

This opens a display panel showing the configuration of the Field Controller's hardware.

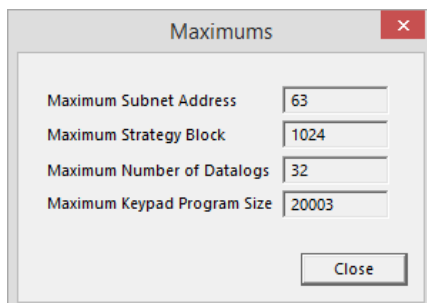

## HOW TO SET THE CONTROLLER TIME AND DATE

- Select the controller in the Site List
- Connect to the controller by clicking on the **Connect** button in the **Home** tab of the **Ribbon**:

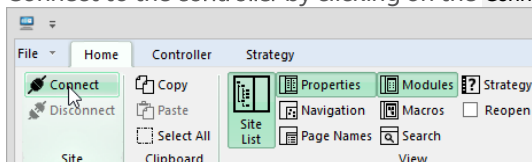

- Select **Time and Date** from the **Operations** section of the **Controller** tab in the **Ribbon**.

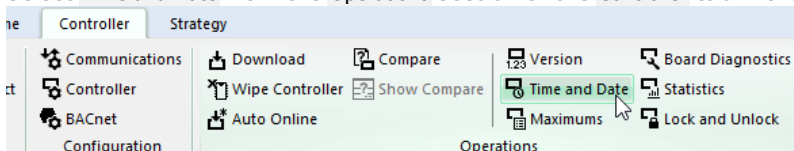

This opens the **Time and Date** dialog.

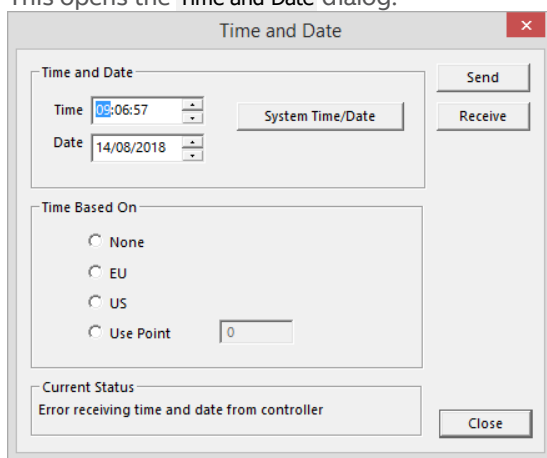

In this dialog, you can check the time and date set in the targeted **controller** by clicking on the **Receive** button (time and date are automatically received when you first open the dialog).

The **Time** and **Date** can be changed by typing a new date, by scrolling, or by pressing the **System Time / Date** button, which sets the time and date to match the settings in the PC on which **CXpro<sup>HD</sup>** is running.

The daylight saving time scheme can be selected in the **Time based on** the box on the **Time and Date** dialog:

- If the **None** option is selected for Daylight Savings, then the controller will not automatically adjust its time to match conventional **Summertime** and **Wintertime**.
- If the **EU** option is selected for Daylight Savings, then the controller will automatically adjust its time according to the standard European rules for **Summertime** and **Wintertime**.
- If the **US** option is selected for Daylight Savings, then the controller will automatically adjust its time according to the standard rules used in the USA for **Summertime** and **Wintertime**.
- If the **Use Point** option is selected for Daylight Savings, then you can specify a point whose value will determine **Summertime** and **Wintertime**.

If the time and date settings have been changed in the dialog box, they must be sent to the controller before they will take effect. This is done by clicking the **Send** button:

Clicking the **Close** button closes the dialog box without sending or receiving further information.

## CHANGING THE ADDRESS OF A CONTROLLER (CBM ONLY)

CBM controller addresses must be set from software because there are no Address DIP switches on this type of controller. To set a controller's address from CXpro<sup>HD</sup>:

- Make sure that the PC, running CXpro<sup>HD</sup>, is directly connected to the Field Controller's service port.
- Make sure that there is a site set up in CXpro<sup>HD</sup> with the PC connected to COM port:

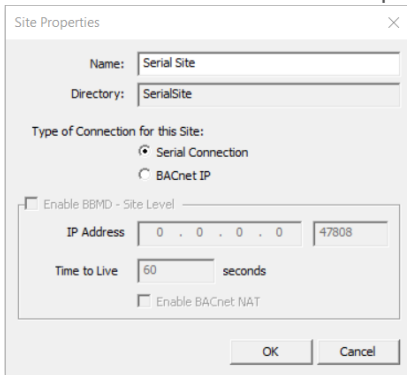

- Make sure that the directly connected controller is targeted in CXpro<sup>HD</sup>'s Site List

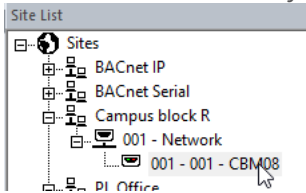

- Connect to the controller by clicking on the Connect button in the Home tab of the Ribbon:

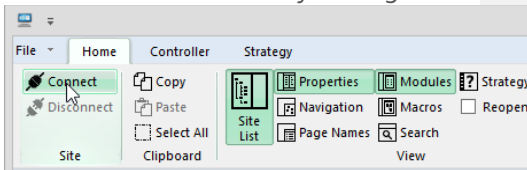

- Select BACnet from the Configuration section of the Controller tab in the Ribbon

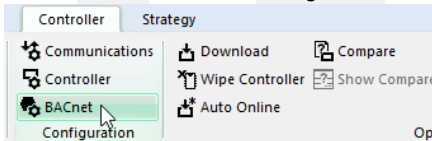

- In the BACnet Configuration dialog, you can set the address for the controller

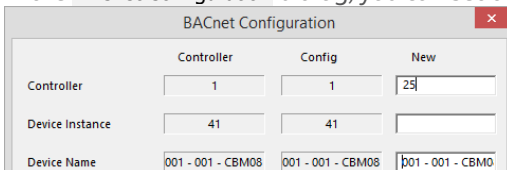

# 10 Datalogs and Alarms

## DATALOGS

Datalogs (Trendlogs) are a feature of Field Controllers that allows point values to be recorded over a period of time. The recorded data can be later retrieved, displayed, and analyzed with the **Datalog Manager** module.

Analysis of logged data is often useful in optimizing the effectiveness of an **ABB Cylon**® site's controllers and strategies, and Identifying opportunities for energy savings.

## THE DATALOG FUNCTION MODULE

The collection of point values in a datalog is implemented in a strategy by either the Datalog module or the BACnet Trendlog module.

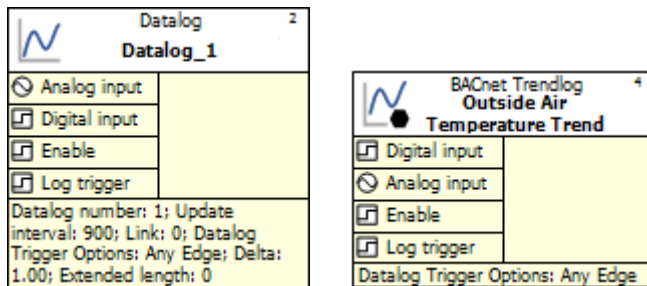

The content of a Datalog can be viewed with the CXpro<sup>HD</sup> Datalog Manager, and the content of a BACnet Trendlog can be examined by a BACnet supervisor. Their use in the strategy is identical.

## RESTRICTIONS ON THE USE OF DATALOGS

The number of Datalogs (Trendlogs) permitted in a strategy depends on the type of controller in which the strategy will be used.

Some controllers, such as the **CBM24** can have up to 32 datalog, with a maximum of 1024 entries per datalog. Other controllers, such as the **CBT12**, have up to 6 datalog, with a maximum of 1024 entries in each. You can determine the number of datalog that a particular controller can hold using the **Maximums** dialog box, available from the **Operations** section of the **Controller** tab on the **Ribbon** menu.

## STANDARD DATALOG SAMPLING PERIOD

Each standard datalog module can be configured with an individual time constant for sampling data. To make the evaluation of datalog easier it is advisable to use the same time period for sampling data in all datalog modules. A sampling period of 15 minutes is suggested.

The period of time over which the datalog samples are equal to the product of number of entries (104 or 192) and the sampling frequency. For example, a datalog module on a UC16PG with a sampling frequency of 15 minutes (900 seconds) will take samples for (192 X 15) minutes = 48 hours.

## TIME STAMPED DATALOGS

A time-stamped datalog records the time and date at which a value was recorded, along with the value. A logging interval is not set - instead, the value of the specified point is recorded:

- when the digital trigger point changes state
- when a logged digital point changes state
- or when a logged analog point changes state by more than a predefined amount from the last value that was logged for it.

There are several situations when such a datalog would be particularly useful. For instance, if you log the value of a point with a conventional datalog and set the logging interval to 10 minutes, the value of the point may change significantly and return to its original value over a period of 3 minutes, and that change might occur during the 10 minutes when the datalog is not recording. If so, the event would not be logged at all. On the other hand, if the logging interval was 30 seconds, the event would be recorded - but the datalog could fill up and the event could be 'flushed' before it is viewed. If so, the event would also be lost. In both of these cases, a time-stamped datalog could record data over the period of the event only, so that the necessary data is recorded without the datalog filling up.

The other primary use of a time-stamped datalog is to log conditions that surround an event. For instance, when a window is opened, the temperature of the surrounding area could be logged to see how it reacts.

### DATALOG SAMPLING OF DIGITAL AND ANALOG POINT VALUES

Both digital and analog point values can be sampled. The datalog module has a digital input and an analog input.

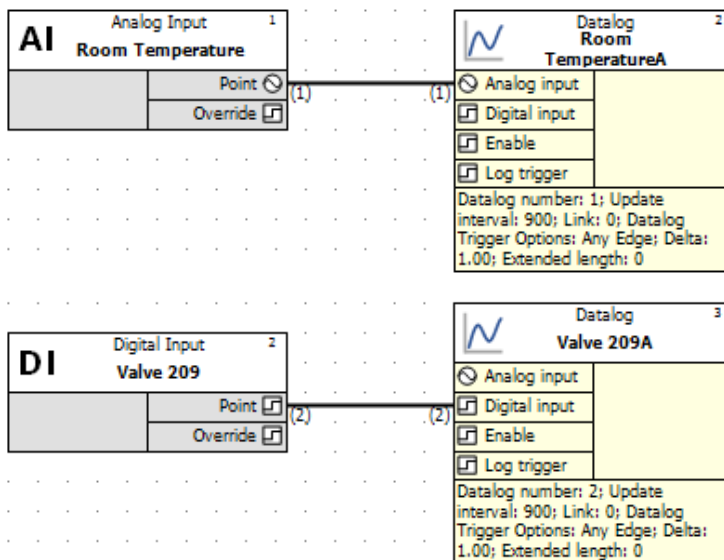

### HOW TO DEFINE A DATALOG

To define a datalog, proceed as follows:

Select the Datalog module in the Modules pane

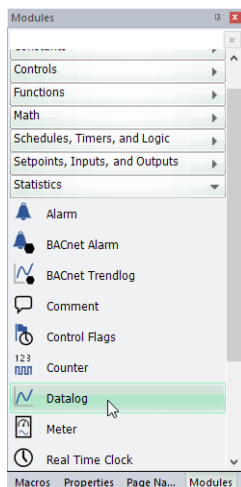

and place it on the drawing area (note the cursor changes to the “Module Cursor”  during this process)

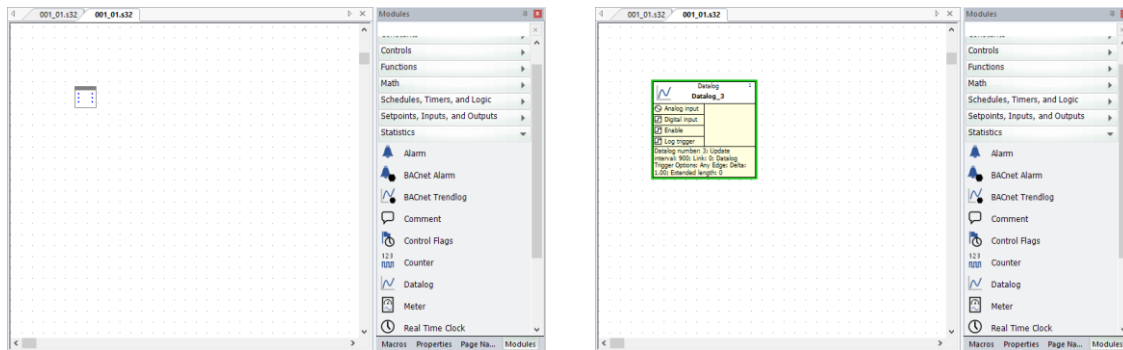

Select the datalog, and configure its properties

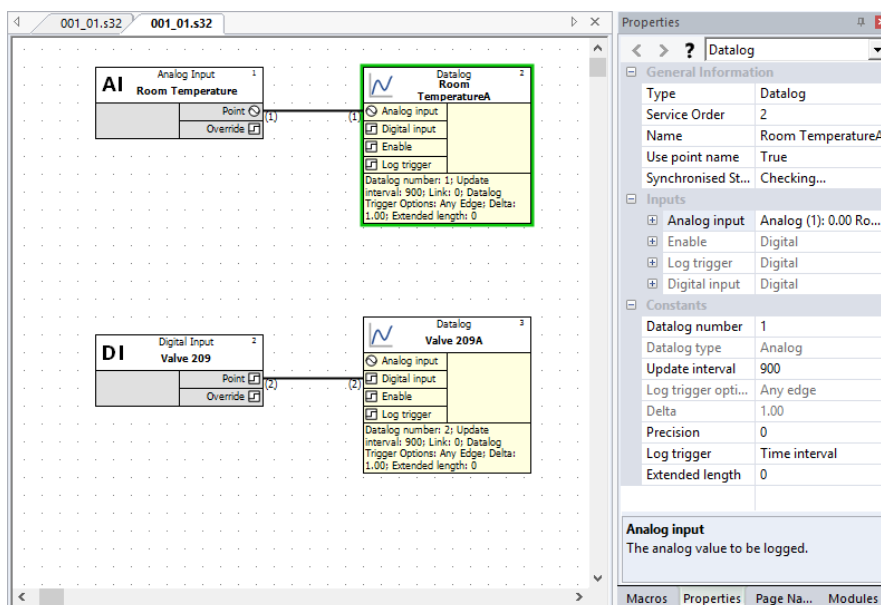

## Name

A datalog is automatically given the same name as the point to which it is joined but can be edited if the **Use Point name** property is set to **False**.

## Use Point name

If **True**, then the **Name** property matches the connected point and cannot be edited.

## Analog input

This shows details of the point to be logged if an Analog point is connected

## Enable

The Enabling Point is a digital point, connected to the “Enable” input of the datalog module, which restarts the sampling process if its value changes from 0 to 1. If this point is not connected, then the datalog samples continuously. In typical applications, this input is not used.

## Log Trigger

In Time-stamped datalogs, it is possible to record data when this trigger point changes. If the trigger point is not connected, logging occurs according to the '**Minimum Change**' parameter.

## Digital input

This shows details of the point to be logged if a Digital point is connected

**Datalog Number**

This shows the automatically-assigned number for the Datalog within the strategy.

**Datalog Type**

The type (analog or digital) of the point being sampled is shown in the Type of Point to Log.

**Update Interval**

This is the frequency of sampling (in seconds). By default, this is 900 (15 minutes) but can be edited in the Properties pane.

**Delta**

If the datalog type is set to 'Time Stamped', and if the type of point being logged is analog, it is possible to trigger a sample whenever the point value changes by more than a particular amount. This field specifies that amount of change.

**STARTING A DATALOG**

A datalog is part of a strategy and is saved with the strategy. The example below shows a datalog module linked to a strategy:

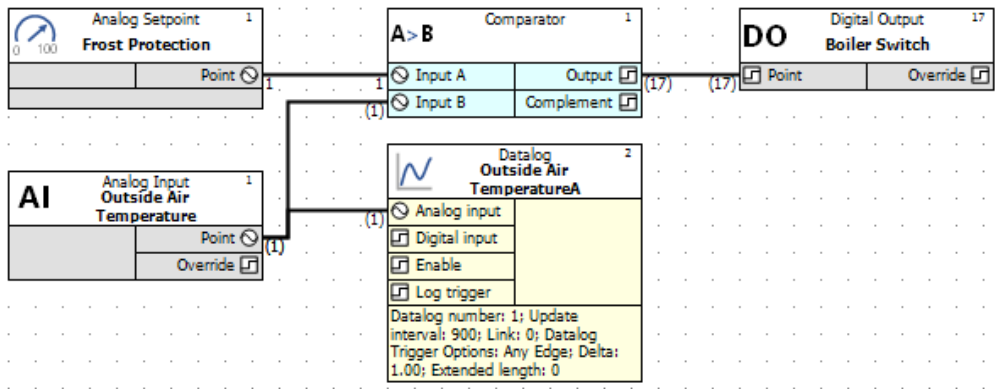

Datalogs are started along with the rest of the strategy in which they are contained, when the strategy has been saved (see page 110), downloaded (see page 115), started (see page 120) and tested (see page 122).

**Note:** If the block on which a datalog module is placed is downloaded again to the Field Controller, the sampled data is deleted.

## VIEWING THE CONTENTS OF A DATALOG

This is done on a PC running CXpro<sup>HD</sup> software.

The **Datalog Manager** program is used to view or print out datalogs, on screen or printer, as text or graphics. To open it, click on the **Datalog Manager** icon in the **Home** tab of the **Ribbon**.

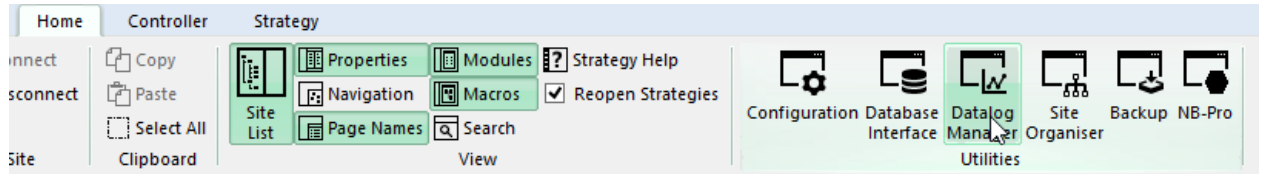

The **Datalog Manager** allows data from Field Controller datalogs to be viewed in a variety of ways:

- The data can be listed as text.
- A datalog can be viewed as a graph.
- Information from multiple datalogs can be superimposed on one graph.
- The status of data points can be viewed in real-time.
- 'Snapshots' can be made of data from any set of analog points in a controller strategy.

For further details on the display and printing of datalogs, see the *Datalog Manager* manual.

Archived datalogs can be statistically evaluated by using programs like Microsoft Excel. This provides valuable information about the operation of the site.



## ALARMS

Alarms are used in a BMS system to alert site supervisors/engineers to any difficulties that may occur on a Site. The **ABB Cylon**<sup>®</sup> BACnet range supports BACnet Alarm notifications which can be made available to BACnet supervisors such as Cylon's **Aspect**<sup>™</sup> UI.

The BACnet Alarm module is joined to a digital point (Binary Value). When the digital point has the value 1, the BACnet Alarm module is activated. The Binary Value may indicate an error condition, for example, a sensor going out of normal range or a fire alarm being activated.

Alarms can also be set up directly on BACnet points via standard BACnet protocol.

### STARTING ALARMS

Alarms are parts of strategies and are saved with the strategies. The examples below show how alarm modules can be linked to a strategy.

Alarms are started after the related strategies have been saved, downloaded, started, and tested.

### EXAMPLES OF STRATEGIES CONTAINING ALARMS

#### Alarms - Example 1: Pump Trip Switch

To illustrate the use of an alarm module in a strategy, this guide takes as an example a simple case where a digital hardware input represents a trip-switch contact of a pump. Joining the digital input to an alarm module means that an alarm will be generated if the pump goes off-line.



#### Alarms - Example 2: Pump Trip Switch with delay

This case joins a digital virtual point (a delay of 60 seconds on the digital hardware input) to the alarm record function module.

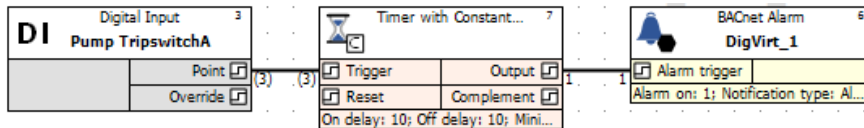

#### Alarms - Example 3: Room Temperature Input

In this case, an analog input (room temperature) is joined to the alarm record function module and will cause an alarm to be sent to the Alarm Handler program if the input value is not within the range specified in the real constant module.

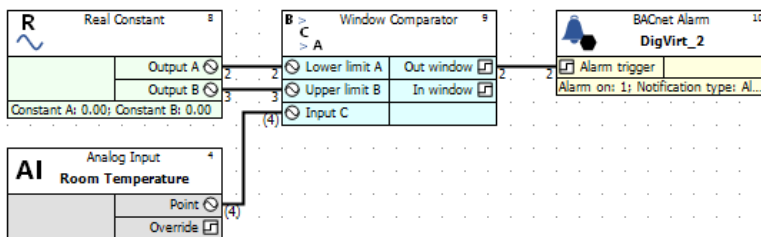

# 11 Simulation Mode

## INTRODUCTION

A **Simulation Mode** is available within CXpro<sup>HD</sup>, which allows the operation of a strategy to be simulated without the requiring a controller to be connected. This is done, in most cases, by using actual Firmware code to ensure the simulation is as close as possible to real controllers.

Simulation Mode is accessed through the **Simulation** section of the **Strategy** tab on the **Ribbon**

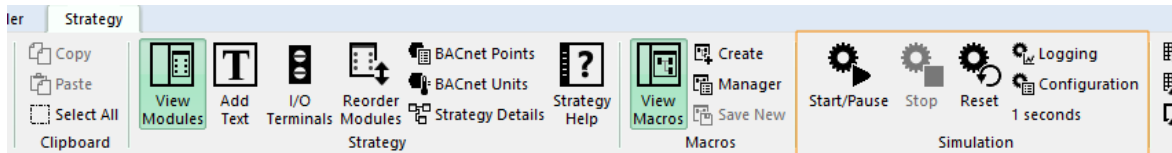

Clicking this button will start and pause the simulation for the current strategy. It is enabled only if CXpro<sup>HD</sup> is **not** logged into the site. When the strategy is paused, the current simulation state is still visible on the strategy.



Clicking this button will stop the simulation and clear the simulation information from the screen. However, the simulation state will still be preserved, and pressing the **Start/Pause** button will restart from where it stopped.



Clicking this button will stop the simulation, clear the simulation information from the screen, and clear any other simulation information for the strategy.

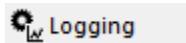

Clicking this button will enable or disable logging of data. When released, no point logging will happen. When pushed, any point that has logging information set will have its values logged accordingly.

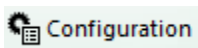

Clicking this button opens the **Simulation Configuration** dialog.

## CONFIGURING THE SIMULATION

Several aspects of the Simulation can be configured by pressing the  **Configuration** button the **Simulation** section of the **Strategy** tab on the **Ribbon**. This opens the **Simulation Configuration** dialog.

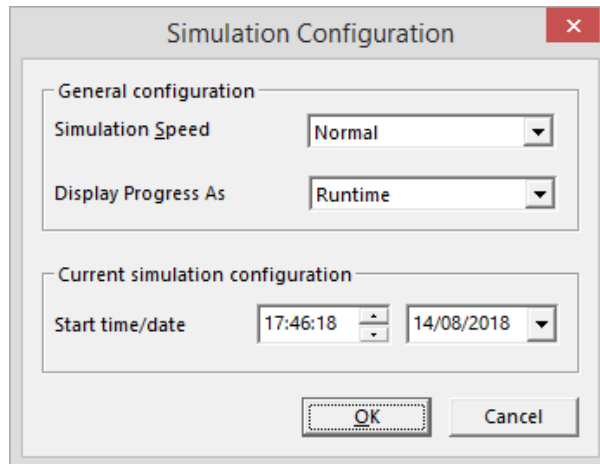

## THE SIMULATION CYCLE

The basic unit for simulation is a **Simulation Cycle**. This corresponds to approximately 1 second of runtime on a controller. Some modules (Hardware, Globals, time dependent modules) will be processed a fixed number of time during a cycle. Most of the other modules will be processed a number of times that depends on the size of the strategy. The bigger the strategy, the less the modules will be processed.

### Simulation speed

The Simulation can be run manually (“Step by Step”) where each click on the start button runs one Simulation Cycle, or automatically at one of 3 speeds: **Slow** (once cycle every 5 seconds), **Normal** (one cycle per second) or **Fast** (5 cycles per second).

### Display Progress As:

The progress of the current simulation is displayed in the right-most section of the Simulation Toolbar. This progress can be displayed as **Runtime** (number of seconds since the simulation started) or **Date/Time** (current simulation date and time)

## CURRENT SIMULATION CONFIGURATION

### Start time/date:

When the Simulation Cycle is run, any time and date dependent modules – such as Time Schedules or Datalogs/Trendlogs - will use a simulated time. The value used will be the time and date set in the **Current simulation configuration Start time/date** field of the **Simulation Configuration** dialog, incremented by one second on each Simulation Cycle.

This allows a strategy to be tested for unusual behaviors at specific times such as daylight savings time, year-end, leap years, etc.

The value of this time and date will be displayed in the right-most section of the **Simulation Toolbar** if the **Display Progress As** field is set to **Date/Time**.

## RUNNING A SIMULATION

When a Simulation runs, the labels at the end of lines will be updated to show the point values.

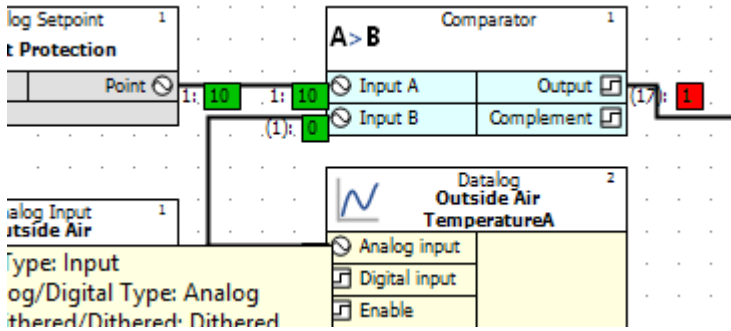

A green background means that the value is calculated by the simulation.

A red background indicates that the value has been overridden by the user.

**Note:** It is possible to add, update, and delete modules and lines while the simulation is running. The simulation will take it instantly into account in its calculations.

## LIVELOG

During a simulation, the livelog will display values from a simulation run so that it is possible to viewpoint values from different parts of the strategy simultaneously.

## POINT PROPERTIES

The Simulation mode has two sets of point properties:

- one for input points that feed into the strategy (hardware inputs and Globals' destinations),
- one for all the other points whose values result from the strategy's internal calculation.

## ACCESSING THE POINTS PROPERTIES

To open the Simulation Properties for a specific point right click and select **Simulation properties**. This can be done on either Lines, Hardware I/O modules or connected nodes:

### Lines

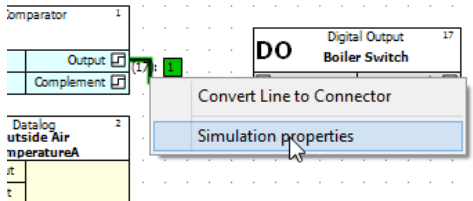

### Hardware I/O modules

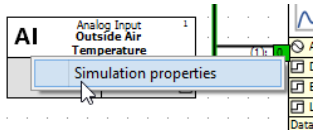

### Connected nodes

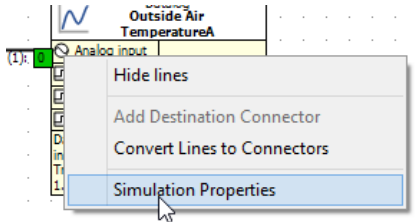

## POINT VALUE OVERRIDE

In a point's **Simulation** properties dialog you can specify whether the value for the point will be calculated by the Simulation, or set to a fixed value:

Analog points:

Point calculated automatically:

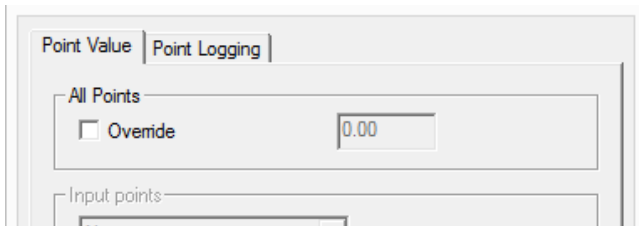

Point is overridden and set to 18.5:

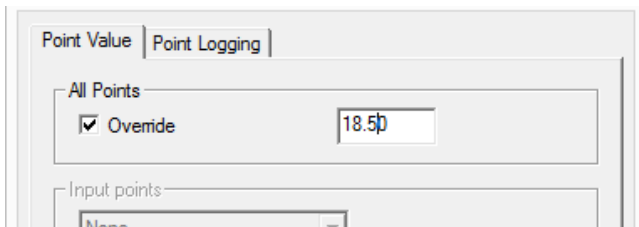

Digital Points:

Point calculated automatically:

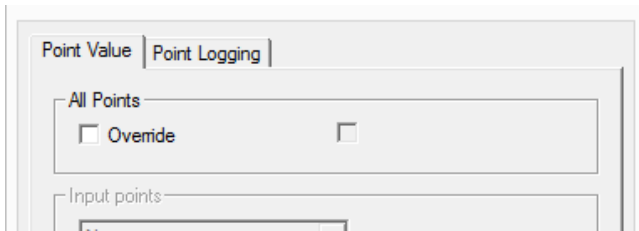

Point is overridden, and set to "off" (boolean 0)

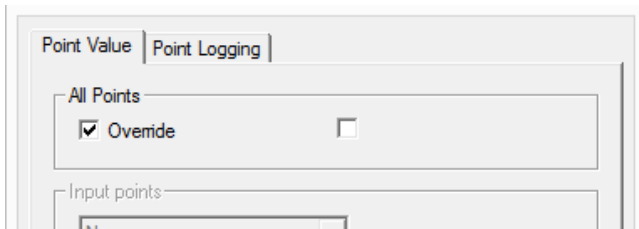

Point is overridden, and set to "on" (boolean 1)

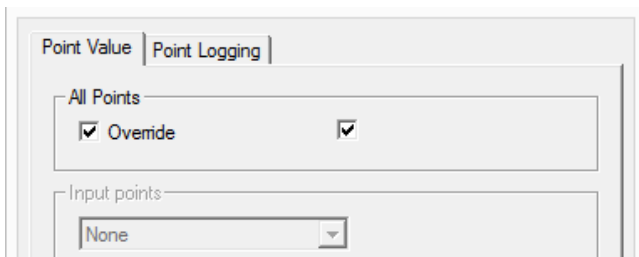

## INPUT POINT OPTIONS

For an input point, a selection of options is available to simulate different types of inputs. For Digital points there are two options, for Analog points there are 7:

### Digital Input point options

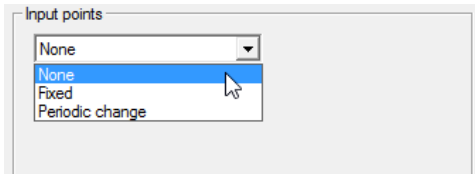

#### Fixed value

The point will have a fixed value throughout the Simulation run.

Value is “Off” for the whole Simulation run:

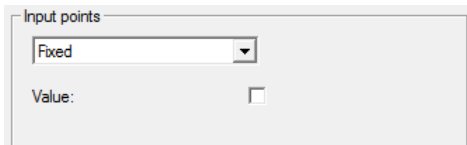

Value is “On” for the whole Simulation run:

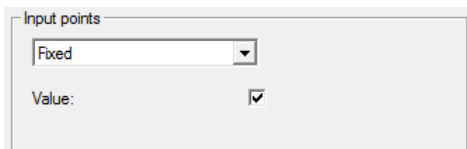

#### Periodic change

This option will change the value of the digital point during the Simulation run.

If the **Random period** box is unchecked, the value will change after the **Basic Period** specified:

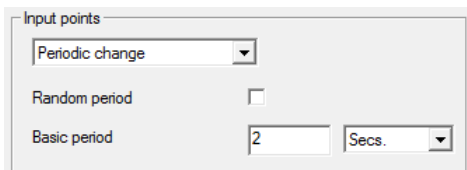

If the **Random period** box is checked, the value will change after a random period which is less than the specified **Basic Period**:

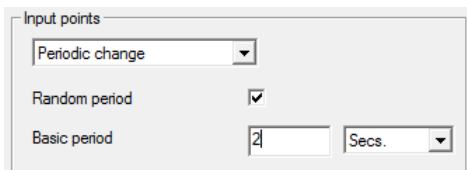

Analog Input point options:

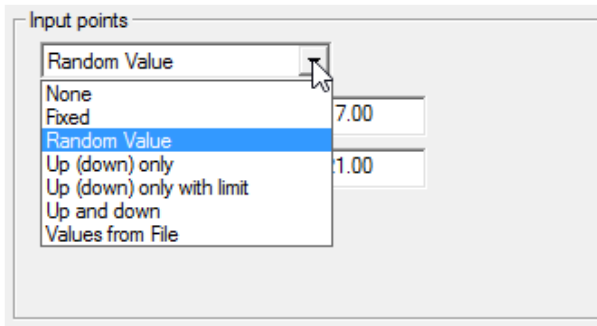

**None**

The point is not assigned a value. The value will either be the last value that the point had, or zero if no previous value existed.

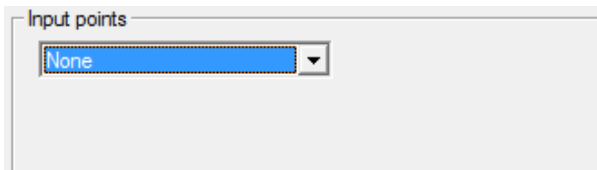

**Fixed**

The point will have a fixed value throughout the Simulation run.

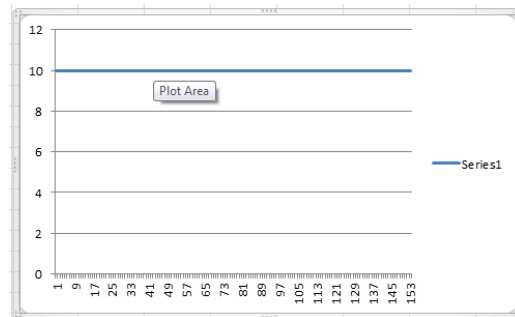
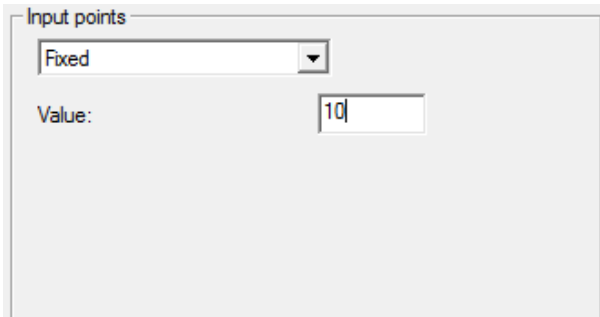

**Random value**

During each simulation cycle, the point will be assigned a random value between a given minimum and maximum.

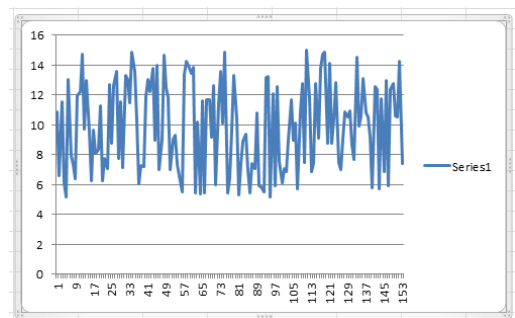
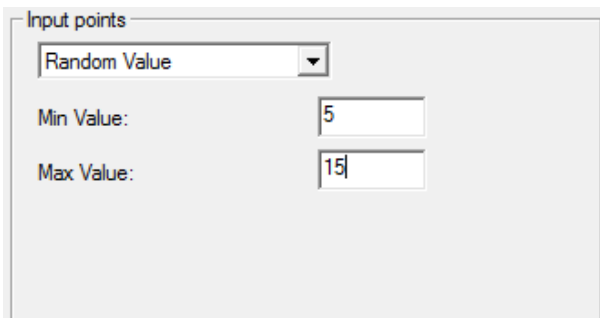



### Up (down) only

The value will change in only one direction (up or down). Use a negative step limit to go down.

Input points

Up (down) only

Start value 5

Fixed step 1

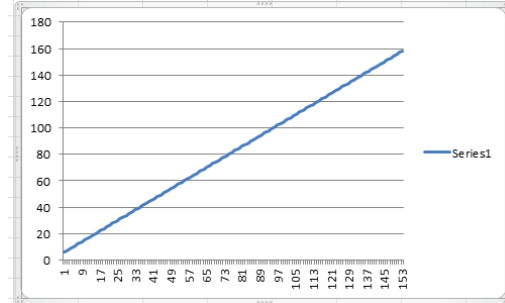

Input points

Up (down) only

Start value 5

Random step up to 1

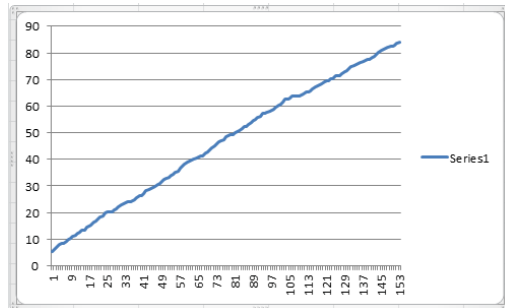

### Up (down) only with limit

The value will go from a Start value to a Stop value.

Input points

Up (down) only with limit

Start value 5

Stop value 100

Fixed step 3

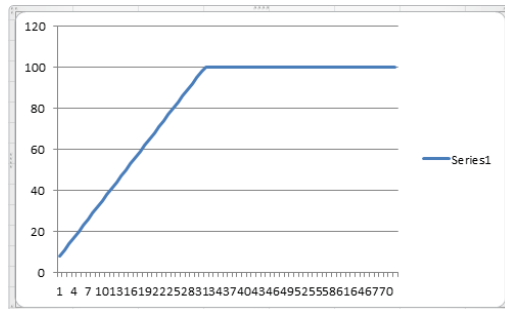

Input points

Up (down) only with limit

Start value 5

Stop value 100

Random step up to 3

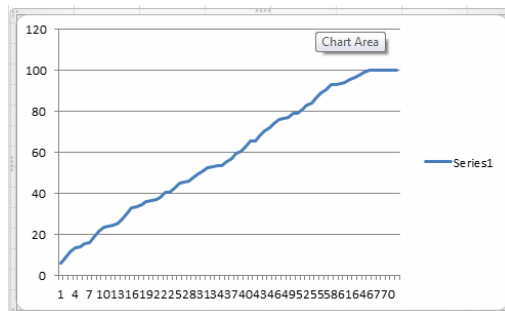

### Up and down

The value will go up and down continuously between two limits either by a specified step (fixed or random) with a specified period (specify the time to go from one limit to the other).

Input points

Up and down

Start value: 15

Stop value: 25

For up to: 0 None

Fixed step: 0.5

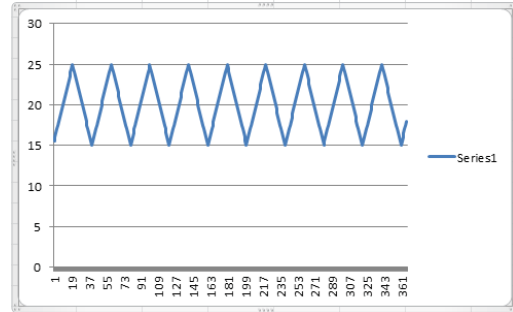

Input points

Up and down

Start value: 15

Stop value: 25

For up to: 0 None

Random step up to: 0.5

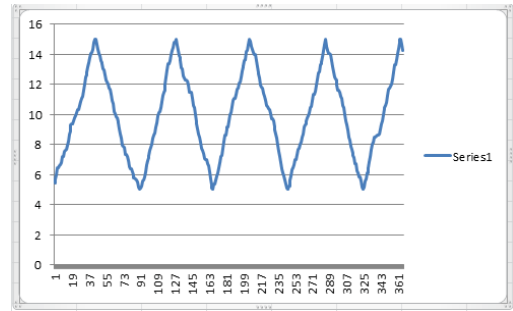

Input points

Up and down

Start value: 15

Stop value: 25

For up to: 1 Mins.

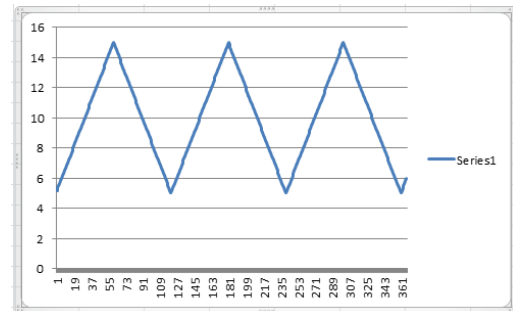

### Values from file

The point value will be taken from a datalog file – at each simulation cycle, the next value will be read from the file.

This allows using real data such as a datalog of outside air temperature in the simulation. It also makes it possible to repeat a simulation exactly if the input points from the original simulation have been logged.

Input points

Values from File

File: [ ] [ ]

## POINT LOGGING

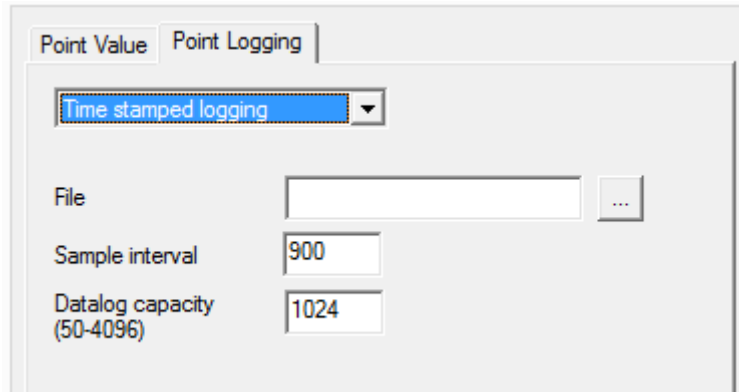
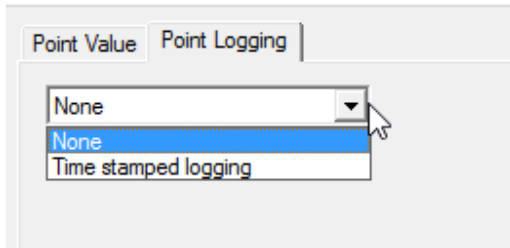

Any point in the strategy can be logged to a file. This can be used to review values after the strategy has run, and analyze issues. It can also be used to feedback the value in another simulation (see “Input points options”).

**Note:** Logging will occur only if both

1. the settings in the point Simulation properties dialog are set and



2. the logging button **Start/Pause** is pressed in the **Simulation** section of the **Strategy** tab on the **Ribbon**.

This means that logging can be switched on or off during a simulation by clicking the logging button.

## 12 Sites

### OVERVIEW

A site is the name given to one or more controllers, optionally connected to a PC. The following are examples of sites.

- A standalone Field Controller.
- One BACnet Router with a Fieldbus of one or more Field Controllers
- A network of BACnet Routers, each with a Fieldbus of one or more Field Controllers, connected to each other via TCP/IP.

Sites are configured in the **Configuration** program.

Some common procedures carried out on sites include:

- Installing a new site on the PC (see page 180)
- Site backup (see page 180)

### INSTALLING A NEW SITE ON THE PC

To install a new site on a PC, the CXpro<sup>HD</sup> must be installed already.

A new site is one which has not been installed on this PC before, and for which a backup from another PC does not exist.

### WHAT HAPPENS WHEN A NEW SITE IS INSTALLED

Installing a new site involves the following events:

- Site-specific directories are created on the hard disk.
- Site-specific information (information about network ID, telephone number, ID code, etc.) is entered in the `WN3000.ini` file.
- The network size (the number of BACnet Routers) is specified.
- The BACnet Routers and Field Controllers are named.

**Note:** Do not manually make entries to the `WN3000.ini` when installing a site on the PC. All necessary changes will be made to the `WN3000.ini` file by the **Configuration** utility.

### HOW A NEW SITE IS INSTALLED ON THE PC

Installing a new site on the PC involves the following procedures:

- Naming the new site in the **Configuration** program.
- Entering the size of the site (number of BACnet Routers) in the **Configuration** program.
- Naming the BACnet Routers and Field Controllers in the **Configuration** program.
- If the site is not a remote site, it can be configured as the default site (see *System Configuration* on page 30).
- Restarting **Microsoft Windows** and the CXpro<sup>HD</sup> for the changes to take effect.

### SITE BACKUP

Making a site backup means making a copy of all site-relevant data on the PC onto removable media such as network, USB flash drive, external Hard Disk, or tape. A site can then be recreated on another PC running CXpro<sup>HD</sup> from this site backup.

## MAKING A SITE BACKUP

To backup a site, right-click on the site in the Site Tree, and select Backup Site from the context menu:

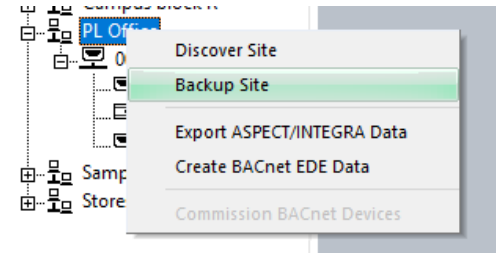

You will be prompted for a location to save the backup file:

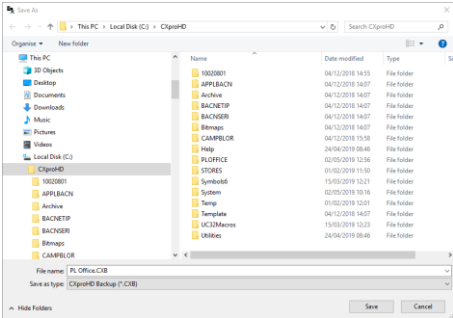

Select any suitable device or folder and click Save.

## RESTORING A SITE FROM A BACKUP FILE

To restore a site from a backup, right-click on the **Sites** node in the **Site Tree**, and select **Restore Site** from the context menu:

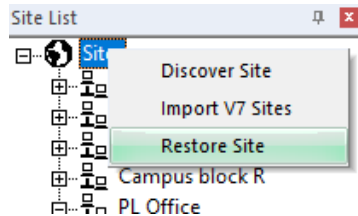

Choose the required backup file and click **Open**:

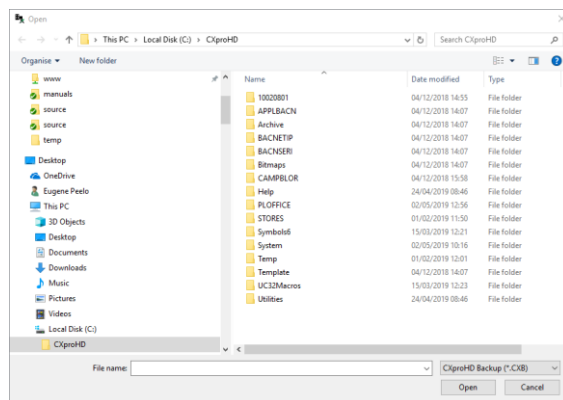

If no site with the same name exists, then the restored site is added to the system as a new site.

If a site by the same name exists, the user will be asked to choose either to overwrite the existing site or to create a new site.

- If you choose to overwrite the site that has the same name, the existing site will be completely overwritten. You will be asked to confirm that you want to proceed.
- If you choose to create a new site, you will be asked to enter a new name, and a new site will be added to the site tree. The chosen name must be unique.

You can cancel the restore process at any time.

## SITE DISCOVERY

Strategy block data can be uploaded from **ABB Cylon**<sup>®</sup> controllers and re-assembled into an easy-to-view layout. This is useful when you have a Site where you do not have existing strategy drawings or other information.

The purpose of the discovery process is to determine all of the Subnets (i.e. a Fieldbus connected to a BACnet Router) on a Site.

**Note:** All Subnets are searched so that the integrity of the data passed between Subnets (e.g. wide globals) remains intact. This happens even if you are looking for information on a single Subnet. This process can be lengthy, so please ensure that sufficient time is allocated for it. However, you do not have to upload all Subnets at one time. If you specify a **Subnet Range** for a specific upload, you can retrieve the other Subnets at a later point in time.

The upload process is started from the **Site Tree**, either from the **Sites** Icon (if the Site is not already in the tree) or from the relevant Site node.

### IF THE SITE IS NOT YET CONFIGURED IN THE SITE TREE

Click on the **Sites** icon in the **Site Tree**, and select **Discover Site**

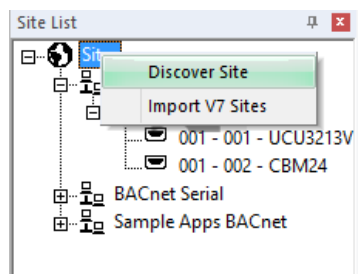

This opens the **Discovery Site Details** dialog with all fields editable.

Enter the **Site Name** and **Site Directory** directory.

If you do not want to retrieve all Fieldbusses on the Site, specify a **Subnet Range**.

Sites can be uploaded either through TCP/IP or through a serial connection. For TCP/IP connections, include the **IP Address** and verify the port. Port **4950** is the default.

When configured, click **Discover**.

## IF THE SITE IS ALREADY CONFIGURED IN THE SITE TREE

If the Site is represented in the Site Tree – i.e. if it has been configured locally configured using the Configuration Utility (CCConfig), click on its node in the Site Tree and select Upload Site:

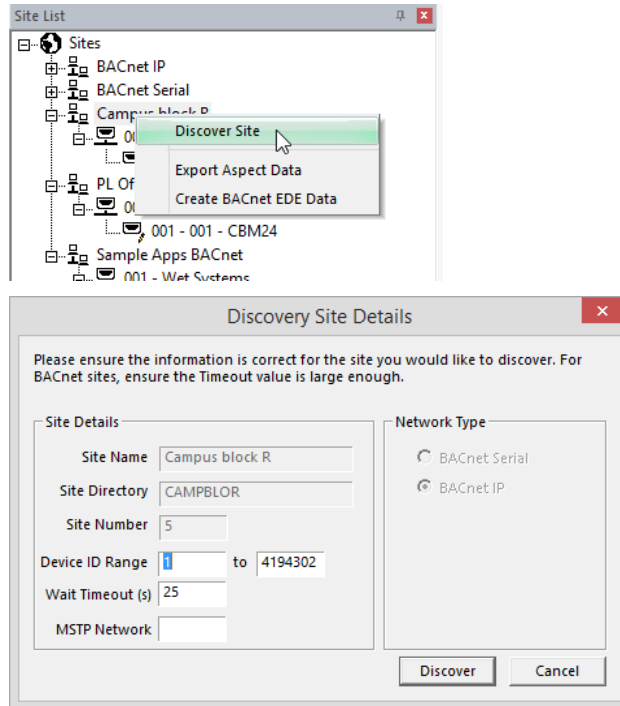

The Discovery Site Details dialog will be displayed as before, but in this case, the Site details are not editable. When configured, click Discover.

After the discovery process is started, the Site Discovery Progress dialog appears showing its progress:

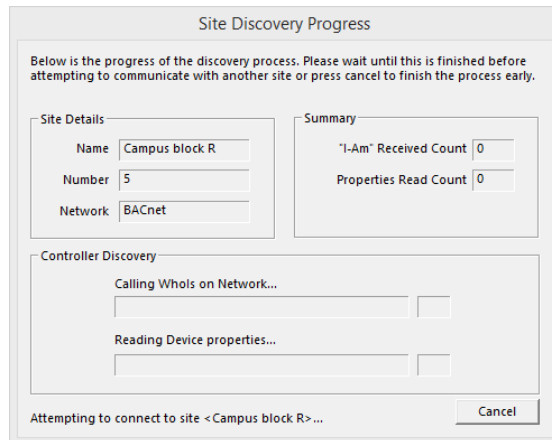

If you click Cancel to stop the process, any uploaded information is discarded and not applied to the Site in CXpro<sup>HD</sup>.



When the discovery has concluded, the discovered Fieldbusses /BACnet Routers are displayed in the BACnet Explorer dialog:

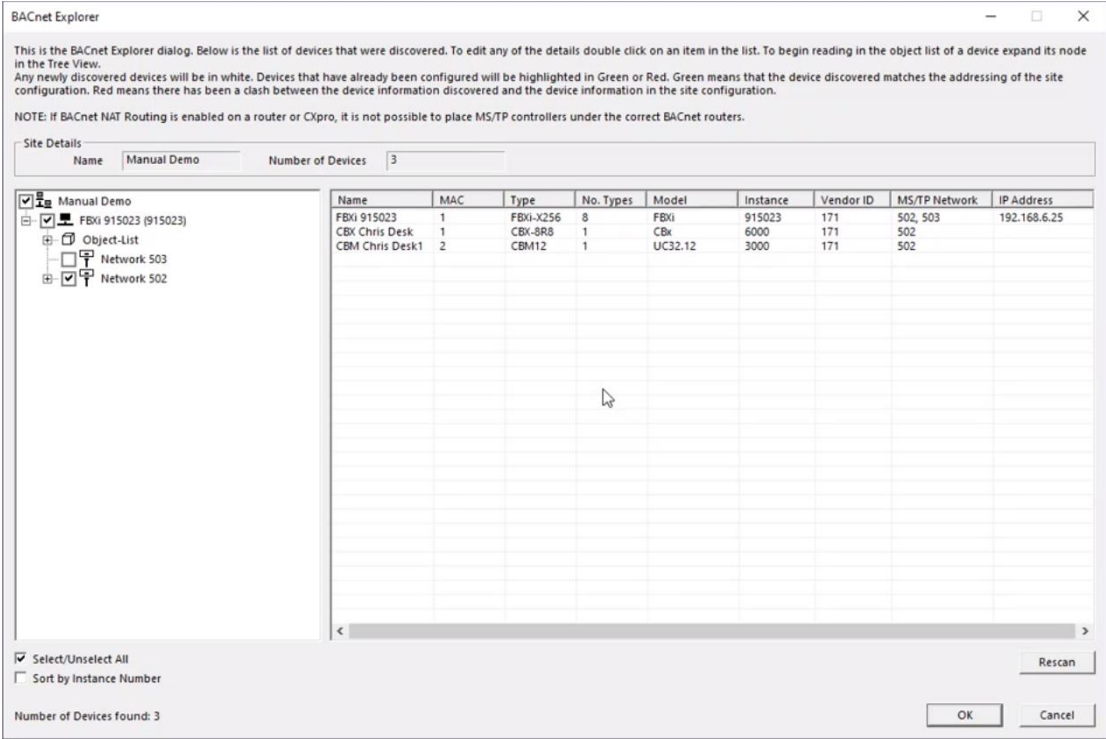

and any discovered sites are added to the Site List

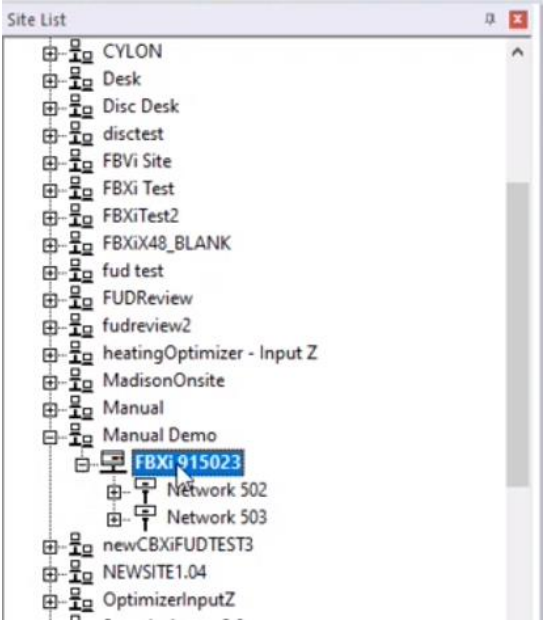

## FULL UPLOAD AND DOWNLOAD

### DOWNLOAD

FBXi, CBXi and FBVi controllers with Firmware v9.1.0 and later have additional capabilities over previous **ABB Cylon** controllers and are referred to as “Smart Routers”. One of these features is the ability to store the strategies and configuration for the controller, and also support full upload and download of data for MSTP fieldbus controllers.

When changes are made to the strategy of a selected Controller, and then the **Connect** button is clicked,

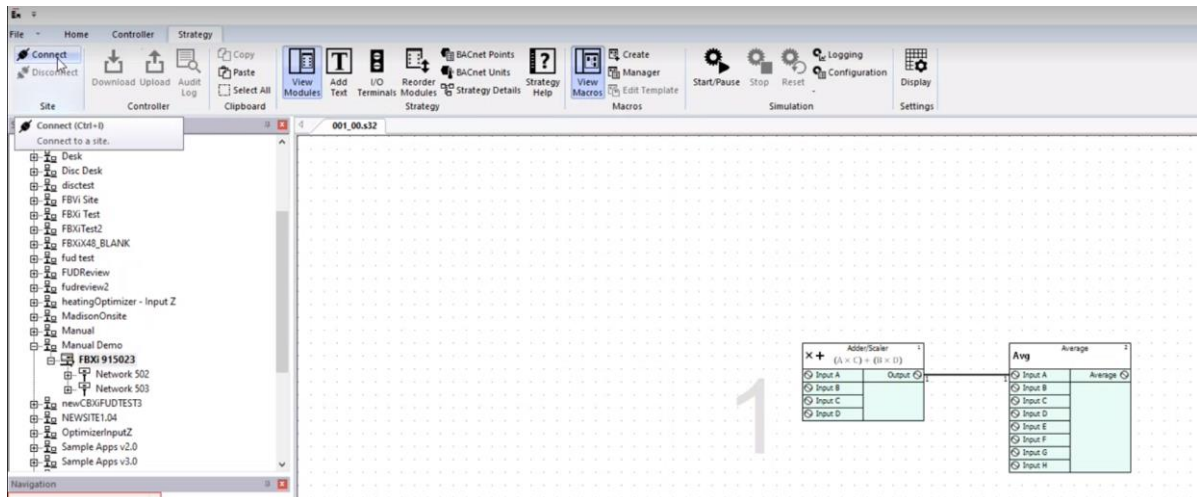

CXpro<sup>HD</sup> checks whether or not the controller is connected to a Smart Router – i.e. a router that supports full upload and download of controller data.

If it is, then downloading will proceed as follows:

1. Click the **Download** button. it may be accessed from the **Strategy** tab or the **Controller** tab.



2. The **Audit Log** dialog will open. Enter a **User** name and a **Change** message, for example a description of and justification for the changes made to the strategy. The timestamp is added automatically.

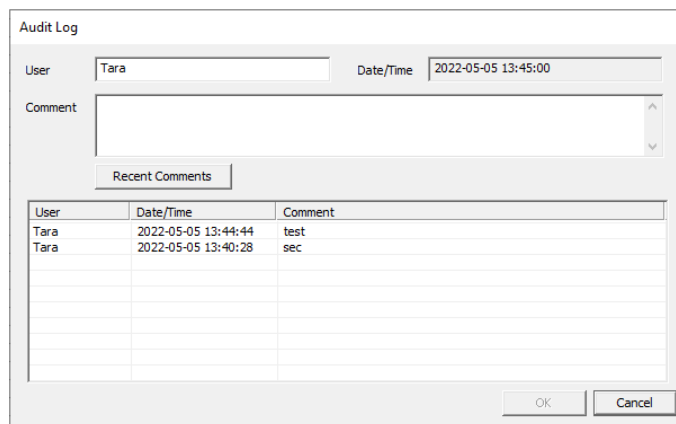

**Note:** By clicking the **Recent Messages** button you can reuse one of the 10 most recent messages to speed up entry of the **Change** message.

3. Click the **OK** button on the **Audit Log** dialog to continue with the download process.

- Next, the data currently held in the router is uploaded,

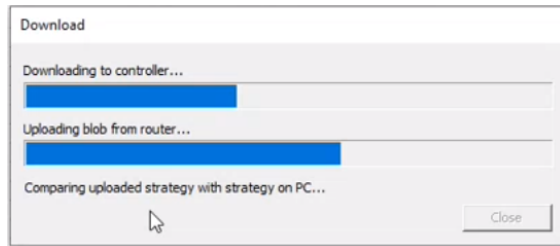

- Then CXpro<sup>HD</sup> compares the upload with the strategy on the PC to identify 'breaking' changes (changes that would significantly impact the operation of the controller). For example new modules added to the strategy might be considered 'breaking' changes, whereas changes to internal constants in a module might be considered 'non breaking'.
  - If 'breaking' changes are identified, CXpro<sup>HD</sup> will display a message informing the user that a Full download is required, which will cause the outputs of the controller to cycle.

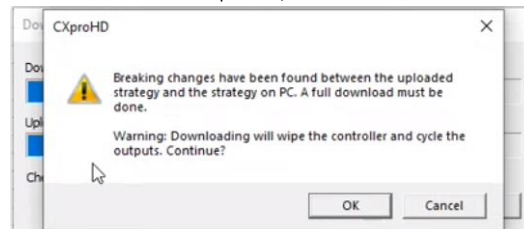

- If no 'breaking' changes are identified then a partial download will be carried out, where only the changes are sent to the controller and the outputs are not cycled.

**Note:** During the conversion from CXpro<sup>HD</sup> v1.5 to CXpro<sup>HD</sup> v1.6 and the upgrading CBXi/FBXi/FBVi to v9.1.0, if there is no upload file present then breaking changes cannot be identified – meaning that the alert will not appear. Once there is an uploaded file to compare with the PC version of the strategy, then the breaking changes alert will appear if appropriate.

## UPLOAD

FBXi, CBXi and FBVi controllers with Firmware v9.1.0 and later have additional capabilities over previous **ABB Cylon** controllers and are referred to as “Smart Routers”. Features include the ability to store the strategies and configuration for the controller, and also support for full upload and download of data for MS/TP fieldbus controllers.

**Note:** An FBVi controller will allow upload of its own strategy only. A CBXi or FBXi controller will allow upload of its own strategy or upload of strategies from an MSTP network controlled by it.

**For example:** If a site contains a mix of CBXi controllers some with v9.0.0 and a some with v9.1.0, only those MSTP devices connected to the v9.1.0 CBXi routers will have the option to upload strategies. Any MSTP controllers under any of the v9.0.0 CBXi routers will not have that option. Once those CBXi routers are updated to v9.1.0, the MSTP devices connected to them will have the option to upload strategies.

Sample Update Scenario:

1. Update CBXi controllers on a Site to v9.1.0 firmware
2. Run Discovery on the Site in CXpro<sup>HD</sup> v1.6
3. CBXi controllers that were formerly at v9.0.0 and the MSTP devices under those controllers are now recognized by CXpro<sup>HD</sup> as being capable of upload/download. However, in order to make the upload facility available strategies must first be downloaded as follows:
  - a. When converting a site from CXpro<sup>HD</sup> v1.5 to CXpro<sup>HD</sup> v1.6 make sure that all setpoint values have been saved to the PC copy of the strategy. To do this, right-click on the controller and select Strategy Operations > Upload Setpoints.
  - b. After upgrading the smart router, download the strategy back to the controller. The facility to upload the strategy back to the PC is now available.

If a fieldbus is controlled by a Smart Router, then the strategy and configuration of that controller and also all MSTP fieldbus controller data can be uploaded as follows:

1. Right-click on the controller and select Upload Strategy or the Upload button, accessed from the Strategy tab or the Controller tab.

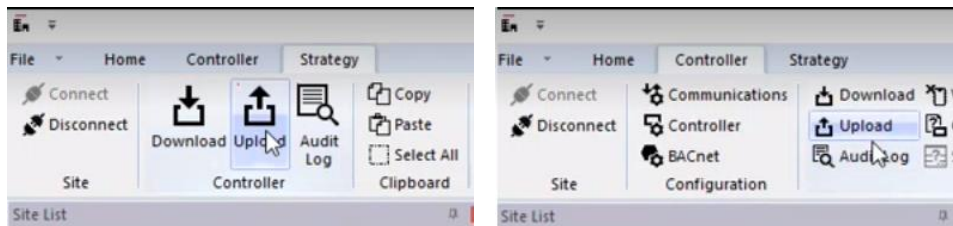

2. Data is uploaded from the Smart Router.

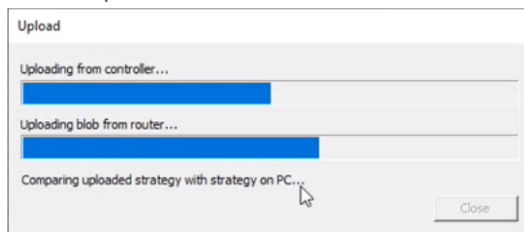

3. CXpro<sup>HD</sup> compares the upload with the strategy on the PC, and if there are differences, they are displayed in the dialog below:

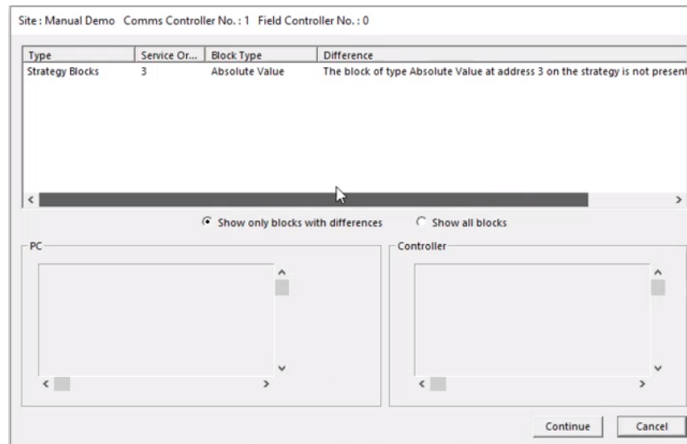

- If the listed differences can be overwritten on the PC, click the **Continue** button, and the strategy in the PC will be replaced with the uploaded version.
- If the differences are such that you don't want the strategy on the PC overwritten by what is on the controller, click **Cancel** and the strategy in the PC will be maintained, and can later be downloaded to the controller.

- Dashboard
- BACnet
- IP Network
- RS 485 Ports
- Smart Router
- Devices
- Platform
- Captures
- Diagnostics

refresh

Name	Instance	Network	Address	Status
001 - FBXi-X256	123456	500	192.168.1.2	✓
CBX001	749283	502	ID:125	↓

» | Sites

## SMART ROUTER CONTROLLER REPLACEMENT (WEB PAGE)

Smart Routers (such as FBXi-X256, FBXi-X48 or CBXi v9.1.0 or later) can facilitate controller replacement through the Router Web page, allowing an ABB MSTP controller to be easily replaced and restored of without the use of CXpro<sup>HD</sup>.

### Devices List

In the Web UI of a Smart Router, an overview of the MSTP controllers connected to it is displayed by selecting Smart Router > Devices from the left-hand menu:

Device name: FBXi Series 123456 192.168.1.2

refresh

Name	Instance	Network	Address	Status
001 - FBXi-X256	123456	500	192.168.1.2	✓
CBX001	749282	502	ID:125	✓

For Smart Routers that have no strategies downloaded to them, no controllers will be listed.

If the Smart Router itself contains a strategy that has been downloaded, the router will be the first controller on the list.

If any of the MSTP controllers that are directly connected to the smart router have downloaded their strategies, they will appear on the list.

Overview information such as Device Instance, Network, Address and Status information for each controller is displayed in this view.

If the Smart Router can communicate with a controller, a green checkmark is displayed in the Status column for that controller.

If the Smart Router cannot communicate with a controllers, a red X symbol is displayed in the Status column for that controller.

Device name: FBXi Series 123456 192.168.1.2

refresh

Name	Instance	Network	Address	Status
001 - FBXi-X256	123456	500	192.168.1.2	✓
CBX001	749282	502	ID:125	✗

If one of the controllers is replaced with a new one that is configured with the same MSTP address, a blue download icon is displayed in the Status column:

Device name: FBXi Series 123456 192.168.1.2

refresh

Name	Instance	Network	Address	Status
001 - FBXi-X256	123456	500	192.168.1.2	✓
CBX001	749283	502	ID:125	↓

## Accessing a controller manually

To view detailed information about a specific controller (including the current and previously discovered state of the controller, as well as relevant timestamps), and to backup/restore it manually, click on that controller in the **Smart Router > Devices** list.

The screenshot shows the ABB CXproHD interface. At the top left is the ABB logo. The top right shows the device name: 192.168.1.2. Below this is a 'Configured Information' section with a 'refresh' button. The information includes: Instance: 749282, Name: CBX001, User ID: grosu, CXPro Created: 2022-05-07T12:18:40+0300, and Backup From Device: 2022-05-07 05:18:56. Below this is a table comparing 'Currently Discovered' and 'Previously Discovered' data. The 'Currently Discovered' data includes Instance: 749282, Name: grosu, Serial: CX16749282C, Network: 502, MAC: ID:125, Model: CBx, Version: CBx 9.0.0-A8 21-10-22 Boot Ver:03.03.04, Strat. Size: 2610, and Date: 2022-05-07 05:48:27. The 'Previously Discovered' data includes Instance: 749282, Name: grosu, Serial: CX16749282C, Network: 502, MAC: ID:125, Model: CBx, Version: CBx 9.0.0-A8 21-10-22 Boot Ver:03.03.04, Strat. Size: 0, and Date: 2022-05-07 05:19:01. Below the table is a 'Status: Normal' indicator. At the bottom are three buttons: 'Restore to Device', 'Backup from Device', and 'Delete from Router', each with a corresponding description.

Currently Discovered	Previously Discovered
Instance: 749282	749282
Name: grosu	grosu
Serial: CX16749282C	CX16749282C
Network: 502	502
MAC: ID:125	ID:125
Model: CBx	CBx
Version: CBx 9.0.0-A8 21-10-22 Boot Ver:03.03.04	CBx 9.0.0-A8 21-10-22 Boot Ver:03.03.04
Strat. Size: 2610	0
Date: 2022-05-07 05:48:27	2022-05-07 05:19:01

**Status: Normal**

Restore to Device	Restore the targeted controller to last saved configuration.
Backup from Device	Backup strategy and BACnet settings from device.
Delete from Router	Remove this CXPro configuration from SmartRouter.

There are 3 buttons at the bottom of this page:

### 1) Restore to Device

Clicking this button restores the state of the previously configured controller at the same MSTP address. This would be used if a new controller was put in the place of an existing one, and the new controller was assigned the MSTP address of the one it is replacing. Select the old controller from the **Smart Router > Devices** list and click the **Restore to Device** button. The stored strategy and device data will be restored to the new controller and the green checkmark will appear in the **Smart Router > Devices** list.

### 2) Backup From Device

The **Backup from Device** option allows the manual transfer of the device strategy and BACnet data (including setpoints, k-factor etc.) to the Smart Router.

**Note:** This step is required in the case of a controller that has been commissioned while CXpro<sup>HD</sup> is not available on site. This could happen if, for example:

- A VAV was balanced using **Aero<sup>BT</sup>** or
- A BACnet program such as **NBPro** is used to change values in a controller strategy

If the controller is replaced at a later stage, the **Backup from Device** step will ensure that the commissioned data (such as k-factor) will be available for the replacement controller.

If CXpro<sup>HD</sup> is subsequently connected to the site, it can be updated by running the **Batch Upload** command, and the saved setpoints will be uploaded to the strategy on the PC for backup.

### 3) Delete from Router

The **Delete from Router** option will delete the controller information from the **Smart Router** so that it will no longer appear in the **Smart Router > Devices** list. The functionality of the controller will not be affected, and it will continue to run the existing strategy file.

**Note:** This will delete the backup and will not be recoverable. Please ensure that the strategy has been saved in CXpro<sup>HD</sup>.

# BATCH UPLOAD AND DOWNLOAD

## BATCH DOWNLOAD

It is possible to download multiple strategies from the PC to multiple controllers in a single action. To do this,

1. Right-click on a site in the Site Tree, and select Batch Download:

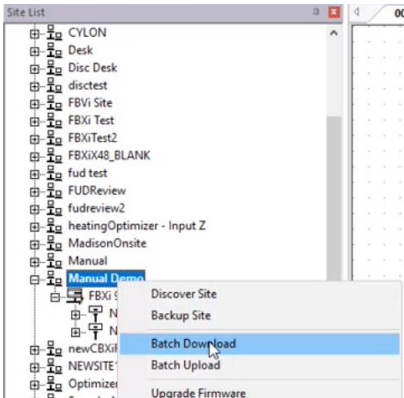

2. Select the controllers for which strategies will be downloaded from the list of all of the controllers on the selected site

**Note:** If a controller does not have an associated strategy it will not be displayed in this list

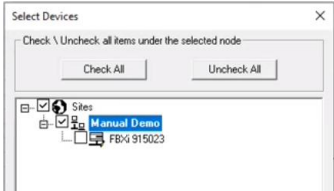

3. When the required controllers are selected, click the Continue... button. The Select Batch Download Options dialog will be displayed:

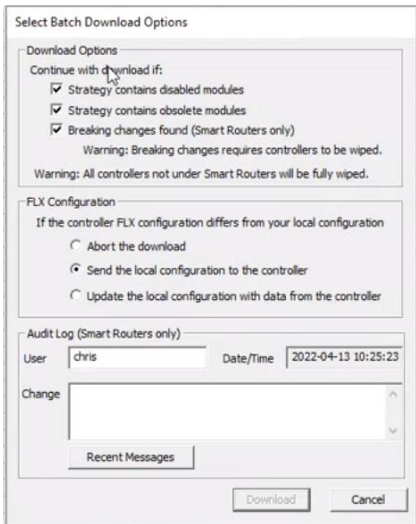

This allows you to define the conditions under which download would stop:

- If a strategy contains disabled modules (e.g. hardware points in the strategy for which there is no corresponding physical FLX configured, or Modbus modules for which no Modbus device is



- selected), then the download will stop for that controller and download moves to the next controller.
- If the strategy contains obsolete modules, then the download will stop for that controller and download moves to the next controller.
- If “Breaking” changes are found, then the download will stop for that controller and download moves to the next controller.

And to specify what should happen if extended I/O on FLX units is configured differently from what is expected:

- Abort the download
- Send the I/O configuration from the PC to the controller
- Leave the I/O configuration on the controller, and update the PC configuration to match

If there is at least one **Smart Router** on the site, then there is also an opportunity to add a comment to the **Audit Log**.

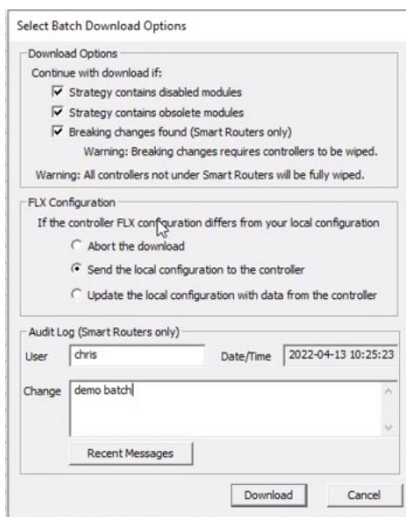

4. Click **Download**. Download will proceed for the selected devices, showing conflicts and if any of the ‘Continue with download if’ in the previous dialog were unchecked, an error message will be displayed if the condition is encountered.

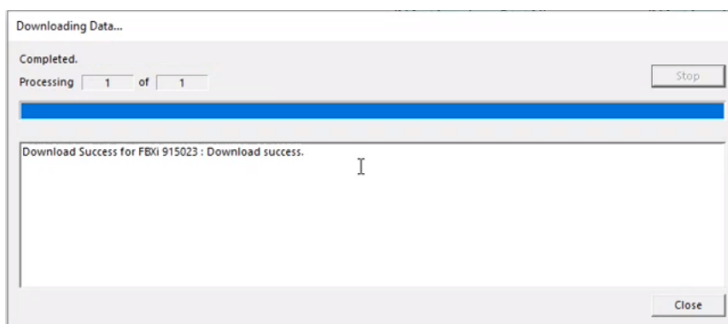

## BATCH UPLOAD

It is possible to upload multiple strategies from multiple controllers on a site to the PC in a single action:

**Note:** If a site is restored from a backup that was made when a specific Router's firmware was earlier than v9.1.0 and then a Batch Upload is carried out, the router will not be recognized as a Smart Router. In this case you should either open the strategy and connect to the controller, or else run a Site Discovery. CXpro<sup>HD</sup> will then register the Router as a Smart Router and Upload/Download will proceed as normal.

- 1. Right-click on a site in the Site Tree, and select Batch Upload

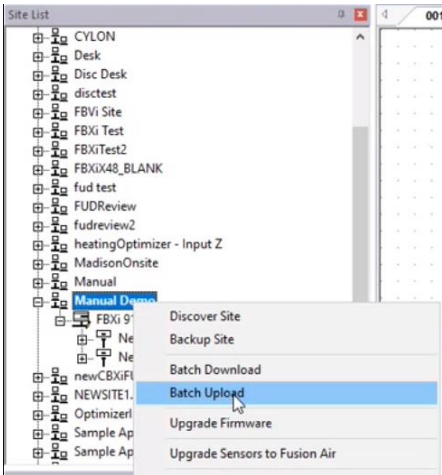

Upload is a feature of Smart Routers only, so when Batch Upload is selected for a site, CXpro<sup>HD</sup> checks each of the routers on the selected site and displays devices that are connected to a Smart Router in the Select Devices dialog:

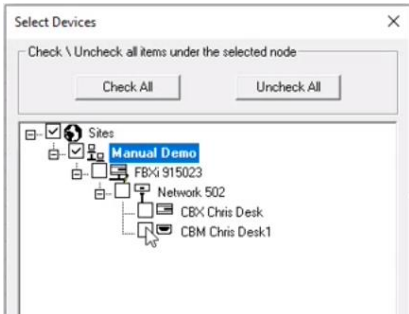

This will show all devices under a smart router, whether they have a strategy or not, because they may still have a strategy on the smart router.

- 2. Select the required devices:

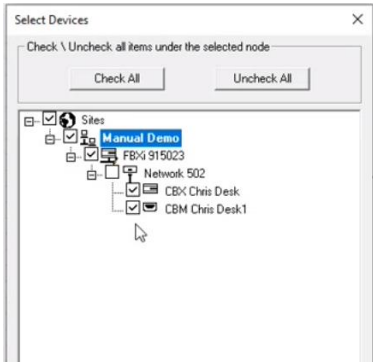

3. Click **Continue**. CXpro<sup>HD</sup> uploads data from the router.

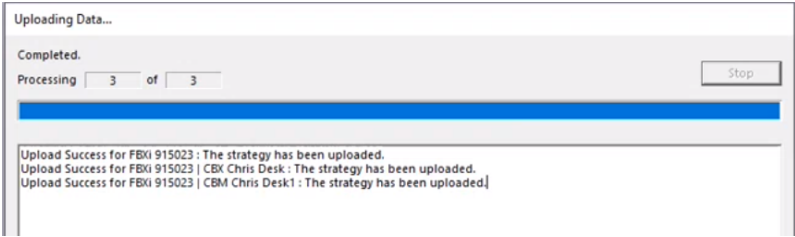

When complete, the selected controllers for which there were strategies on the Smart Router will have Associated strategies even if they didn't have any before.

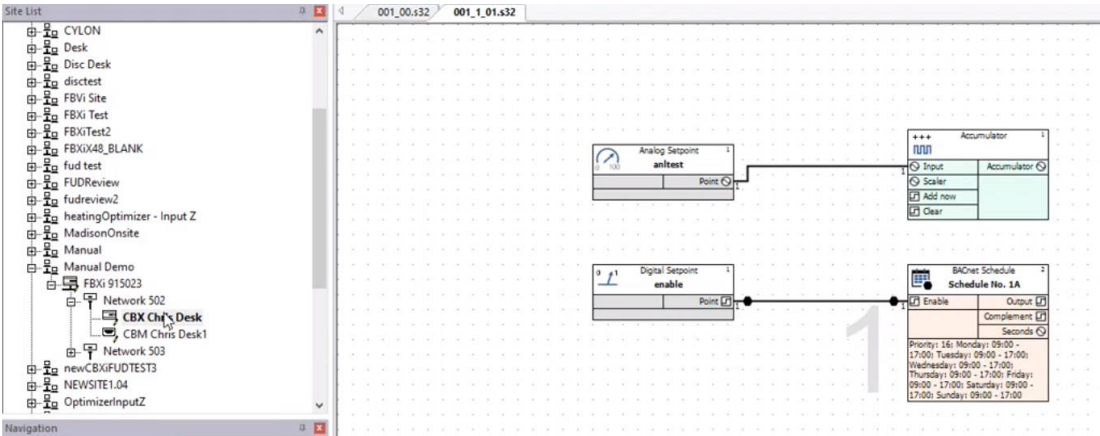

Setpoint values that are stored on the controller will also be saved back to the PC.

### VIEWING THE AUDIT LOG

Whenever data is downloaded to a controller that is under a Smart Router, the user has an opportunity to record a comment about the change, allowing them for example to explain why the change was made.

The last 10 changes that were sent to the Smart Router can be viewed by clicking the Audit Log button which is under the **Strategy** tab or the **Controller** tab:

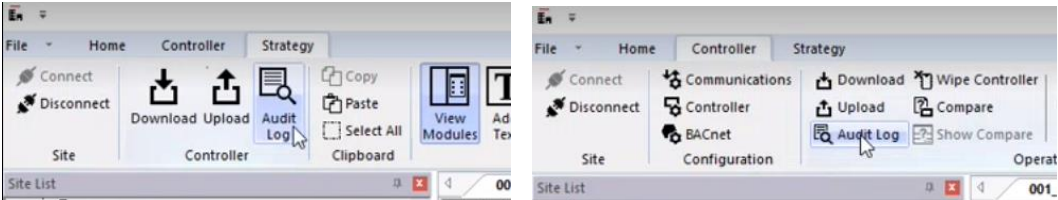

## FIRMWARE UPGRADE

CXpro<sup>HD</sup> can load firmware from a local file on the PC to one or more controllers. To do this,

- 1. Right-click on a site in the **Site Tree**, and select **Upgrade Firmware**

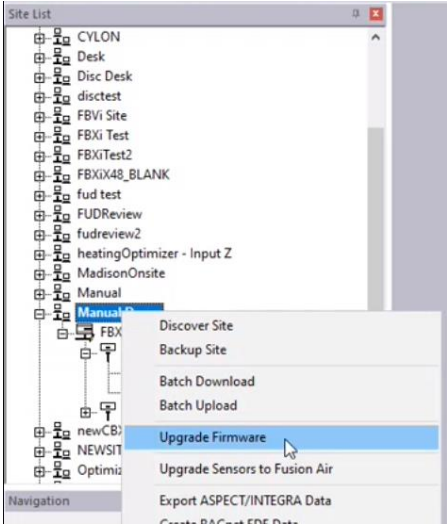

- 2. select the controllers for which you want to upgrade the firmware.

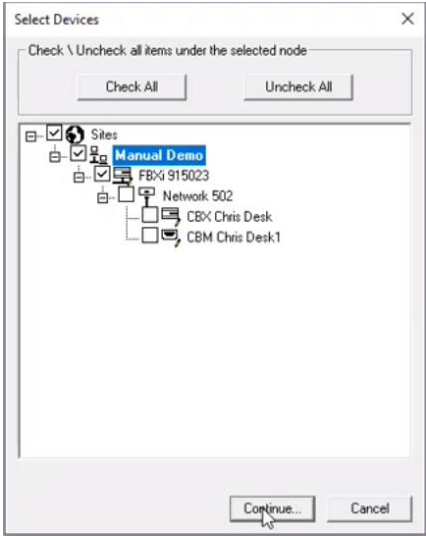

- 3. Click **Continue**

- Select the **.flx** files (for FLXeon controllers) or **.bin** files (for all other controllers) that represent the required firmware.

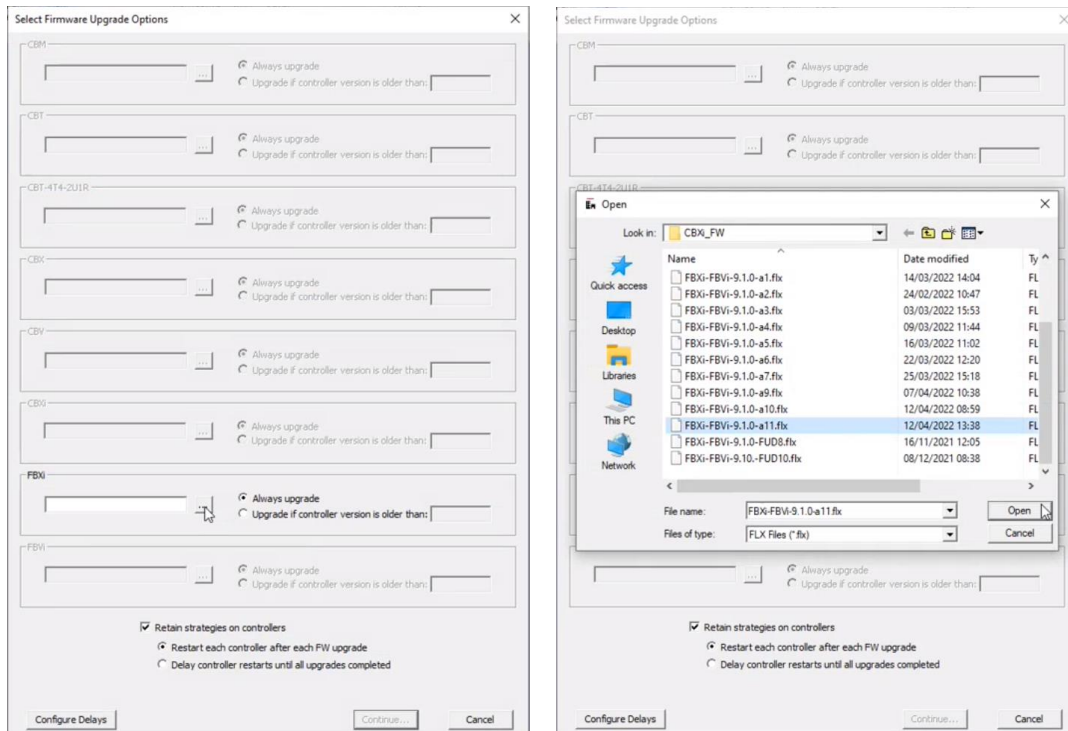

- Select whether all controllers will be upgraded (**Always Upgrade**) or just specific versions (**Upgrade if controller version older than:**)
  - As firmware upgrade requires the controller to be wiped, specify if the strategy should be backed up before the upgrade and restored afterwards by checking the **Retain Strategy on controller** box. If **Retain Strategy on controller** is selected, it will be possible to select:
    - whether each controller will restart as soon as its firmware is upgraded (**Restart each controller after each FW upgrade**), or
    - if all controllers will be upgraded before any of them restart (**Delay controller restarts until all upgrades completed**). This second option will significantly reduce the amount of network traffic, saving time for the overall process.
  - When the dialog is complete, click **Continue** to download the Firmware.
- To close the dialog without adding this Firmware Upgrade to the batch, click **Cancel**.

**Note:** When the firmware upgrade is run (i.e. when **Actions > Run/Complete Batch** is next selected) the Instruction window will list any firmware upgrades as they happen. If **Restart each controller after each FW upgrade** was selected, then the setup block sent with each restored strategy will restart the Controller. However, if **Delay controller restarts until all upgrades completed** is selected, then the setup in each strategy will be set to 0 blocks and an extra **Setup** command will be sent at the end of the Firmware Upgrade process as shown below:

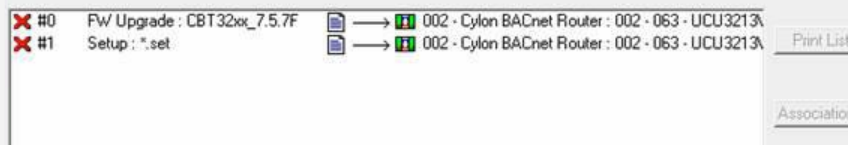

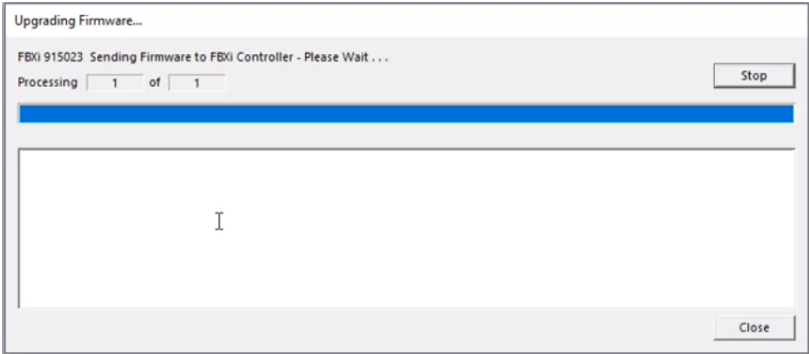

Any errors or warnings will be displayed in the bottom part of this dialogue

**Note:** This upgrade can take a long time if there are large files to be downloaded.

When the upgrade is complete, the Router reboots, and a timeout is displayed for this:

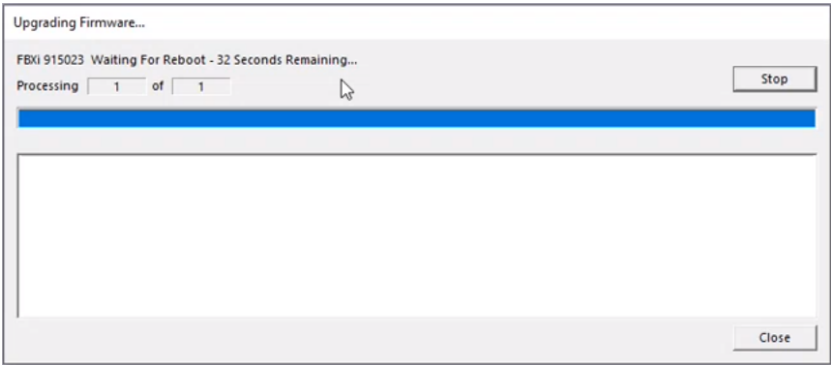

**Note:** This can take some time, for example the FBXi device takes 65 seconds to reboot.

## UPGRADE SENSORS TO FUSION AIR

Specific products (e.g. CBV-2U4-3T or FBVi-2U4-4T) which contain factory ‘canned’ strategies supporting CBT-STAT sensors, can be automatically upgraded to support FusionAir sensors instead of CBT-STAT if required.

1. Right-click on a site in the **Site Tree**, and select **Upgrade Firmware**

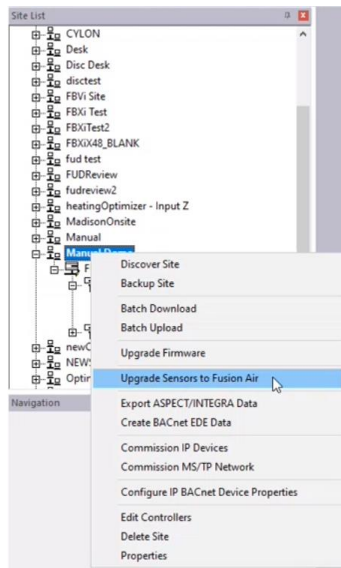

2. Select the devices to be upgraded:

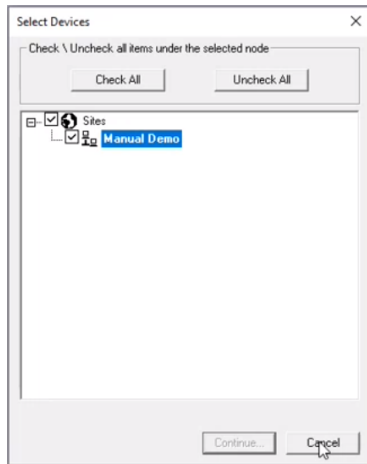

**Note:** If there are no relevant devices configured with factory strategies on the site, then nothing will be displayed in this dialog.

3. Click **Continue**. Qualifying Strategies in the selected controllers will be updated to support FusionAir sensors.

# ASPECT® / INTEGRA™ EXPORT

This feature saves data for a Controller, Fieldbus (Subnet), or Site into a JSON-formatted text file for import into ASPECT® or INTEGRA™, allowing applications to be automatically configured in ASPECT®-Studio or INTEGRA™ IT-8000.

## STARTING THE EXPORT

To export a Field Controller, BACnet Router, or Site, right-click on its node in the Site Tree and choose Export ASPECT/INTEGRA Data.

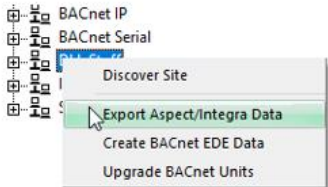

If a Field Controller is selected, that controller’s information is exported to the ASPECT® / INTEGRA™ .json file, along with the parent network and parent site information as required to correctly import into ASPECT® or INTEGRA™.

If a Fieldbus is selected, information for all controllers in that Fieldbus is exported along with the parent site information as required to correctly import into Aspect.

If a Site is selected, information for all Controllers on all Fieldbusses within that site will be exported.

The points that will be exported will be those that are specified in the Export column of the BACnet Points dialog. The BACnet Points dialog is opened by clicking on BACnet Points in the Strategy tab of the ribbon – see *How to expose Points on a BACnet system* on page 127.

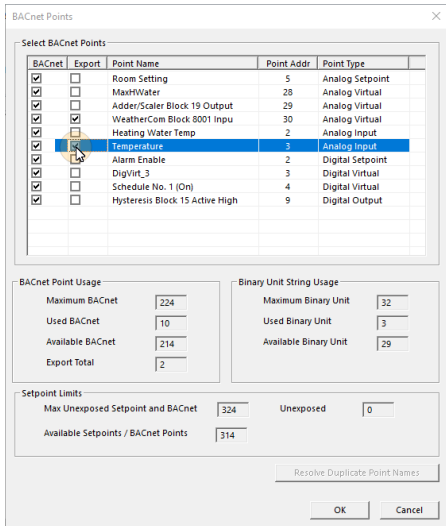



After exporting, set a name for the export file that you want. By default, it is set to the name of the Site. The filename extension must remain as `.json` for easy import into ASPECT® or INTEGRA™.

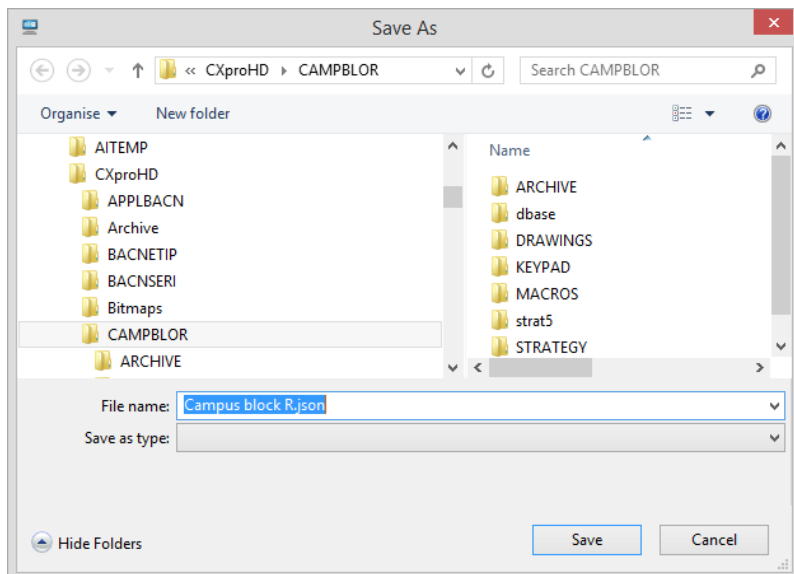

After setting the filename, click **Save**.

The process will begin to export information. The **Creating Aspect Data...** dialog will be displayed to show the progress of the export:

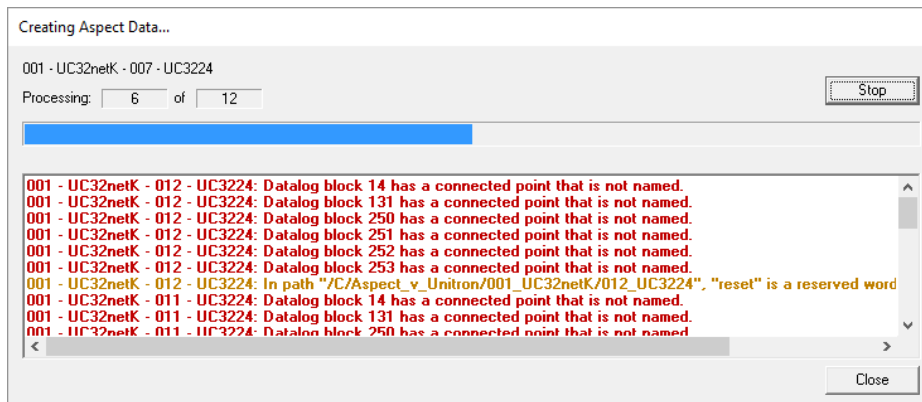

For any errors or warnings encountered, you will see the network (Fieldbus) name, the name of the controller, and the action that should be taken. Correct these errors in the appropriate strategy or configuration and then start the Export process again.

You may stop the export process at any time and review the errors and warnings.

You may copy the errors and warnings from the dialog into a document or email.

When finished, click **Close** to complete the process.

## IMPORT INTO ASPECT®-STUDIO AND INTEGRA™-PROPACK

Refer to *MAN0129 ASPECT®-Studio* for details about importing the `.json` data into ASPECT®.

Refer to *MAN0140 INTEGRA™ ProPack* for details about importing the `.json` data into INTEGRA™.

### Launching CXpro<sup>HD</sup> from INTEGRA™-ProPack

When an export file from CXpro<sup>HD</sup> is imported into an IT-8000, it is then possible to launch CXpro<sup>HD</sup> from the INTEGRA™ UI – targeting a specific controller for engineering or debugging.

In order to do this, ensure you have CXpro<sup>HD</sup> installed on your computer, and INTEGRA<sup>TM</sup> version 4.7 or greater is installed on the IT-8000 or supervisor. Also, ensure that the CylonService is installed.

You must also have a copy of the CXpro<sup>HD</sup> project and strategies in CXpro<sup>HD</sup>.

**Note:** The CylonService uses the site name and device instance numbers to locate the strategy in CXpro<sup>HD</sup>, so you must ensure that the site name in the INTEGRA<sup>TM</sup> station matches the site name in CXpro<sup>HD</sup>. To verify or edit the site name in the INTEGRA<sup>TM</sup> station, open the property sheet for CylonBacnetNetwork :

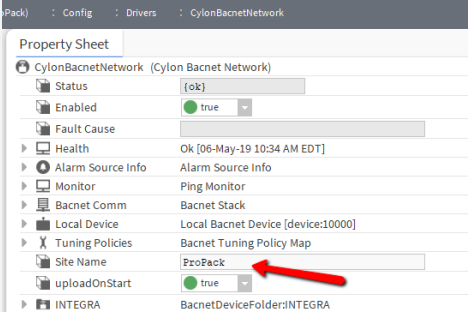

To launch CXpro<sup>HD</sup>, right-click on the ABB Cylon<sup>®</sup> controller and choose Launch CXpro<sup>HD</sup>:

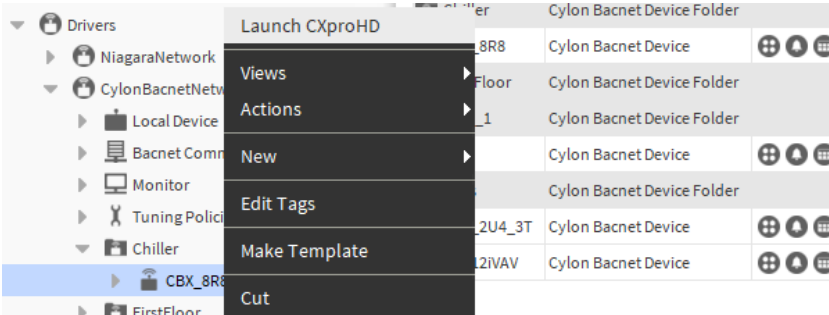

CXpro<sup>HD</sup> will open at the project and the last-saved strategy for the selected controller, allowing you to debug, make code changes, and download it to the controller.

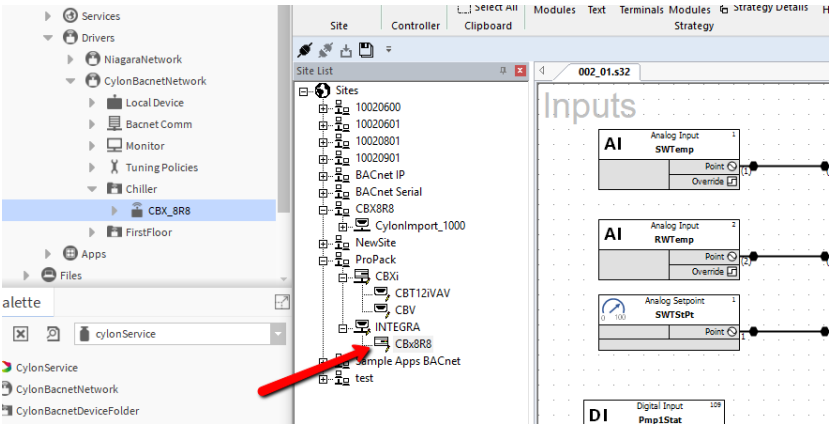

# Aero<sup>CT</sup> CONFIGURATION

Aero<sup>CT</sup> is a mobile application that allows users to commission Controllers, edit Setpoints, and view graphs for tuning Site performance.

In order to use the mobile app, the Site must be configured to expose **setpoints** and **points to graph**, from CXpro<sup>HD</sup>.

**Note:** This feature is only available for controllers that have External Flash.

**Note:** Aero<sup>CT</sup> Configuration is only supported on controllers with Firmware Version 9.1.0 or greater.

From the Ribbon Bar under the Strategy Tab, select Configure AeroCT.

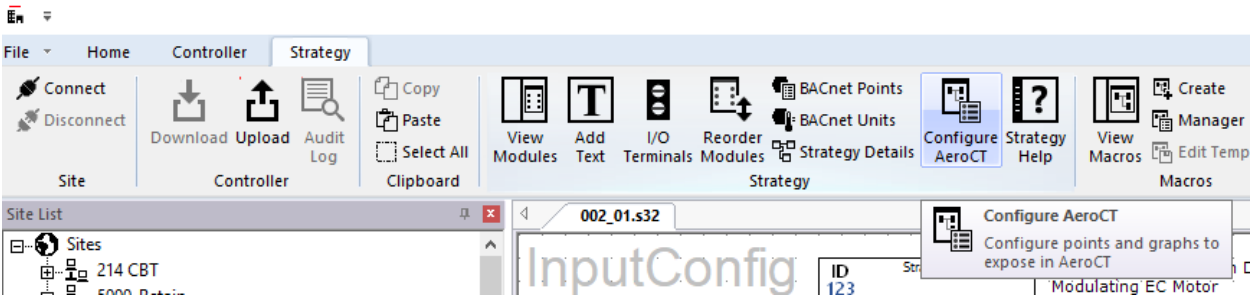

This opens the AeroCT configuration dialog:

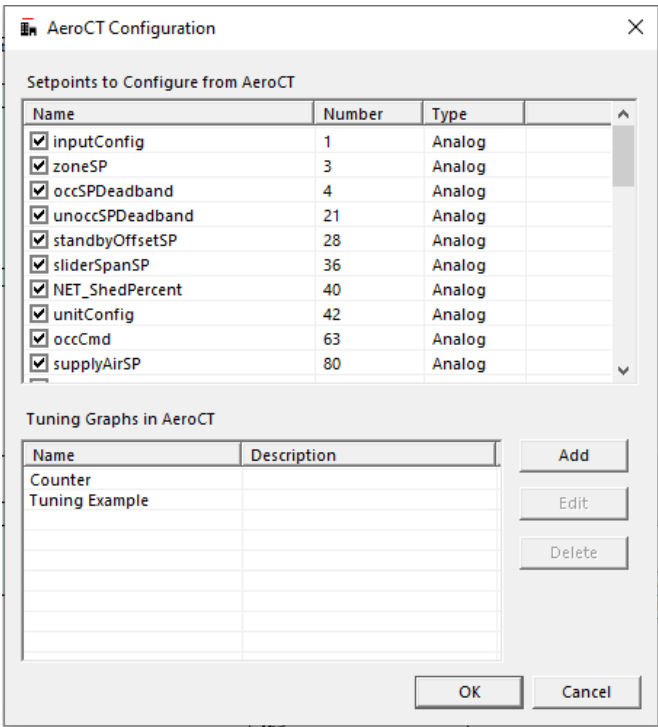

## SETPOINTS TO CONFIGURE

The list at the top of the AeroCT configuration dialog shows all of the BACnet exposed Setpoints in the strategy.

By default, all BACnet exposed Setpoints in the strategy are set to be configurable in the AeroCT application. However, you can select a subset of Setpoints to be configurable in the Aero<sup>CT</sup> application by unchecking the box beside any setpoint that should not be visible in Aero<sup>CT</sup>.

This list supports multiple selection to easily check/uncheck groups of Setpoints.

## TUNING GRAPHS

The second list in the AeroCT configuration dialog shows Tuning Graphs that can be viewed in the Aero<sup>CT</sup> application. The Description field will show if there's any issues detected with the Tuning Graph.

To define a Tuning Graph, click the Add button. This will open the Add AeroCT Tuning Graph dialog.

Name	Number	Type
<input type="checkbox"/> StrategyVersion	2	Analog Virtual
<input type="checkbox"/> CBTStat_Temp	43	Analog Virtual
<input type="checkbox"/> CBTStat_Humidity	44	Analog Virtual
<input type="checkbox"/> CBTStat_HeatingSP	45	Analog Virtual
<input type="checkbox"/> CBTStat_CoolingSP	46	Analog Virtual
<input type="checkbox"/> activeCoolSP	49	Analog Virtual
<input type="checkbox"/> activeHeatSP	50	Analog Virtual
<input type="checkbox"/> zoneTemp	61	Analog Virtual
<input type="checkbox"/> fanRuntime	68	Analog Virtual

Name	Number	Type	Description
<input type="checkbox"/> inputConfig	1	Analog	
<input type="checkbox"/> zoneSP	3	Analog	
<input type="checkbox"/> occSPDeadband	4	Analog	
<input type="checkbox"/> unoccSPDeadband	21	Analog	
<input type="checkbox"/> standbyOffsetSP	28	Analog	
<input type="checkbox"/> sliderSpanSP	36	Analog	
<input type="checkbox"/> NET_ShedPercent	40	Analog	
<input type="checkbox"/> unitConfig	42	Analog	

The Add AeroCT Tuning Graph dialog lists all BACnet exposed Virtual and Hardware points in the strategy. Up to 10 Points can be selected to Graph in the Aero<sup>CT</sup> application

The second list in the Add AeroCT Tuning Graph dialog shows the BACnet exposed Setpoints in the strategy. Select any Setpoints that will be configurable for this Tuning Graph. You can also add a short description to each Setpoint that will be visible in the Aero<sup>CT</sup> app.

All Tuning Graphs require a name, which must be set in the Name box at the top of the Add AeroCT Tuning Graph dialog.

When the Tuning Graph is configured, click OK to close the Add AeroCT Tuning Graph dialog and return to the AeroCT configuration dialog

When all required points and setpoints have been selected, click OK to close the AeroCT configuration dialog.

To send the Aero<sup>CT</sup> configuration to the controller, carry out a Strategy Download.

## 13 Appendix :: Configuring Units of Measurement and State Strings

### ADDING UNITS OF MEASUREMENT

Additional units of measurement may be added to the existing list of units in a site to allow for a greater range of applications. Units must be added to the `site.ini` file in the `C:\CXproHD\(SITENAME)\SYSTEM` directory

**Note:** Before changing the `site.ini` file, make a backup copy (for example, `site.ini.bak`).

The `site.ini` file can be edited in a word-processing program such as Microsoft Windows Notepad, or Microsoft Word. If you use Word to edit the file, make sure to save the file as a "Text Only" document.

### HOW TO ADD UNITS OF MEASUREMENT TO THE SYSTEM

- Make a backup copy of `site.ini`.
- Open `site.ini`, using a word processing program.
- Search for the `[AnalogUnits]` section if adding analog units, and the `[DigitalUnits]` section if adding digital units.
- Either
  - edit one of the entries marked "spare"
- (e.g. change `UNITS61="Spare1"` to something like `UNITS61="m/s"`)
- or
  - append the new units to the list of units
- (for example, add something like `UNITS74="m/s"` to the end of the list of analog units).
- If you add to the list in this manner, be sure also to increment the `NumberUnits` parameter so that it matches the final number of units. Ensure the number at the end of the units variable (e.g. `UNITS74`) has a number at the end that matches its place in the list of units.
- Save the amended `site.ini` file.
- Close and restart CXpro<sup>HD</sup>, to allow the changes to take effect. The new units can then be selected from list boxes for point configurations.

**EXAMPLE OF ADDING UNITS TO ANALOG UNITS LIST**

Old analog units list:	New list after changing:
<pre>[AnalogUnits] NumberUnits=19 Title="IU" UNITS1=" " UNITS2=" %" UNITS3=" %rH" UNITS4=" °C" UNITS5=" Bits" UNITS6=" g/kg" UNITS7=" Hz" UNITS8=" kJ/kg" UNITS9=" kWh" UNITS10=" L/s" UNITS11=" Min" UNITS12=" mV" UNITS13=" Pa" UNITS14=" Sek" UNITS15=" Std" UNITS16=" Volt" UNITS17=" bar" UNITS18=" K" UNITS19=" Uhr"</pre>	<pre>[AnalogUnits] NumberUnits=21 Title="Unit " UNITS1=" " UNITS2=" %" UNITS3=" %rH" UNITS4=" °C" UNITS5=" Bits" UNITS6=" g/kg" UNITS7=" Hz" UNITS8=" kJ/kg" UNITS9=" kWh" UNITS10=" L/s" UNITS11=" Min" UNITS12=" mV" UNITS13=" Pa" UNITS14=" Sek" UNITS15=" Std" UNITS16=" Volt" UNITS17=" bar" UNITS18=" K" UNITS19=" Uhr" UNITS20=" m/s" UNITS21=" kg/m3"</pre>

**Note:** Units are also listed in the C:\CXproHDCXpro<sup>HD</sup>\SYSTEM\WN3000.ini. However, this file is for legacy applications only and applies throughout the CXpro<sup>HD</sup> system, and so must not be edited.

**Note:** Take care when editing site.ini not to change the section headings [AnalogUnits], [DigitalUnits], etc. in any way, because this can cause errors in the CXpro<sup>HD</sup> system.

## CONFIGURING STATE TEXT STRINGS

The State Text strings are strings that can be displayed in the front end to represent the value of a Multi-state Value object. These strings can be configured (per strategy) as follows:

On the **Strategy** tab of the CXpro<sup>HD</sup> Ribbon, click **Edit State Text** to open the **Edit State Text** dialog.

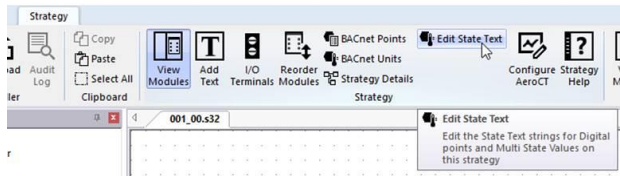

This dialog will show all State Text strings for the current strategy.

These strings are also used for the Low and High units of Digital Setpoints, Digital Hardware Points, and Digital Virtual Points.

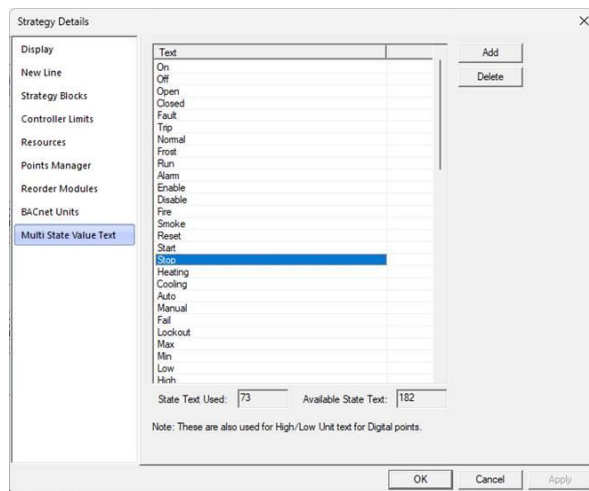

To add a new string, click the **Add** button.

To delete an existing string, select the string and click the **Delete** button

# 14 Appendix :: File Management

## FILE MANAGEMENT IN CXPRO<sup>HD</sup>

On a large site with multiple BACnet Routers where more than one engineer will be commissioning software at any one-time file management becomes very important.

You must ensure that no one modifies the same strategies / global files that an engineer is currently commissioning. To guard against this, we would recommend that all files are stored on a central computer and only the files required for commissioning are copied onto the engineer's laptop. We would also recommend that each engineer is allocated a single BACnet Router to work on at any one time. At the end of each day/commissioning period, the data files for the BACnet Router are copied back onto the central computer.

The data files required to commission a single LAN are as follows:

```
C:\CXproHDCXproHD\ [SiteName]\dbase \*
```

Where \* is the address of the BACnet Router to be commissioned.

All files under

```
C:\CXproHDCXproHD\ [SiteName]\strat5\***
```

Where \*\*\* is the address of the BACnet Router to be commissioned.

The same files should be copied back to the central computer at the end of each day/commissioning period.



# 15 Appendix :: BACnet Explorers

CXpro<sup>HD</sup> includes two utilities that facilitate the commissioning of BACnet Sites: the integrated Discovery Tool, accessible from the Site Tree, and the separate application NB-Pro.

## NB-PRO

NB-Pro is a generic commissioning environment for BACnet controllers. Using NB-Pro, users can setup and configure devices to create control programs and strategies for building automation systems, including ABB Cylon<sup>®</sup> BACnet. For details see *MAN0122 NB-Link & NB-Pro*.

**Note:** For NB-Pro to work with CXpro<sup>HD</sup>, you must open the Settings menu NB-Pro and select Network Configuration. In the Network Configuration dialog, select the Remote IP radio button in the Communicate Via: section so that NB-Pro does not attach to the BACnet UDP port of the PC as this would block CXpro<sup>HD</sup>. Also, register NB-Pro as a foreign device on a CBR on the network by entering the CBR's IP address in the Network Configuration dialog's BBMD Device field.

## DISCOVERY TOOL

The purpose of the Discovery Tool is to allow users to see all live BACnet devices, objects, and properties on the network via CXpro<sup>HD</sup>. It also allows some or all of the discovered objects to be added to an existing Engineering Centre Site or allow a new Site to be created with the discovered objects.

For existing sites, this tool is used to compare the site configuration with the devices that are live on the network. It is possible to change the `present_value` property of some objects.

## BACNET EXPLORER

The Explorer is an extension of the Discovery Tool. It is available in CXpro<sup>HD</sup> by right-clicking on a BACnet Site in the Site Tree and selecting Discover Site.

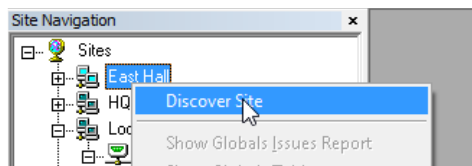

This opens the Site Discovery dialog, which is prefilled with the selected Site's information:

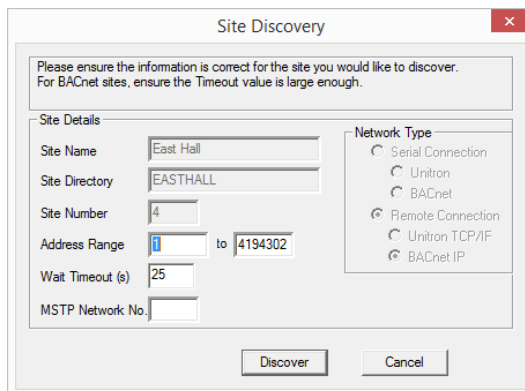

If the Discover Site option is selected from the context menu of the Site Tree's root node,



then the Site Discovery dialog will be blank and can be used to create a new Site.

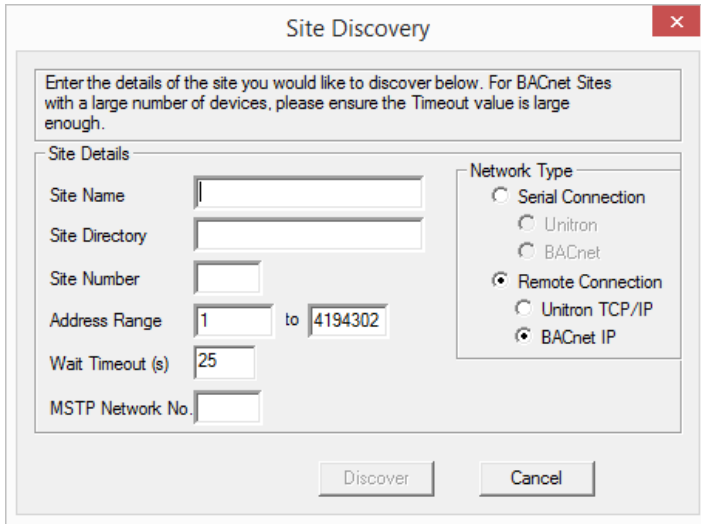

The Site Discovery dialog has the following fields:

### Network Type

(If an existing Site is selected, this selection cannot be changed).

If a site is not selected, select a Network Type that will apply if you choose to create a site from the Explorer during the current exploration:

- Network 1 for Serial and Modem Sites
- Network 2 for TCP/IP or BACnet Sites

### Site Name

(If an existing Site is selected, this field will not be editable).

If a site is not selected, enter a new Site Name here. If you choose to create a site from the Explorer during the current exploration, this is the name that will be used for it.

### Site Directory

The Site Directory is automatically generated from the Site Name, but it can also be user-defined. Do not use special characters in the Site Directory Name.

### Site Number

(If an existing Site is selected, this field will not be editable).

If a site is not selected, specify a Site Number. If you choose to create a site from the Explorer during the current exploration, this is the Site Number that will be used for it.

### Address Range

This can be used to limit the Discovery process. Only BACnet addresses within this range will be tested.

### Wait Timeout (s)

This sets the length of time that the process will listen for I-Am responses during discovery.

Larger Sites require higher Wait Timeout(s) to explore the entire site (default 10 seconds)

### Network

The user can choose a specific network to discover in this dialog box. If the user enters a network number, only devices on that network will be displayed. Leave this blank if you want to show devices on all networks.

The Discover button will launch the progress dialog.

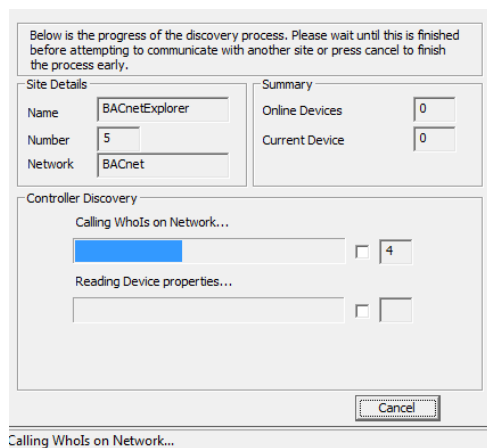

A WhoIs call is made, and then the system waits for the specified timeout (default is 10 seconds) after which it reads the BACnet information for each Device that responded with an I-Am message. When this is complete, the results dialog opens:

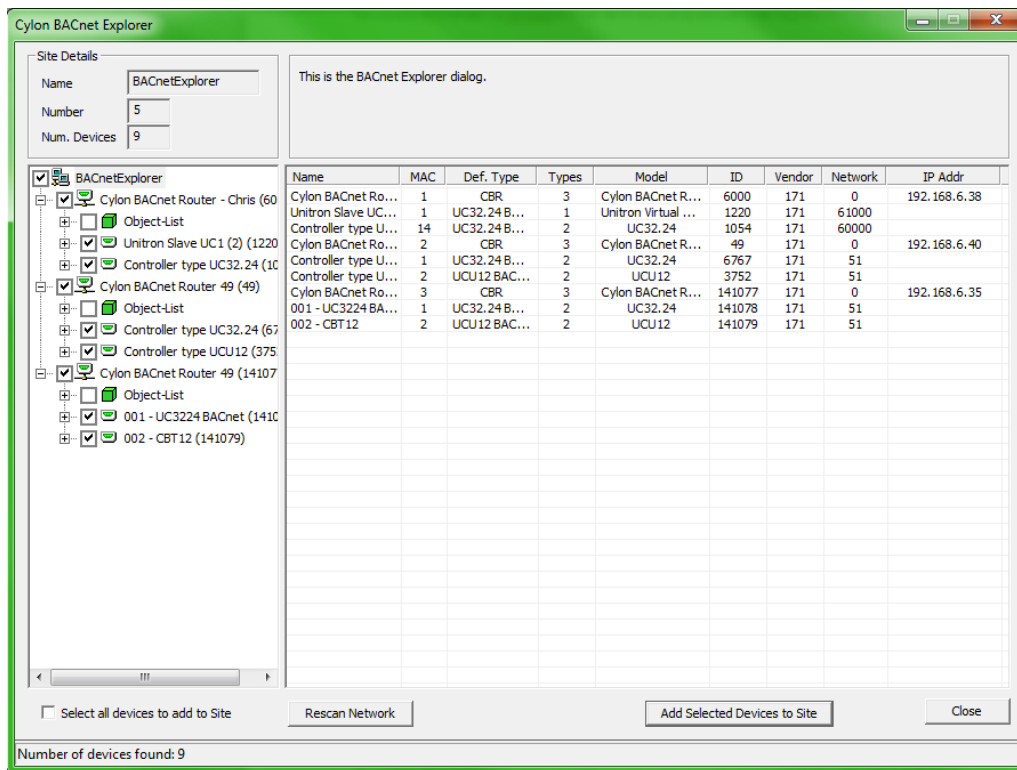

The results dialog contains two panels:

- The left panel contains a tree view list of the BACnet devices and objects discovered.
- The right contains information regarding the selected device or object.

It is possible that not all devices would be discovered during the specified **Wait Timeout(s)**, so if necessary you can re-scan the network for further devices by clicking the **Rescan Network** button. The Site Details dialog will open again so that the settings for **Address Range**, **Wait Timeout(s)** and **Network** number can be adjusted. Devices that have already been discovered will be skipped, so that further devices may be discovered even if none of the settings are changed.

The tree view is similar to the existing site list in other applications. The site is the root node of the tree, followed by the routers and then devices under those. Under the device nodes, there are other nodes in the Object List. Expanding this will show each object read in from the parent device.

As an extension of the **Site Discovery Tool**, the Explorer allows devices to be added to the Site specified in the top left corner of the **CXpro<sup>HD</sup> BACnet Explorer** dialog (which may be an existing site or a new site that will be created when devices are added).

To add devices to the selected site, check the box beside each required device in the Site Tree and click on the **Add Selected Devices to Site** button. To quickly select all of the discovered devices check the **Select all devices to add to Site** box beneath the Site Tree. Non-**ABB Cylon<sup>®</sup>** devices will be added as virtual controllers and have a **CXpro<sup>HD</sup>** address of 131 or above.

When the root of the tree view is selected, the right panel contains a list of the BACnet devices found, along with: **device name**, **MAC address**, **vendor ID**, **model name**, **IP or MSTP Address**, **Network**, and estimated **Controller Type**.

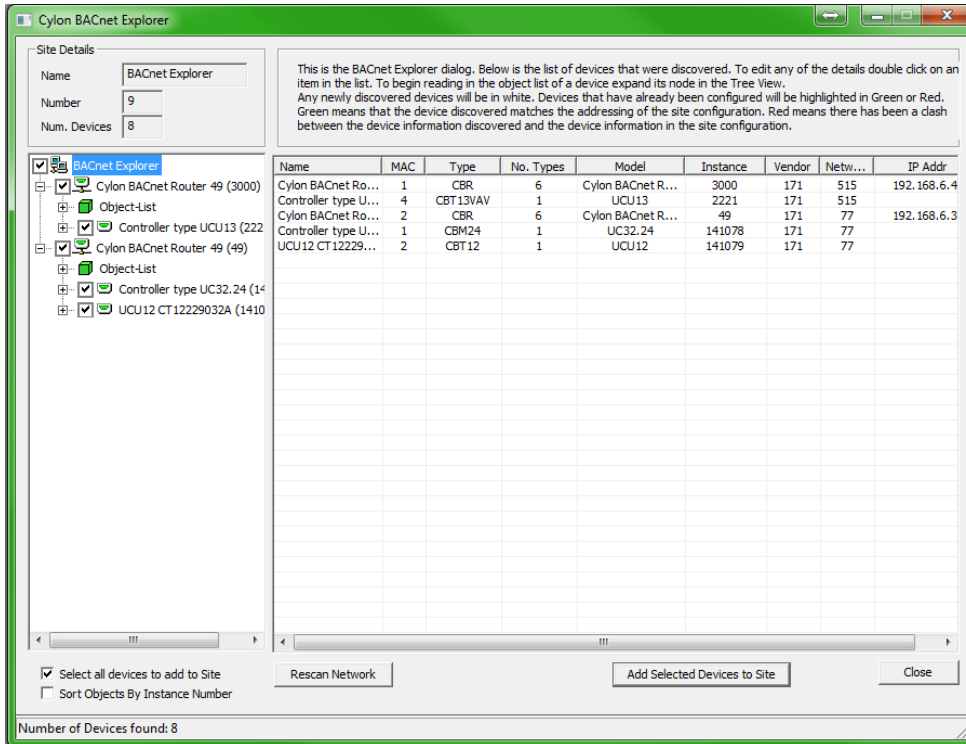

There is also a column (**No. Types**) which shows the number of possible **ABB Cylon**<sup>®</sup> controller types this device could be.

**ABB Cylon**<sup>®</sup> devices are initially set as a **CBM24** controller type, but this can be changed in the **Controller Properties** dialog. The 'Type' of a non-**Cylon**<sup>®</sup> device cannot be changed in the **Controller Properties** dialog, but if they are added to the Site, they will appear as **CBM24** in **CXpro<sup>HD</sup>**, and this can be changed in the **Configuration utility (CCConfig)**.

To open the **Controller Properties** dialog, double-click on the device in the right-hand panel.

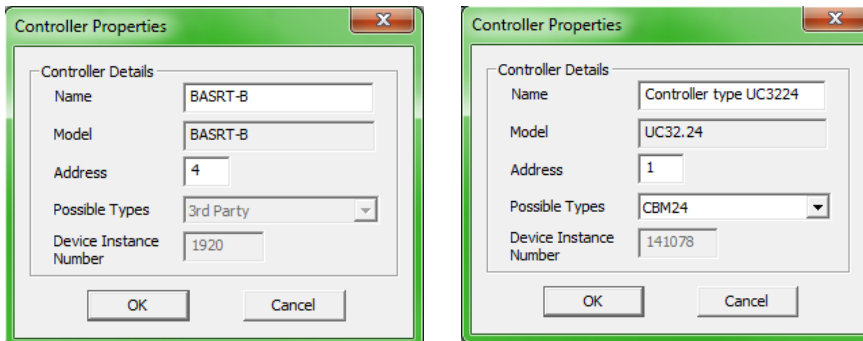

You can then change the **Name**, **Type**, **Address**, and **Device Instance Number** before adding them to the site.

**Note:** This will only change the name of the device in the database on the PC, it will not change the name on the device itself.

When the device node of the tree is expanded or double-clicked, the object list of that device will be read in. As each object is received from the device it will be added as a child to that device node. At this stage, the right-hand panel will display the object list with a column for **object ID**, **object type**, **object name**, and **present value** and this list will be populated as objects are read in.

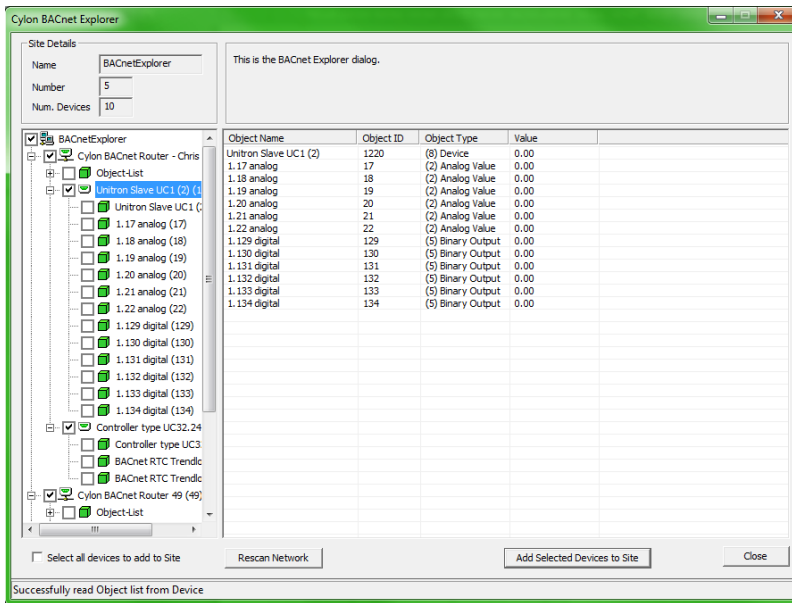

When an object is selected in the tree view, the properties of that object will be read from the device and the right-hand panel will contain the properties and values of that object.

From the results dialog, the user will be able to change the present value property for some of the objects.

**Note:** To refresh a specific object, right-click on that object.

## CHECK AGAINST EXISTING DEVICES

When using the **BACnet Explorer** on an existing site, any discovered devices must be checked against those that have already been configured. This is done by comparing the Device Instance Number of each discovered device against the Device Instance Number of any devices on the site configuration already.

For any discovered devices that have the same Device Instance Number as a device on the PC, there will be a comparison made between the MAC address discovered and the **CXpro<sup>HD</sup>** address.

- If these match, the device will be highlighted in the list in green to signify that the devices match. A matching device cannot be edited.
- If they do not match, then the device in the list control will be highlighted in red to alert the user to this mismatch. The user will be given a choice to resolve the mismatch
- If the Device Instance Number does not match any other ID on the PC, then this discovered device will not be highlighted and will be left white. Non-matching devices can be edited.

## CHANGING THE PRESENT\_VALUE PROPERTY

The present value can only be written to commandable BACnet objects. Commandable objects always have the 'present\_value' property and two additional properties – *Priority\_Array* and *Relinquish\_Default*.

- Analog Output, Binary Output, and Multi-State Output objects are always commandable.
- Analog Value, Binary Value, and MultiState Value objects can be commandable, but this is decided by the vendor.

To change the present value of a commandable object, double-click on the present value property in the right panel. If the object has the required properties, this will open the **Change Present Value Dialog**:

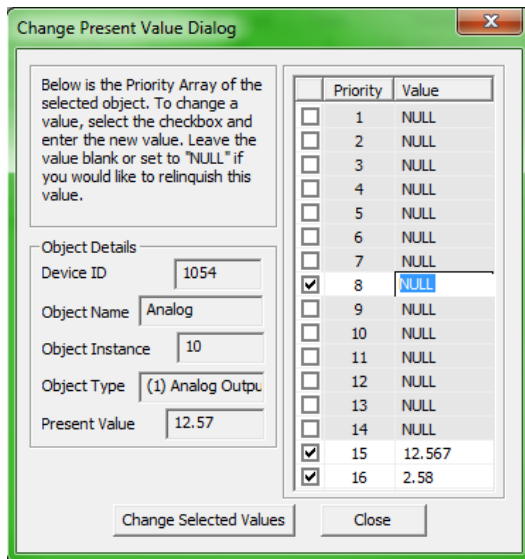

The table on the right-hand side of this dialog shows the current priority array of the object. To change or relinquish the value, you must select the checkbox beside the relevant priority index. By selecting the checkbox, you can edit the value at that array. To relinquish that value, clear the contents in the box or set it to "NULL".

When the **Change Selected Values** button is clicked, the value for any priorities whose checkbox is ticked will be sent to the BACnet object. This will update the priority array on the device and to show this, the list items, *present\_value* and *priority\_array*, in the Explorer dialog will be updated too.

## 16 Commissioning Controllers with CXpro<sup>HD</sup>

### HOW TO CONFIGURE A CONTROLLER'S BACNET SETTINGS

When a Field Controller is first commissioned, its address must be set by connecting CXpro<sup>HD</sup> directly to the controller by RS232 link (Service Port). If points on the controller are to be exposed on a BACnet network, or if CXpro<sup>HD</sup> is to communicate with the Field Controller by BACnet Tunneling, then the Field Controller's BACnet address (Device Instance Number) must also be set.

These device settings, and others, can be set from CXpro<sup>HD</sup> as follows:

**Note:** Some parameters can be set over Ethernet connection, but Controller Address and Baud Rate can **only** be set when the Engineering PC is connected to the controller by RS232 link.

In CXpro<sup>HD</sup>, select BACnet Configuration from the Controller tab of the Ribbon

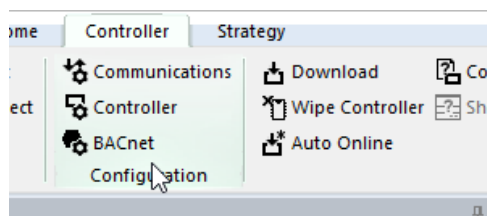

This opens the BACnet Configuration dialog, which defines how the Controller will communicate on the BACnet network, and how it will communicate with CXpro<sup>HD</sup> for configuration over BACnet.

In this dialog, each current value and the proposed new values can both be displayed at once. Defaults can also be automatically generated.

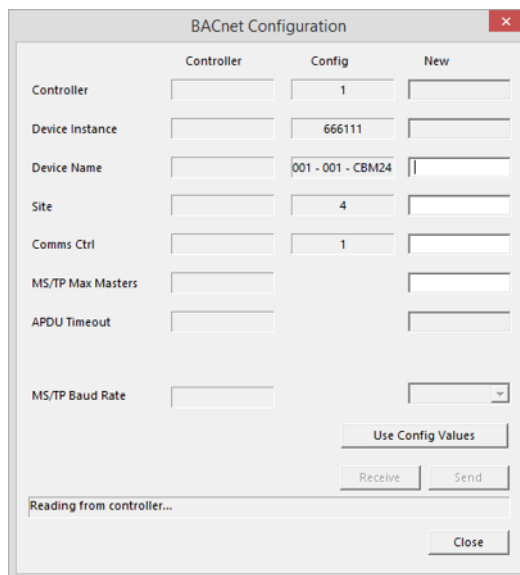

**Note:** Only Device Name, Router Address, and MSTP Max Masters will be editable when the Engineering PC is connected over Ethernet. In order to edit the other parameters, it must be connected by RS232 serial link.



The parameters that define how the Controller communicates on the BACnet system are:

## Device Instance

Enter the required BACnet address (0 – 4194303).

**Note:** The number set here in the Field Controller (when connected serially) must match the Device Instance Number set in CXpro<sup>HD</sup>.

## Device Name

Any descriptive text.

## Tunneling Properties: Site and Comms Ctrl

**Note:** All of the ABB Cylon<sup>®</sup> controllers throughout the BACnet system **must** have the same CXpro<sup>HD</sup> “Site Number”.

In the Device Properties dialog set the Site and Comms Ctrl matching the position of this Controller in the Site defined in CXpro<sup>HD</sup>.

## MSTP Max Masters

This must be equal to or greater than the highest address used on the BACnet MS/TP fieldbus, because this controller will not pass data to devices with addresses higher than this. The optimum situation is that this value is set in all devices to exactly the value of the highest address on the fieldbus. (1 - 127)

**Note:** It is recommended that you address your controllers consecutively starting at 1, with the MAX Master value matching the Maximum Controller address value. For optimum efficiency, there should be no gaps in the device addresses.

## APDU Timeout

(0 ... 60 seconds) this value should be left at its default unless there is a problem.

## COMMISSIONING A RANGE OF CONTROLLERS QUICKLY (MASS COMMISSIONING)

CXpro<sup>HD</sup> includes a utility to quickly commission the MAC, Max Masters, Device IDs and Names of **ABB Cylon<sup>®</sup>** controllers.

This utility is available through either the **Commission MS/TP Devices** and the **Commission MS/TP Network** options. The IP device option is only available at the Site level, and configures only **CBXi**, **FBXi** and **FBVi** controllers.

To open the BACnet commissioning utility, right-click on a Site or a Router in the Site List:

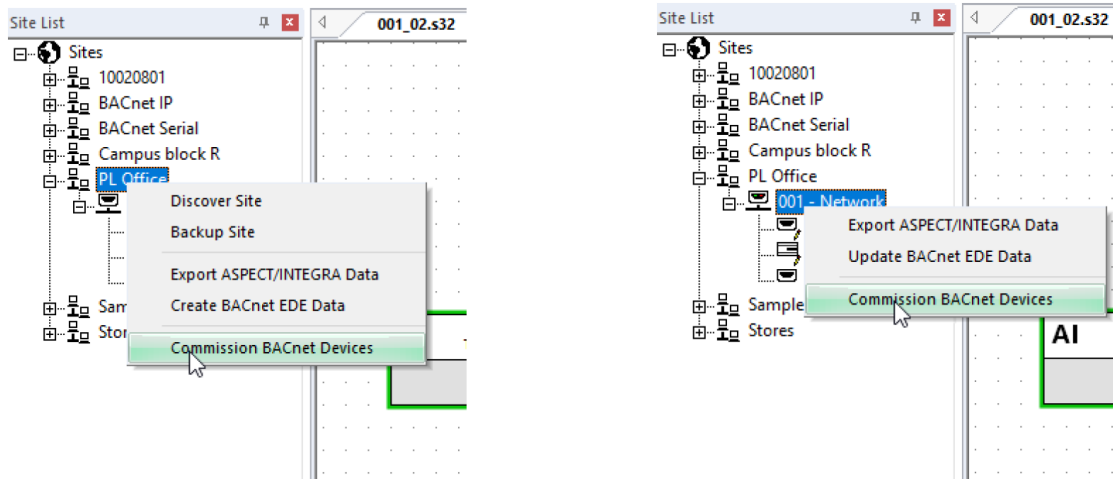

**Note:** The devices must be configured within CXpro<sup>HD</sup> before they can be accessed by this utility.

**Note:** For IP commissioning (i.e. if the **Commission BACnet Devices** dialog was opened with the **Commission IP Devices** option), then in order for controller parameters to be editable, discovered devices must first be associated with configured devices as described in *How to Associate devices* on page 222.

If launched from a router, only the devices on that subnet will be pinged. If launched from the site, all devices on the site will be pinged.

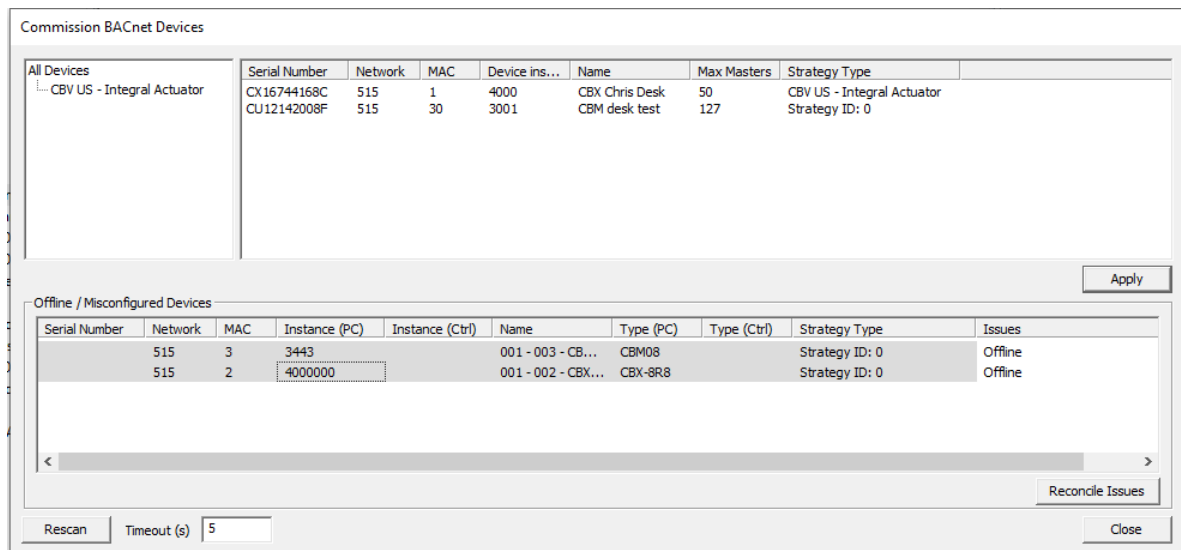

When pinging is complete, the Commission BACnet Devices dialog is displayed:

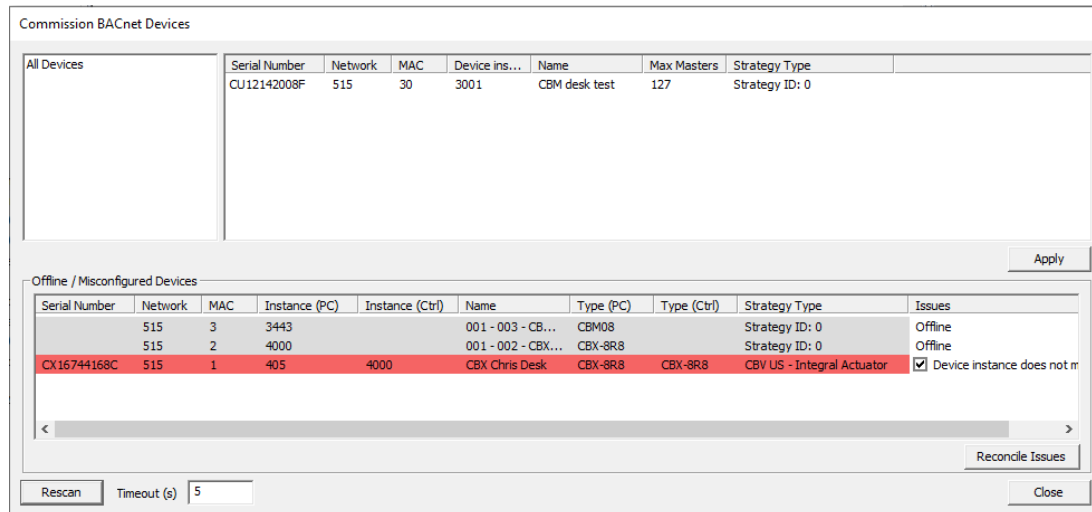

The upper-right pane of the Commission BACnet Devices dialog lists all of the devices configured in the CXpro<sup>HD</sup> Site that have been successfully discovered on the BACnet network.

The lower pane of the Commission BACnet Devices dialog lists devices that are configured in the CXpro<sup>HD</sup> Site but have **not** been successfully identified on the BACnet network. Devices that partially match the CXpro<sup>HD</sup> Site configuration are highlighted in red – for example, a device has been found that matches the MS/TP Network Number and MAC Address of a configured device, but the Device Instance Number does not match.

If you want any of the devices highlighted in red to be included in the Commissioning process, tick the checkbox to the right of red highlight. When all such devices have been selected, click the Reconcile Issues button.

The configuration of the device in the CXpro<sup>HD</sup> Site will be updated to match the corresponding discovered device, and the device listing will move to the top-right pane:

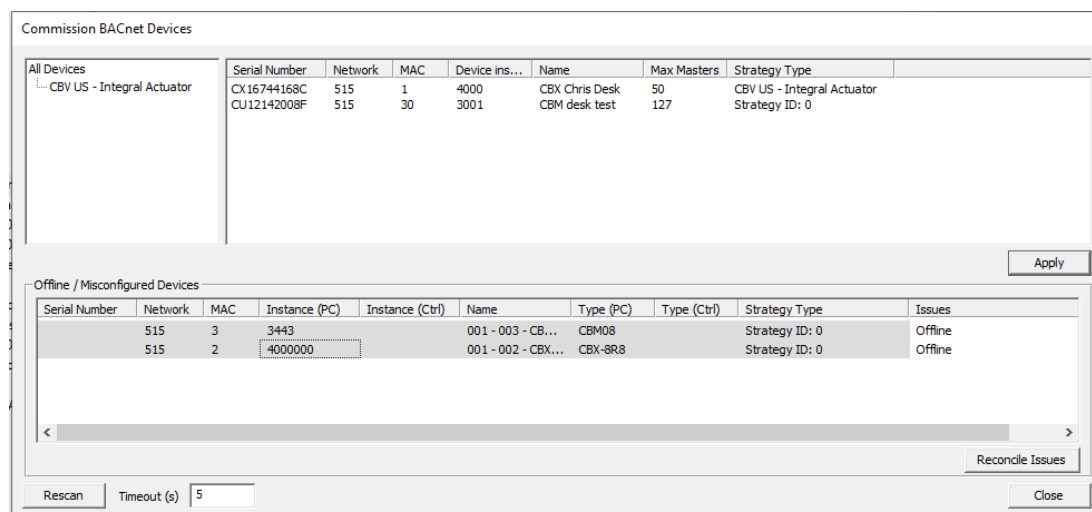

**Note:** If reconciling might create duplicate IDs, the conflicting offline devices are renumbered to a value above 4000000 to ensure that they will be unique.

If no match is found for the MS/TP Network Number and MAC Address of a configured device, that device is listed in the lower pane as *Offline*, marked with a grey background and cannot be included in the Reconcile Issues process.

To retry pinging offline devices, click the Rescan button on the bottom left of the dialog.

The upper-left pane of the **Commission BACnet Devices** dialog shows categorized devices found organized by strategy ID.

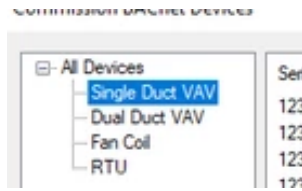

This groups devices by the type of strategy they contain (e.g. single or dual duct VAV, or RTUs, Fancoils, etc), so that common properties can be edited together.

Clicking on **All devices** will show only the properties that are common to all devices of **MAC**, **Max Masters**, **Device ID**, **Name**, **Serial Number**, and **strategy Type**.

Clicking on a strategy type in the left-hand pane means that additional parameters common to that strategy type will become available in the right-hand pane:

Serial Number	MAC	Max Masters	Device ID	Name	Type	Input Config	Output Config
12345671	1	127	12341	VAVST386	137	48	18
12345672	2	127	12342	VAVST388	137	48	18
12345673	3	127	12343	VAVST390	137	48	18
12345674	4	127	12344	VAVST392	137	48	18
12345675	5	127	12345	VAVST394	137	48	18
12345676	6	7	12346	VAVST396	137	48	18

Each of the fields can be edited individually.

However, it is also possible to copy a single value to multiple controllers at once, so that device types that are installed identically - for example, VAVs – can be configured in bulk very quickly (similar to copy & paste in a spreadsheet program).

When appropriate, editing a single field will be assisted by a properties window that indicates what the setting value will mean:

When all of the fields have been configured, click the **Apply** button, and the full set of edited parameters will be sent to all controllers. A progress dialog will be displayed, indicating progress and highlighting any failures:

Serial N.	MAC	Max Masters	Device ID	Name	Progress
12345671	1	127	12341	VAVST386	Complete
12345672	2	127	12342	VAVST388	Controller write failure.
12345673	3	127	12343	VAVST390	Complete
12345674	4	127	12344	VAVST392	In Progress
12345675	5	127	12345	VAVST394	
12345676	6	7	12346	VAVST396	

## CONFIGURE A SINGLE CONTROLLER

In addition to Mass Commissioning, it is possible to configure an individual controller without re-running. This can be useful if for example a mistake was made on a few controllers during Mass Commissioning, or if circumstances change and a small number of controllers must be changed.

To commission a specific controller, right-click on it in the **Site Tree**, and select **Configure this Controller**.

CXpro<sup>HD</sup> attempts to communicate with the controller, find its serial number and read its strategy ID. If CXpro<sup>HD</sup> cannot communicate with the controller, a warning will be displayed and the dialog will close. Otherwise, CXpro<sup>HD</sup> will show a **Config Properties** dialog:

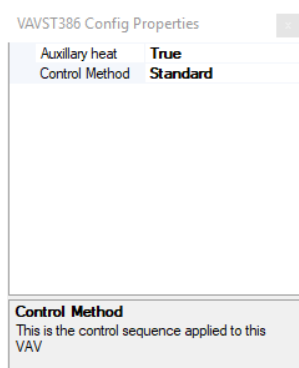

When the properties are set, click the **Apply** button to send the configuration and close the dialog.

**Note:** If strategy ID is not known, only device name, ID, and a few other properties are editable. e.g. for IP Device:

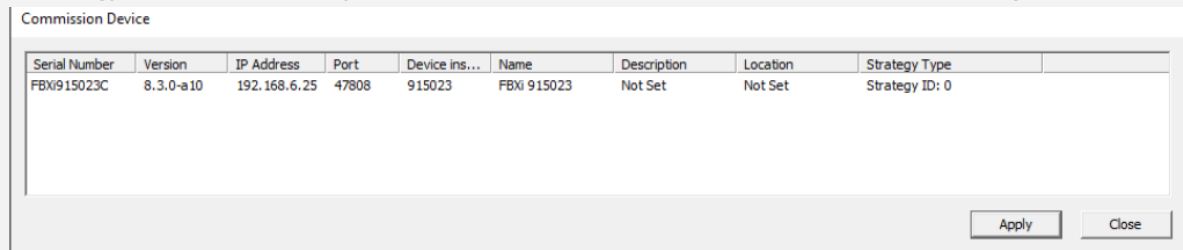

If strategy ID is known, user can edit the configuration point values in the same way as for mass commissioning. e.g. for MS/TP Device:

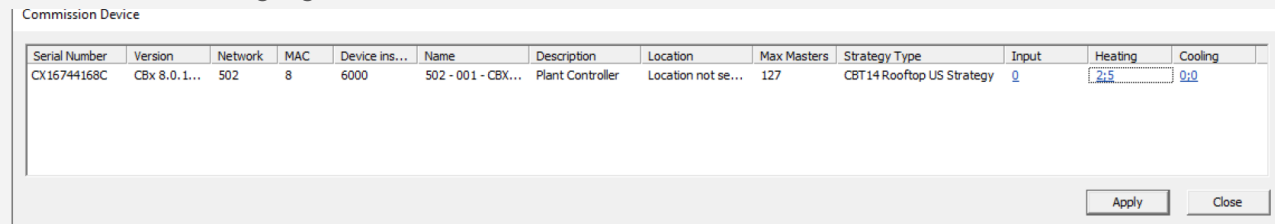

## CONFIGURE IP BACNET DEVICE PROPERTIES

CXpro<sup>HD</sup> includes a utility to quickly configure BACnet properties for IP devices. To launch this utility, right-click on a Site in the **Site List** and select **Configure IP BACnet Device Properties**

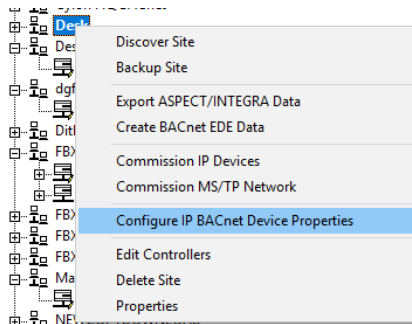

The utility will scan for all CBXi, FBXi and FBVi devices on the selected network.

**Note:** The devices must be configured within CXpro<sup>HD</sup> before they can be accessed by this utility.

When scanning is complete, the **Associate IP Devices** dialog will open:

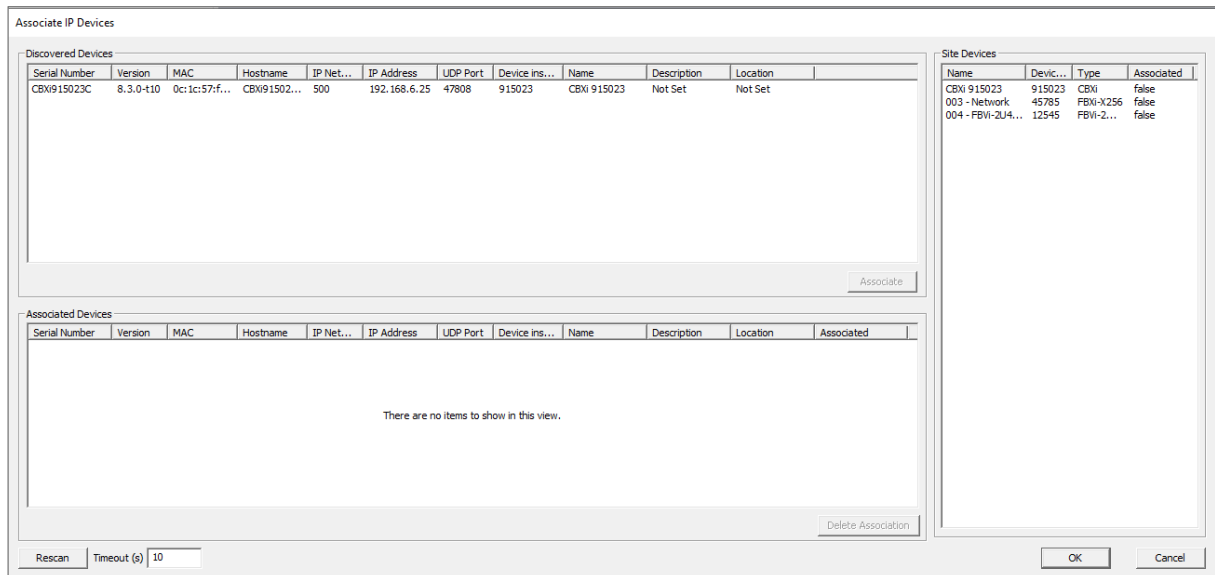

The **Site Devices** panel on the right lists all of the relevant IP devices configured in the CXpro<sup>HD</sup> Site that have been successfully discovered on the BACnet network.

The **Discovered Devices** panel on the top left lists all of the relevant devices that have been discovered on the network

The **Associated Devices** panel on the bottom left lists any Discovered Device that has been associated with a configured Site Device.

## HOW TO ASSOCIATE DEVICES

To associate a Discovered Device with a Site Device, select a device in the **Site Devices** list and a device in the **Discovered Devices** list and click the **Associate** button. Alternatively, you can drag the Site Device and drop it over a Discovered Device.

Once this is done, the discovered device is moved to the **Associated Devices** list. The device on the Site PC is updated with the Device Instance of the physical devices.

The MAC address will be stored in the site configuration as the key, so associations are maintained if the tool is run again.

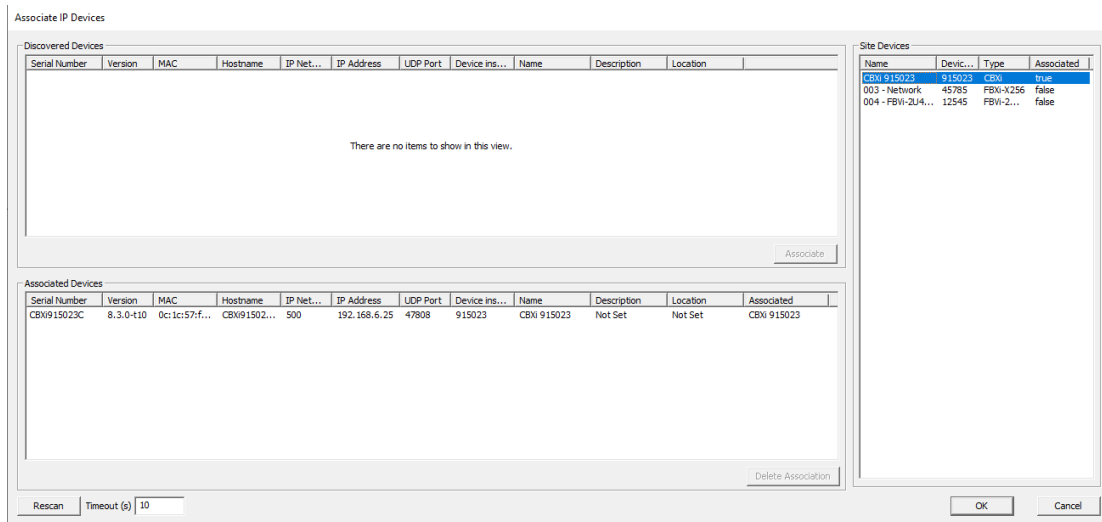

When all required devices have been associated, click **OK** to open the **Configure IP device** dialog where the IP Properties of Associated devices can be edited.

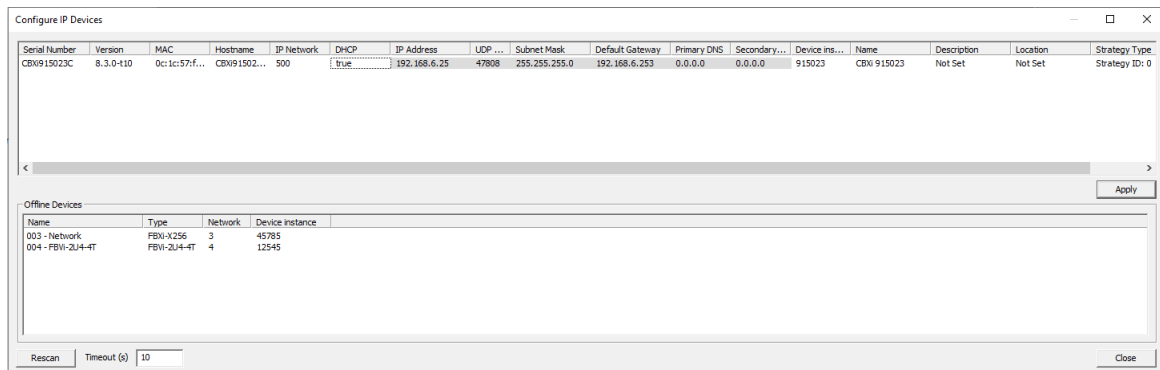

The list on the bottom shows the unassociated or offline devices.

When the properties are set as required, click **Apply** to send the changes to that controller.



---

**ABB CYLON CONTROLS**

Clonshaugh Business & Technology  
Park  
Clonshaugh  
Dublin 17  
Ireland

Tel.: +353 1 245 0500  
Fax: +353 1 245 0501  
Email: [info@cylon.com](mailto:info@cylon.com)

---

**ABB CYLON CONTROLS**

ONE TECHNOLOGY LANE  
EXPORT,  
PA 15632

Tel.: +1 724 733-2000  
Fax: +1 724 327-6124