

Productinformatieblad

Specificaties

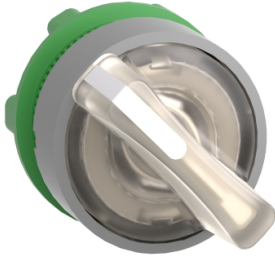

white illum selector switch head 2-position stay put cp grey

ZB5AK1213C0

Belangrijk bericht: A change in appearance may be noted on the product but does not affect its use in terms of function and safety. This makes it compatible with our Universal LED blocks
EAN Code: 3606489767181

Prijs: 21,85 EUR

Hoofd

| | |
|------------------------------------|------------------------------------|
| range of product | Harmony XB5 |
| product of component type | Kop voor verlichte keuzeschakelaar |
| compatibiliteit product | Universele LED |
| device short name | ZB5 |
| kraag materiaal | Kunststof gekleurd grijs |
| bevestigingsdiameter | 22 mm |
| koptype | Standaard |
| verkoop per ondeelbare hoeveelheid | 1 |
| vorm van kop signaleringseenheid | Rond |
| type operator | blijven |
| operator profiel | Wit standaard hendel |
| informatie positie operator | 2 standen 90° |

Complementair

| | |
|--------------------------------|--|
| CAD totale breedte | 29 mm |
| CAD totale hoogte | 29 mm |
| CAD totale diepte | 43 mm |
| gewicht product | 0,016 kg |
| mechanical durability | 1000000 cycles |
| naam station | XALD 1...5 uitsnijdingen XALK 2...5 uitsnijdingen |
| elektrische samenstellingscode | M3 voor <4 contacten gebruik enkelvoudig blokken in vooraan gemonteerd met integrale LED M6 voor <2 contacten gebruik enkelvoudig blokken in vooraan gemonteerd met ingebouwde LED en transformator M10 voor <2 contacten gebruik enkelvoudig blokken in vooraan gemonteerd met integrale LED MF1 voor <2 contacten gebruik enkelvoudig blokken in vooraan gemonteerd met integrale LED MR1 voor <2 contacten gebruik enkelvoudig blokken in montage aan achterzijde met integrale LED M4 voor <4 contacten gebruik enkelvoudig en dubbel blokken in vooraan gemonteerd met integrale LED |
| product presentatie | Basisonderdeel |

Omgeving

De weergegeven prijs is de adviesprijs in euro excl. BTW. Deze kan onderhevig zijn aan korting. Neem contact op met uw lokale distributeur of detailhandel voor de daadwerkelijke prijs

| | |
|---------------------------------------|--|
| beschermende behandeling | TH |
| ambient air temperature for storage | -40...70 °C |
| ambient air temperature for operation | -40...70 °C |
| overvoltage category | Klasse II In overeenstemming met IEC 60536 |
| IP beschermingsgraad | IP66 In overeenstemming met IEC 60529 IP67 |
| Enclosure Type | UL type 4X/13 |
| weerstand hoge druk drukring | 7000000 Pa om 55 °C, afstand: 0.1 m |
| IK-beschermingsgraad | IK04 In overeenstemming met IEC 50102 |
| standards | EN/IEC 60947-5-4 JIS C8201-5-1 CSA C22.2 Nr 14 EN/IEC 60947-5-1 EN/IEC 60947-5-5 UL 508 EN/IEC 60947-1 JIS C8201-1 |
| product certifications | CSA DNV BV LROS (Lloyds register of shipping) UL listed |
| trilling bestendigheid | 5 gn (f= 2...500 Hz) In overeenstemming met IEC 60068-2-6 |
| schokbestendigheid | 30 gn (duur = 18 ms) voor halve sinusgolf versnelling In overeenstemming met IEC 60068-2-27 50 gn (duur = 11 ms) voor halve sinusgolf versnelling In overeenstemming met IEC 60068-2-27 |

Verpakkingseenheid

| | |
|---------------------------------|--------|
| Eenheidstype van verpakking 1 | PCE |
| Aantal eenheden in verpakking 1 | 1 |
| verpakking 1 hoogte | 4,2 cm |
| verpakking 1 breedte | 3,3 cm |
| verpakking 1 lengte | 5,2 cm |
| verpakking_1_gewicht | 23,0 g |

contractuele waarborg

| | |
|-----------------------|----|
| Garantie (in maanden) | 18 |
|-----------------------|----|

Schneider Electric wil tegen 2050 de Net Zero-status hebben bereikt via partnerschappen in de toeleveringsketen, materialen met een lagere impact en circulariteit via onze doorlopende campagne "Use Better, Use Longer, Use Again" om de levensduur van producten en de recycleerbaarheid te verlengen.

[Uitleg van Environmental Data >](#)

[Hoe evalueren we de duurzaamheid van producten? >](#)

Milieuoetafdruk

Milieu Profiel

[Milieuprofiel van het product](#)

Use Better

Materialen en verpakking

Pakket met gerecycleerd karton

Ja

Verpakkingen zonder kunststof

Ja

RoHS-richtlijn van de EU

[Conform](#)

REACH-verordening

[Referentie bevat geen SVHC boven drempelwaarde](#)

Use Longer

Levensduurverlenging

Reparatie

Nee

Use Again

Herverpakken en herfabriceren

Circulair Profiel

[Informatie over einde levensduur](#)

Terugname

Ja

Dimensions Drawings

Dimensions



Mounting and Clearance

Panel Cut-out for Pushbuttons, Switches and Pilot Lights (Finished Holes, Ready for Installation)

Connection by Screw Clamp Terminals or Plug-in Connectors or on Printed Circuit Board

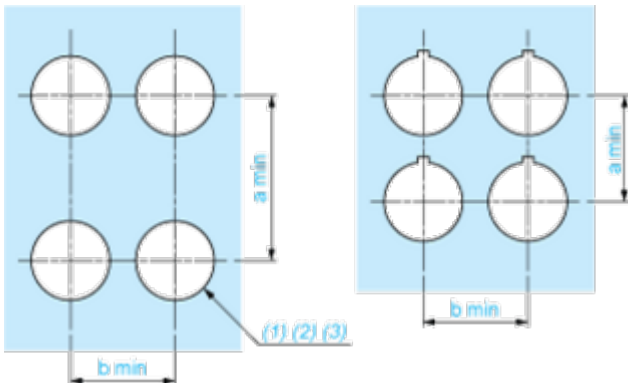

- (1) Diameter on finished panel or support
- (2) For selector switches and Emergency stop buttons, use of an anti-rotation plate type ZB5AZ902 is recommended.
- (3) $\varnothing 22.5$ mm recommended ($\varnothing 22.3 \text{ }_0^{+0.4}$) / $\varnothing 0.89$ in. recommended ($\varnothing 0.88 \text{ in. }_0^{+0.016}$)

| Connections | a in mm | a in in. | b in mm | b in in. |
|---|---------|----------|---------|----------|
| By screw clamp terminals or plug-in connector | 40 | 1.57 | 30 | 1.18 |
| By Faston connectors | 45 | 1.77 | 32 | 1.26 |
| On printed circuit board | 30 | 1.18 | 30 | 1.18 |

Detail of Lug Recess

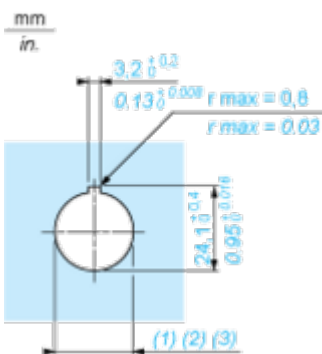

- (1) Diameter on finished panel or support
- (2) For selector switches and Emergency stop buttons, use of an anti-rotation plate type ZB5AZ902 is recommended.
- (3) $\varnothing 22.5$ mm recommended ($\varnothing 22.3 \text{ }_0^{+0.4}$) / $\varnothing 0.89$ in. recommended ($\varnothing 0.88 \text{ in. }_0^{+0.016}$)



A: 1.18 in. min.

B: 1.57 in. min.

General Tolerances of the Panel and Printed Circuit Board

The cumulative tolerance must not exceed 0.3 mm / 0.012 in.: T1 + T2 = 0.3 mm max.

Installation Precautions

- Minimum thickness of circuit board: 1.6 mm / 0.06 in.
- Cut-out diameter: 22.4 mm ± 0.1 / 0.88 in. ± 0.004
- Orientation of body/fixing collar ZB5AZ009: ± 2° 30' (excluding cut-outs marked a and b).
- Tightening torque of screws ZBZ006: 0.6 N.m (5.3 lbf.in) max.
- Allow for one ZB5AZ079 fixing collar/pillar and its fixing screws:
 - every 90 mm / 3.54 in. horizontally (X), and 120 mm / 4.72 in. vertically (Y).
 - with each selector switch head (ZB5AD*, ZB5AJ*, ZB5AG*).

The fixing centers marked a and b are diagonally opposed and must align with those marked 4 and 5.



- (1) Head ZB5AD•
- (2) Panel
- (2) Nut
- (4) Printed circuit board

Mounting of Adapter (Socket) ZBZ01•

- 1 2 elongated holes for ZBZ006 screw access
- 2 1 hole \varnothing 2.4 mm \pm 0.05 / 0.09 in. \pm 0.002 for centring adapter ZBZ01•
- 3 8 \times \varnothing 1.2 mm / 0.05 in. holes
- 4 1 hole \varnothing 2.9 mm \pm 0.05 / 0.11 in. \pm 0.002, for aligning the printed circuit board (with cut-out marked **a**)
- 5 1 elongated hole for aligning the printed circuit board (with cut-out marked **b**)
- 6 4 holes \varnothing 2.4 mm / 0.09 in. for clipping in adapter ZBZ01•

Dimensions An + 18.1 relate to the \varnothing 2.4 mm \pm 0.05 / 0.09 in. \pm 0.002 holes for centring adapter ZBZ01•.

Technical Description

Electrical Composition Corresponding to Code M3

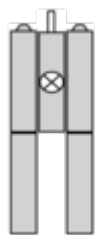

Electrical Composition Corresponding to Code M4



Electrical Composition Corresponding to Codes M6 and P2



Electrical Composition Corresponding to Codes M5, M10, MF1, MR1 and MF2

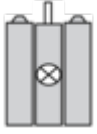

Legend

Single contact



Double contact



Light block



Possible location



Sequence of Contacts Fitted to 2-position Selector Switch Body

Position 315°



| | | | | | |
|------|----------|--------|--------|--|-------|
| Push | Position | Top | | | |
| | | Bottom | | | |
| | Location | | Left | | Right |
| | State | | 0 | | 0 |
| | Contacts | N/O | | | open |
| N/C | | closed | closed | | |

Position 45°



| | | | | | |
|----------|----------|--------|--------|--------|-------|
| Push | Position | Top | | | |
| | | Bottom | | | |
| | Location | | Left | | Right |
| | State | | 1 | | 1 |
| Contacts | N/O | | closed | closed | |
| | N/C | | open | open | |

Technical Illustration

Dimensions

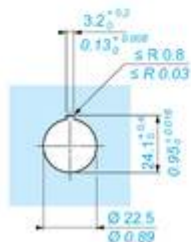
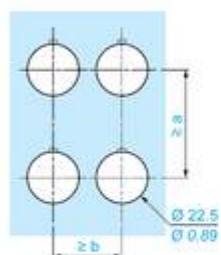
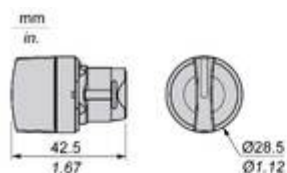

| | | a (mm) | a (in.) | b (mm) | b (in.) |
|-----------|-----------|--------|---------|--------|---------|
| | | 40 | 1.57 | 30 | 1.18 |
| ZBE..... | ZBV..... | | | | |
| | | 45 | 1.77 | 32 | 1.26 |
| ZBE.....3 | ZBV.....3 | | | | |
| | | 40 | 1.57 | 30 | 1.18 |
| ZBE.....4 | ZBV.....4 | | | | |
| | | 50 | 1.97 | 30 | 1.18 |
| ZBE.....5 | ZBV.....5 | | | | |
| | | 40 | 1.57 | 30 | 1.18 |
| ZBE.....9 | ZBV.....9 | | | | |
| | | 40 | 1.57 | 30 | 1.18 |
| ZBRT• | ZBRV1 | | | | |

Offer Marketing Illustration

Product benefits / Features

Technical Benefits

Harmony XB5

Conformity with IEC, UL, CSA, CCC EAC, and JIS standards, as well as CE marking and marine approvals

Up to IP66, 67, 69, 69K, and type 4X protection ratings

High vibration resistance with shake-proof terminal screws



Operating temperature from -40°C to 70°C

Shock protection level up to IK06

Secure switching of inductive or heavy DC loads directly – 100 000 operations at 10A, 24V dc

Offer Marketing Illustration

Product benefits / Features



The infographic features a central image of a Schneider XB5 terminal block with a grey cover. It is surrounded by five circular icons, each with a corresponding text description of a feature. The background is a solid green color.

Features Harmony XB5

-  Quick and easy assembly and disassembly
-  Excellent mechanical connection with operator head
-  Various types of connection: screw clamp, connector, Faston connector, spring terminal, or printed circuit board
-  Large set of accessories to customize your panels
-  Robustness to withstand harsh environments

Image of product / Alternate images

Alternative

