

## Data Sheet | Item Number: 723-602/114-000

1-conductor male connector; CAGE CLAMP®; 2.5 mm²; Pin spacing 7.5 mm; 2-pole;  
100% protected against mismatching; Snap-in flange; 2,50 mm²; light gray

<https://www.wago.com/723-602/114-000>



Color: ■ light gray

Similar to illustration

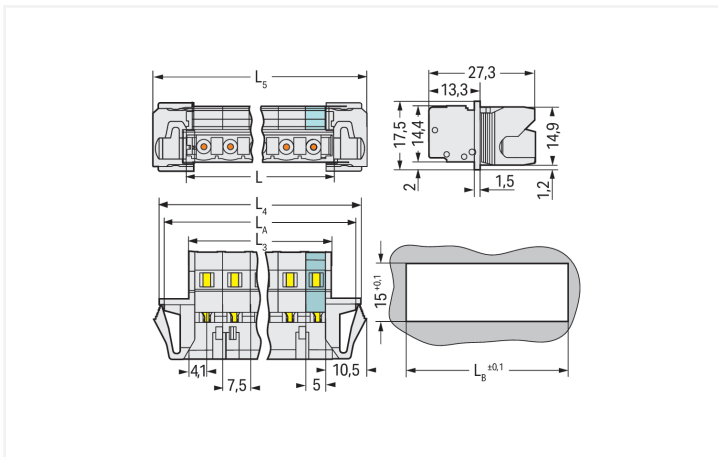
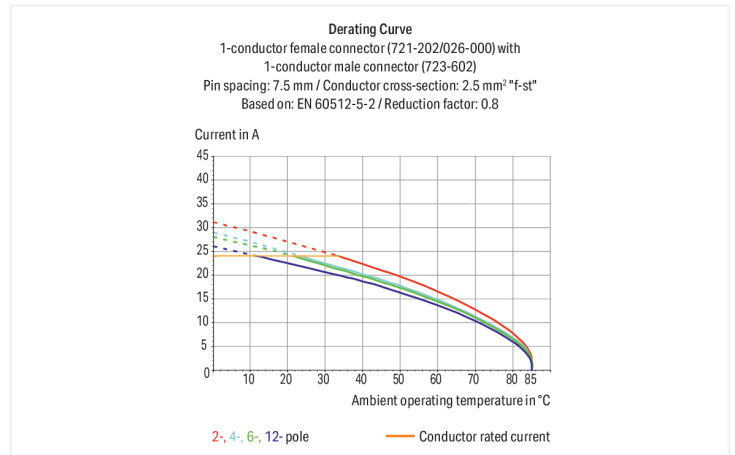

Dimensions in mm

$L = (\text{pole no.} - 1) \times \text{pin spacing} + 8.2 \text{ mm}$   
 $L_3 = L - 0.2 \text{ mm}$   
 $L_4 = L_3 + 15.2 \text{ mm}$   
 $L_5 = L_3 + 18 \text{ mm}$   
 $L_A = L_3 + 12.6 \text{ mm}$   
 $L_B = L_3 + 13.2 \text{ mm}$

### Male connector, 723 Series, CAGE CLAMP®

Our male connector (item number 723-602/114-000) simplifies electrical installations. Strip lengths must be between 8 and 9 mm when connecting conductors to this male connector. This product features one conductor terminal and utilizes CAGE CLAMP®. Our proven universal connection technology known as CAGE CLAMP® is the industry standard when it comes to connection technology and electrical interconnections. Dimensions: (33.5 x 17.5 x 27.5) mm (width x height x depth). Depending on the type of conductor, this male connector is ideal for conductor cross sections ranging from 0.08 mm² to 2.5 mm².

The contact surface is coated with tin.

## Notes

## Safety Information

The MCS – MULTI CONNECTION SYSTEM includes connectors without breaking capacity in accordance with DIN EN 61984. When used as intended, these connectors must not be connected/disconnected when live or under load. When used as intended, these connectors must not be connected/disconnected when live or under load. The circuit design should ensure header pins, which can be touched, are not live when unmated.

## Variants:

Other pole numbers  
Gold-plated or partially gold-plated contact surfaces  
Other versions (or variants) can be requested from WAGO Sales or configured at <https://configurator.wago.com/>.

## Electrical data

Ratings per IEC/EN 60664-1				Approvals per UL 1059			
	III	III	II	Use group	B	C	D
Overvoltage category	III	III	II	Rated voltage	300 V	-	300 V
Pollution degree	3	2	2	Rated current	15 A	-	10 A
Nominal voltage	500 V	630 V	1000 V				
Rated impulse withstand voltage	6 kV	6 kV	6 kV				
Rated current	12 A	12 A	12 A				

Approvals per UL 1977	
Rated voltage	600 V
Rated current	15 A

Approvals per CSA			
Use group	B	C	D
Rated voltage	300 V	-	300 V
Rated current	15 A	-	10 A

## Connection Data

Clamping units	2
Total number of potentials	2
Number of connection types	1
Number of levels	1

## Connection 1

Connection technology	CAGE CLAMP®
Actuation type	Operating tool
Actuation direction 1	Operation parallel to conductor entry
Actuation direction 2	Operation perpendicular to conductor entry
Solid conductor	0.08 ... 2.5 mm <sup>2</sup> / 28 ... 12 AWG
Fine-stranded conductor	0.08 ... 2.5 mm <sup>2</sup> / 28 ... 12 AWG
Fine-stranded conductor; with insulated ferrule	0.25 ... 1.5 mm <sup>2</sup>
Fine-stranded conductor; with uninsulated ferrule	0.25 ... 2.5 mm <sup>2</sup>
Strip length	8 ... 9 mm / 0.31 ... 0.35 inches
Pole number	2
Conductor entry direction to mating direction	0°

## Physical data

Pin spacing	7.5 mm / 0.295 inches
Width	33.5 mm / 1.319 inches
Height	17.5 mm / 0.689 inches
Depth	27.5 mm / 1.083 inches

### Mechanical data

Variable coding	Yes
Housing sheet thickness	0.5 ... 3 mm / 0.02 ... 0.118 inches
Mounting type	Snap-in flange
Mounting type	Feed-through mounting
Anti-rotation protection	Yes
Suitable for through-panel applications	Yes

### Plug-in connection

Contact type (pluggable connector)	Male connector/plug
Connector (connection type)	for conductor
Mismatching protection	Yes

### Material data

Note (material data)	<a href="#">Information on material specifications can be found here</a>
Color	light gray
Material group	I
Insulation material (main housing)	Polyamide (PA66)
Flammability class per UL94	V0
Clamping spring material	Chrome-nickel spring steel (CrNi)
Contact material	Electrolytic copper (E <sub>cu</sub> )
Contact Plating	Tin
Fire load	0.14 MJ
Weight	5.9 g

### Environmental requirements

Limit temperature range	-60 ... +100 °C
Processing temperature	-35 ... +60 °C

### Commercial data

Product Group	3 (Multi Conn. System)
PU (SPU)	50 pcs
Packaging type	Box
Country of origin	DE
GTIN	4050821280453
Customs tariff number	85366930000

### Product Classification

UNSPSC	39121409
eCl@ss 10.0	27-44-03-09
eCl@ss 9.0	27-44-03-09
ETIM 9.0	EC002638
ETIM 10.0	EC002638
ECCN	NO US CLASSIFICATION

**Environmental Product Compliance**

RoHS Compliance Status	Compliant, No Exemption
------------------------	-------------------------

**Approvals / Certificates**

**General approvals** **Approvals for marine applications**



Approval	Standard	Certificate Name
CB DEKRA Certification B.V.	IEC 61984	NL-113351
KEMA/KEUR DEKRA Certification B.V.	EN 61984	71-130478 REV.1
UR Underwriters Laboratories Inc.	UL 1059	E45172



Approval	Standard	Certificate Name
BV Bureau Veritas S.A.	IEC 60998	11915/E0 BV

**Downloads**

**Environmental Product Compliance**

Compliance Search	
Environmental Product Compliance 723-602/114-000	<a href="#">↓</a>

**Documentation**

Additional Information			
Technical Section	03.04.2019	pdf 2027.26 KB	<a href="#">↓</a>

**CAD/CAE-Data**

CAD data	
2D/3D Models 723-602/114-000	<a href="#">↓</a>

CAE data	
ZUKEN Portal 723-602/114-000	<a href="#">↓</a>

**1 Compatible Products**

**1.1 System counterpart**

**1.1.1 Female connector/socket**



**Item No.: 721-202/026-000**  
 1-conductor female connector; CAGE CLAMP®; 2.5 mm²; Pin spacing 7.5 mm; 2-pole; 100% protected against mismatching; 2,50 mm²; light gray

1.2 Optional Accessories

1.2.1 Coding

1.2.1.1 Coding



**Item No.: 231-130**  
Coding key; snap-on type; light gray

1.2.2 Cover

1.2.2.1 Cover



**Item No.: 231-668**  
Lockout caps; for covering unused clamping units; gray

1.2.3 Ferrule

1.2.3.1 Ferrule



**Item No.: 216-301**  
Ferrule; Sleeve for 0.25 mm<sup>2</sup> / AWG 24; insulated; electro-tin plated; yellow



**Item No.: 216-302**  
Ferrule; Sleeve for 0.34 mm<sup>2</sup> / 22 AWG; insulated; electro-tin plated; light turquoise



**Item No.: 216-201**  
Ferrule; Sleeve for 0.5 mm<sup>2</sup> / 20 AWG; insulated; electro-tin plated; electrolytic copper; acc. to DIN 46228, Part 4/09.90; white



**Item No.: 216-241**  
Ferrule; Sleeve for 0.5 mm<sup>2</sup> / 20 AWG; insulated; electro-tin plated; electrolytic copper; gastight crimped; acc. to DIN 46228, Part 4/09.90; white



**Item No.: 216-141**  
Ferrule; Sleeve for 0.5 mm<sup>2</sup> / 20 AWG; un-insulated; electro-tin plated; electrolytic copper; gastight crimped; acc. to DIN 46228, Part 1/08.92



**Item No.: 216-101**  
Ferrule; Sleeve for 0.5 mm<sup>2</sup> / AWG 22; un-insulated; electro-tin plated; silver-colored



**Item No.: 216-242**  
Ferrule; Sleeve for 0.75 mm<sup>2</sup> / 18 AWG; insulated; electro-tin plated; electrolytic copper; gastight crimped; acc. to DIN 46228, Part 4/09.90; gray



**Item No.: 216-262**  
Ferrule; Sleeve for 0.75 mm<sup>2</sup> / 18 AWG; insulated; electro-tin plated; electrolytic copper; gastight crimped; acc. to DIN 46228, Part 4/09.90; gray



**Item No.: 216-202**  
Ferrule; Sleeve for 0.75 mm<sup>2</sup> / 18 AWG; un-insulated; electro-tin plated; gray



**Item No.: 216-142**  
Ferrule; Sleeve for 0.75 mm<sup>2</sup> / 18 AWG; un-insulated; electro-tin plated; electrolytic copper; gastight crimped; acc. to DIN 46228, Part 1/08.92



**Item No.: 216-102**  
Ferrule; Sleeve for 0.75 mm<sup>2</sup> / AWG 20; un-insulated; electro-tin plated; silver-colored



**Item No.: 216-243**  
Ferrule; Sleeve for 1 mm<sup>2</sup> / AWG 18; insulated; electro-tin plated; electrolytic copper; gastight crimped; acc. to DIN 46228, Part 4/09.90; red



**Item No.: 216-263**  
Ferrule; Sleeve for 1 mm<sup>2</sup> / AWG 18; insulated; electro-tin plated; electrolytic copper; gastight crimped; acc. to DIN 46228, Part 4/09.90; red



**Item No.: 216-203**  
Ferrule; Sleeve for 1 mm<sup>2</sup> / AWG 18; insulated; electro-tin plated; red



**Item No.: 216-103**  
Ferrule; Sleeve for 1 mm<sup>2</sup> / AWG 18; un-insulated; electro-tin plated



**Item No.: 216-143**  
Ferrule; Sleeve for 1 mm<sup>2</sup> / AWG 18; un-insulated; electro-tin plated; electrolytic copper; gastight crimped; acc. to DIN 46228, Part 1/08.92



**Item No.: 216-204**  
Ferrule; Sleeve for 1.5 mm<sup>2</sup> / AWG 16; insulated; electro-tin plated; black



**Item No.: 216-244**  
Ferrule; Sleeve for 1.5 mm<sup>2</sup> / AWG 16; insulated; electro-tin plated; electrolytic copper; gastight crimped; acc. to DIN 46228, Part 4/09.90; black



**Item No.: 216-264**  
Ferrule; Sleeve for 1.5 mm<sup>2</sup> / AWG 16; insulated; electro-tin plated; electrolytic copper; gastight crimped; acc. to DIN 46228, Part 4/09.90; black



**Item No.: 216-284**  
Ferrule; Sleeve for 1.5 mm<sup>2</sup> / AWG 16; insulated; electro-tin plated; electrolytic copper; gastight crimped; acc. to DIN 46228, Part 4/09.90; black



**Item No.: 216-144**  
Ferrule; Sleeve for 1.5 mm<sup>2</sup> / AWG 16; un-insulated; electro-tin plated; electrolytic copper; gastight crimped; acc. to DIN 46228, Part 1/08.92; silver-colored



**Item No.: 216-104**  
Ferrule; Sleeve for 1.5 mm<sup>2</sup> / AWG 16; un-insulated; electro-tin plated; silver-colored



**Item No.: 216-106**  
Ferrule; Sleeve for 2.5 mm<sup>2</sup> / AWG 14; un-insulated; electro-tin plated; silver-colored

## 1.2.4 Insulation stop

### 1.2.4.1 Insulation stop



**Item No.: 231-673**

Insulation stop; 0.08-0.2 mm<sup>2</sup> / 0.2 mm<sup>2</sup> "s"; white



**Item No.: 231-674**

Insulation stop; 0.25 - 0.5 mm<sup>2</sup>; light gray



**Item No.: 231-675**

Insulation stop; 0.75 - 1 mm<sup>2</sup>; dark gray

## 1.2.5 Marking

### 1.2.5.1 Marking strip



**Item No.: 210-833**

Marking strips; 25 m on roll; 6 mm wide; plain; Self-adhesive; white



**Item No.: 210-834**

Marking strips; on reel; 5 mm wide; plain; Self-adhesive; white

## 1.2.6 Strain relief

### 1.2.6.1 Strain relief housing



**Item No.: 232-662**

Strain relief housing; for female and male connectors; 2 parts; Pin spacing 7.5 mm; 2-pole; gray

## 1.2.7 Tool

### 1.2.7.1 Operating tool



**Item No.: 231-231**

Combination operating tool; red



**Item No.: 231-291**

Operating tool; made of insulating material; 1-way; loose; red



**Item No.: 231-131**

Operating tool; made of insulating material; 1-way; loose; white



**Item No.: 231-159**

Operating tool; natural

## Installation Notes

### Conductor termination

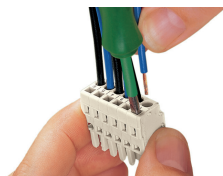

Inserting a conductor via 3.5 mm screwdriver – CAGE CLAMP® actuation parallel to conductor entry.

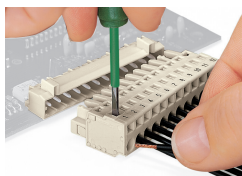

Inserting a conductor via 3.5 mm screwdriver – CAGE CLAMP® actuation perpendicular to conductor entry.

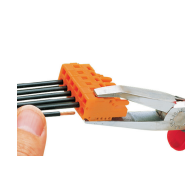
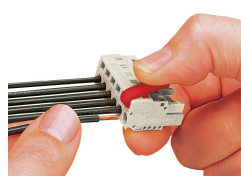

Inserting a conductor via operating tool.

## Testing

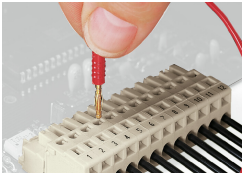

Testing perpendicular to conductor entry with 2 or 2.3 mm Ø test plug – female connector with CAGE CLAMP® – via integrated test ports

## Installation



Male connector with strain relief plate



Strain relief housing shown with a male connector equipped with CAGE CLAMP®

## Coding

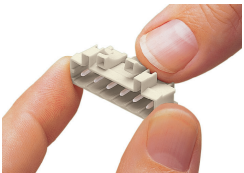

Coding a male header – fitting coding key (s).