

# D-Code

# # DC 4666

## Instrucțiuni de montare

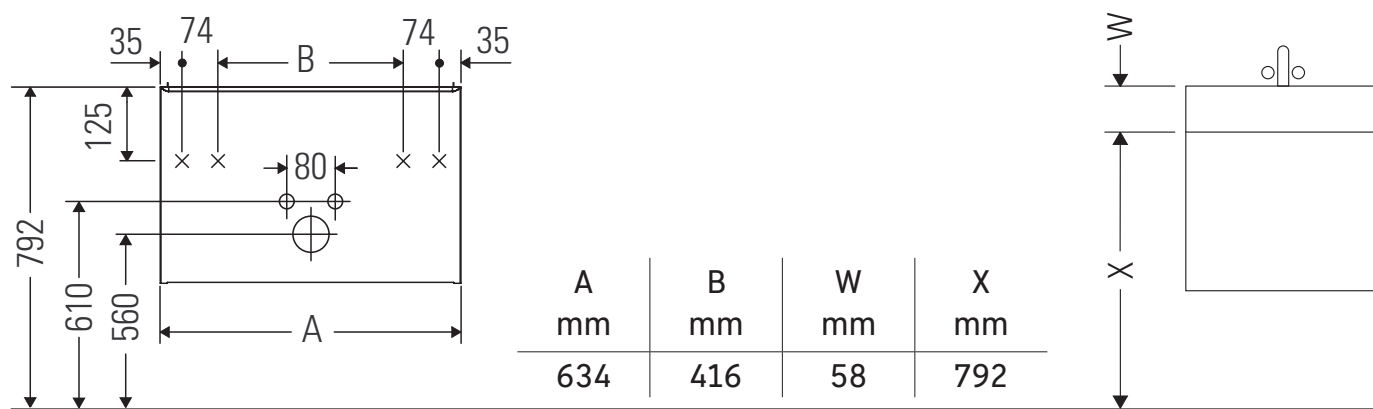

D-Code # 239965

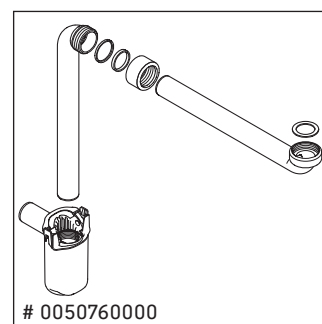
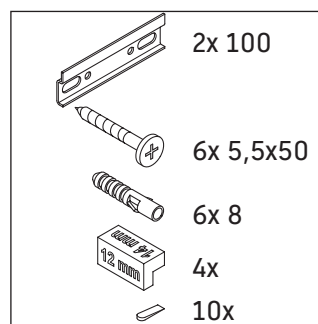
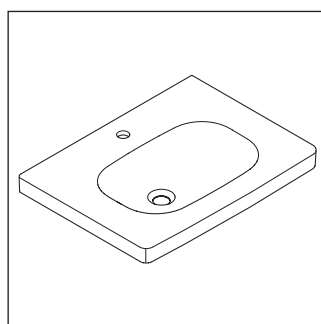
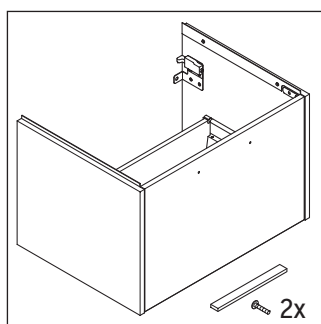

### Indicații de utilizare

Seria de mobilier de baie corespunde normelor și directivelor valabile în momentul livrării și este concepută pentru utilizarea în băi. Trebuie evitată stropirea directă cu apă, de ex. în timpul dușului.

Ne rezervăm dreptul de a efectua îmbunătățiri tehnice și modificări optice la produsele din poze.



