

# D-Code

# # DC 4668

## 설치 설명서

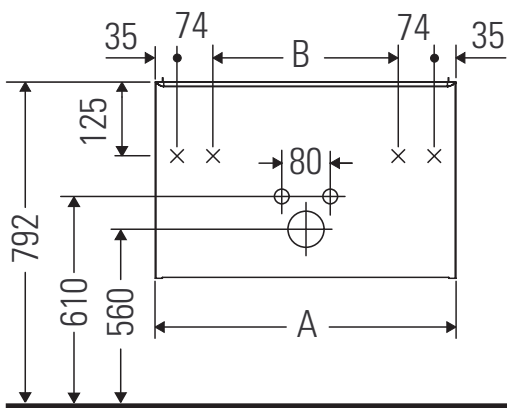

A mm	B mm	W mm	X mm
984	766	58	792

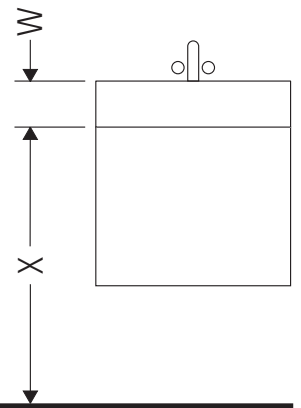

**D-Code # 239910**

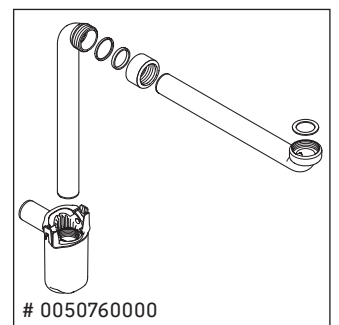
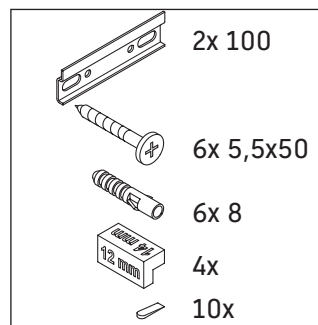
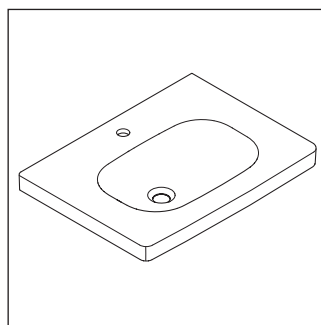
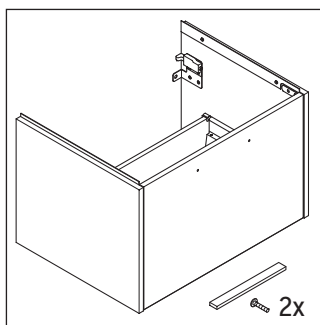

### 사용 지침

본 욕실 가구 시리즈는 배송 시의 해당 표준 및 지침을 준수하며 욕실 설치용으로 제조되었습니다. 물과의 직접 접촉(예: 샤워 시)을 피하십시오.

사진에 제시된 제품에 기술적인 개선 및 디자인 변경이 있을 수 있습니다.



