

ARGUS Presence Slave

Operating instructions

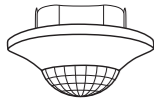

Art. no. MTN5570-1019

Accessories

- Surface-mounted housing for ARGUS Presence (Art. no. MTN550619)
- PlusLink Expander (Art. no. CCTDT5130)

For your safety

DANGER

Risk of serious damage to property and personal injury, e.g. from fire or electric shock, due to incorrect electrical installation.

Safe electrical installation can only be ensured if the person in question can prove basic knowledge in the following areas:

- Connecting to installation networks
- Connecting several electrical devices
- Laying electric cables

These skills and experience are normally only possessed by skilled professionals who are trained in the field of electrical installation technology. If these minimum requirements are not met or are disregarded in any way, you will be solely liable for any damage to property or personal injury.

DANGER

Risk of death from electric shock.

The PlusLink carries an electrical current even when the device is switched off. Before working on the device, always disconnect it from the supply by means of the fuse in the incoming circuit. If one or more PlusLink lines are separately fused in your installation then they are not electrically isolated from one another. In this case, you should use the PlusLink Expander.

CAUTION

The device can become damaged.

The voltage differential between different phases can damage the device. All devices connected to one or more PlusLink lines must be connected to the same phase.

Getting to know ARGUS Presence Slave

The ARGUS Presence Slave (referred to below as **ARGUS**) is a presence detector for interior ceiling mounting. The ARGUS comprises a sensor module and a central unit insert (referred to below as **insert**). The ARGUS can be mounted either in a flush-mounted socket or in surface-mounted housing (available as an accessory). It detects moving heat sources (e.g. people) within an adjustable area of detection and sends a trigger command to the PlusLink (PL).

The maximum detection radius is approx. 7 m. The angle of detection is 360°. As long as a movement is detected, the ARGUS sends trigger commands to the PlusLink (trigger function).

The specified detection radius refers to average conditions and a recommended mounting height of approx. 2.50 m and should therefore be taken as guide values. The range can vary greatly when the temperature fluctuates.

The insert makes it possible to switch a global staircase lighting function by sending a trigger command.

- Central unit insert **Sensor module:** staircase lighting function **independent** of brightness and sending of a trigger command

Using the insert, you can control all receiving devices in up to four **PlusLink** lines.

Receiving devices include, for example, the following devices:

- ARGUS Presence master with IR, relay 1-gang/2-gang
- ARGUS Presence master with IR, DALI
- ARGUS Presence master with IR, 1-10 V

The insert has four PlusLink outputs for connecting to the PlusLink lines. To be able to use the **PlusLink (PL)**, you require a separate core in your installation for each PlusLink line.

CAUTION

The insert can become damaged.

- Always operate the insert in compliance with the specified technical data.

Understanding PlusLink

What you need to know about the PlusLink:

- To be able to use the PL, you require a separate core per PL line in your installation.

Recommended cables for PL installation	Maximum total cable sections in a PL line
NYM-J 3x1.5 mm ²	100 m
NYM-J 4x1.5 mm ²	80 m
NYM-J 5x1.5 mm ²	65 m

- All devices connected to one or more PL lines must be connected to the same phase.
- The PL carries mains voltage.
- The PL transfers the commands from the sending devices to the receiving devices. Individual addressing of the devices in the PL line is not possible. All devices are always activated at the same time.
- A maximum of 10 sending and 10 receiving devices can be connected to a PL line.
- The PL is not subject to prioritisation. Each new command overwrites the previous one.
- No separate software is required for using the PL.

Using the sensor module with alarm systems

Movement/presence detectors are not suitable for use as components of an alarm system.

Movement/presence detectors can trigger false alarms if the installation site is unsuitable.

Movement/presence detectors switch on as soon as they detect a moving heat source. This can be a person, but also animals or differences in temperature through windows. In order to avoid false alarms, the chosen installation site should be such that undesired heat sources cannot be detected (see section „Selecting the installation site“).

Connections, displays and operating elements

Front:

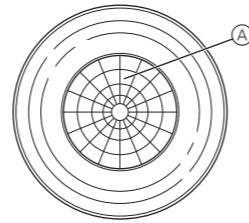

(A) red LED (in test mode)

Rear:

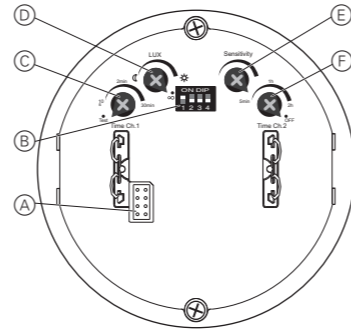

- (A) Module interface
- (B) DIP switch (no function)
- (C) Test mode
- (D) no function
- (E) Potentiometer for sensitivity
- (F) no function

Selecting the installation site

- Only mount the sensor module in positions that allow the desired area to be monitored effectively.

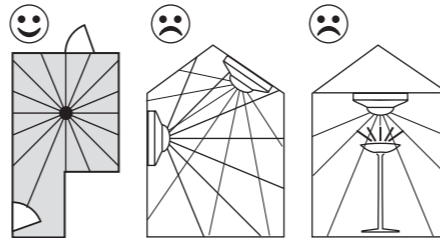

- Install the sensor module on the ceiling, if at all possible in the centre of the room.
- Do not install the sensor module on inclines or walls.
- Install the sensor module at least 0.5 m away from lights.
- The recommended mounting height is 2.50 m. Any mounting height which deviates from this will affect the area of detection.
- Maximum area of detection of the sensor module: 360° angle of detection, approx. 7 m detection radius.

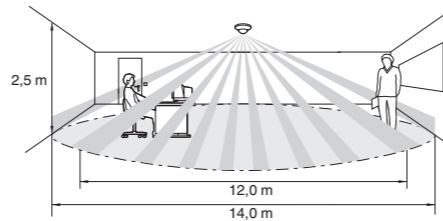

- Inner/outer area of detection
 - inner area of detection (approx. 6 m radius): movement detection of a seated person due to less movement
 - outer area of detection (approx. 7 m radius): movement detection of a person walking due to increased movement

- In order to ensure continuous monitoring, e.g. of a long hall, the areas of detection of the individual sensor modules have to intersect.

- Movement/presence detectors detect objects that radiate heat. You should select an installation site that will not result in undesired heat sources being detected, such as:
 - switched-on lamps in the area of detection
 - open fires (such as in fireplaces)
 - moving curtains, etc., that cause a different temperature in their surrounding environment due to strong sunlight
 - windows where the influence of alternating sunlight and clouds could cause rapid changes in temperature
 - larger heat sources (e.g. cars), that are detected through windows
 - sunlit rooms with reflecting objects (e.g. the floor), which can be the cause of rapid changes in temperature
 - windowpanes heated up by sunlight
 - dogs, cats, etc.
- To prevent faulty operation, the insert should be installed in a wind-resistant flush-mounted socket. With flush-mounted sockets and pipe cabling systems, a draught of air at the rear of the equipment can trigger the sensor module.
- Avoid direct sunlight. This can destroy the sensor in extreme cases.

Installation location for master/slave operation

- In order to ensure the room is as well-lit as possible, put the master in the darkest area of the area used. This means the lighting will still turn on when there is already sufficient ambient brightness in some areas.
- When operating with several master devices in one room (multi master), the individual lighting areas have common borders. This poses the risk that these affect each other (optical feedback). Try to avoid multi-master operation. If this is not possible, place the master in an area that is at the maximum possible distance from the bordering lighting areas.

ARGUS installation

Wiring the insert for the application required

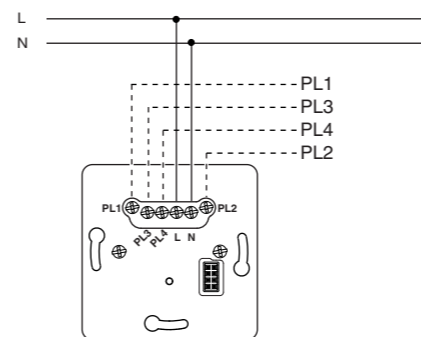

Installing ARGUS

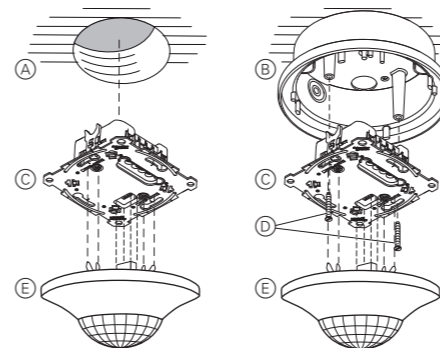

- (A) Flush-mounted socket
- (B) Surface-mounted housing for ARGUS Presence (accessory)
- (C) Insert
- (D) Screws (included with surface-mounted housing)
- (E) Sensor module

Setting the sensor module

On the rear side of the sensor module, the potentiometer can be used to set the sensor module's sensitivity.

The DIP switches and potentiometer for the brightness threshold and switching duration do not function on the central unit insert.

Setting the sensitivity

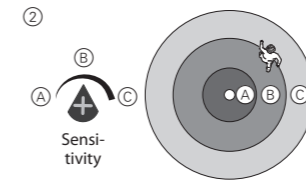
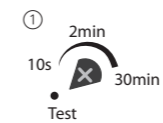

- 1 Activate test mode. The red LED lights up when movement is detected.
- 2 Infinitely adjust the sensitivity (max. 7 m detection radius).
- 3 Walk around the area of detection and check whether the red LED lights up. Adjust the sensitivity if required.

Operating the sensor module: global staircase lighting function via PlusLink

Example of global control via ARGUS Presence slave

If the ARGUS (A) detects a movement, it sends a trigger command to all local sensor modules (B) in the PL lines. In this example the local sensor module (B) checks the brightness of the surroundings. The staircase lighting function only starts if the brightness is below the set detection brightness.

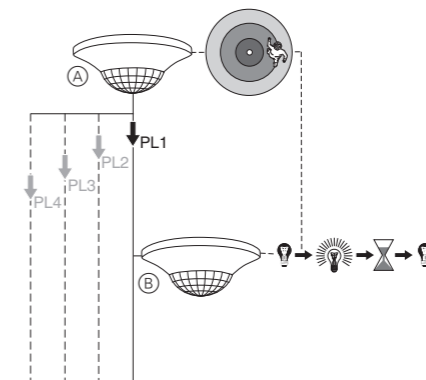

- (A) ARGUS Presence slave
- (B) ARGUS Presence master in PL line 1

- Notes:
- The ARGUS Presence slave always sends independently of brightness.
 - The DIP switches of the ARGUS Presence slave have no function.

Example of two ARGUS Presence slaves in the PL line

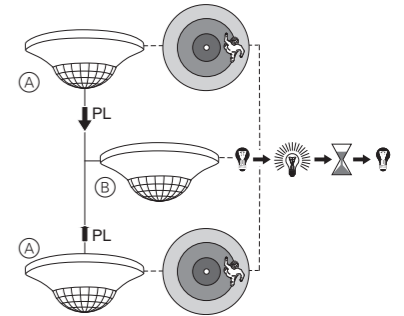

- (A) ARGUS Presence slave
- (B) ARGUS Presence master in PL line

Technical data

Insert

Nominal voltage:	AC 220/230 V ~, 50/60 Hz
Neutral conductor:	required
Output:	4 x PlusLink
Connecting terminals:	Screw terminals for max. 2x 2.5 mm ² or 2x 1.5 mm ²
Protection:	max. 16 A circuit breaker

Sensor module

Angle of detection:	360°
Number of levels:	6
Number of zones:	136
Number of movement sensors:	4
Recommended mounting height:	2.50 m
Range (can be adjusted under "Sensitivity"):	max. approx. 7 m detection radius
Detection brightness:	independent of brightness
Display elements:	1 red LED
DIP switch:	no function
Connection:	module interface with 8 contact pins

Schneider Electric Industries SAS

If you have technical questions, please contact the Customer Care Centre in your country.
www.schneider-electric.com

