

D-Code

DC 4670

Ръководство за монтаж

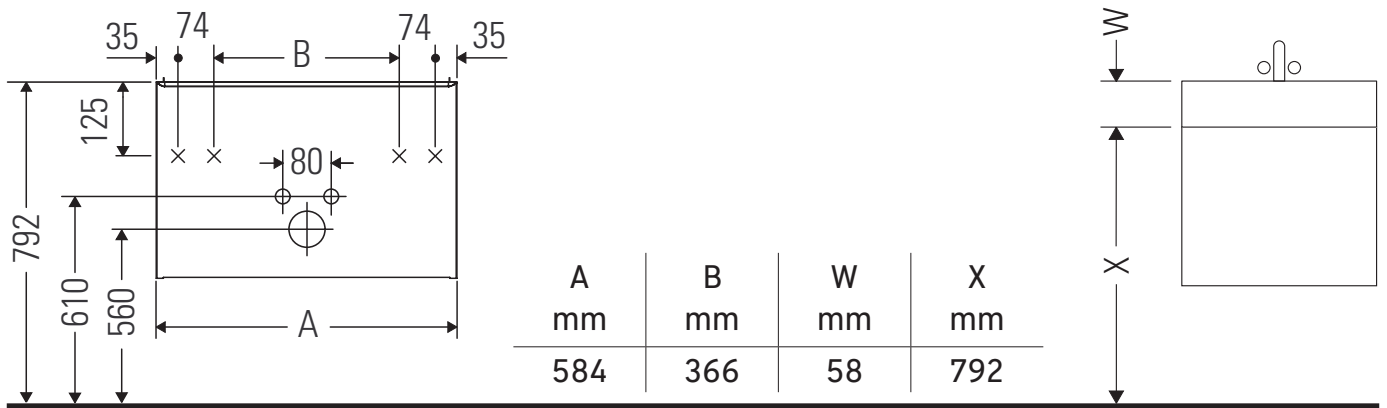

D-Code # 239960

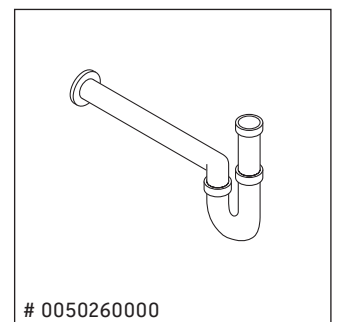
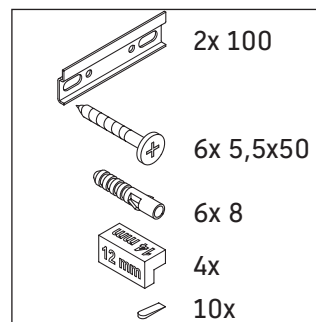
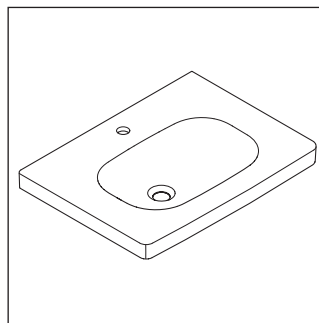
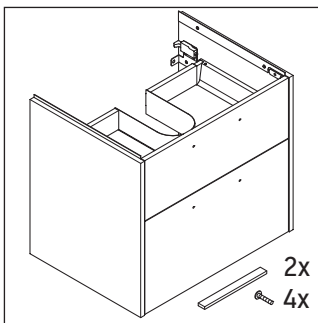

Указания за употреба

Серията мебели за баня отговаря на действащите стандарти и директиви към момента на доставката и е създадена за използване в бани. Да се избягва директно пръскане с вода, напр. при използването на душа.

Запазваме си правото за технически подобрения и оптични промени на изобразените изделия.

