

D-Code

DC 4670

Paigaldusjuhend

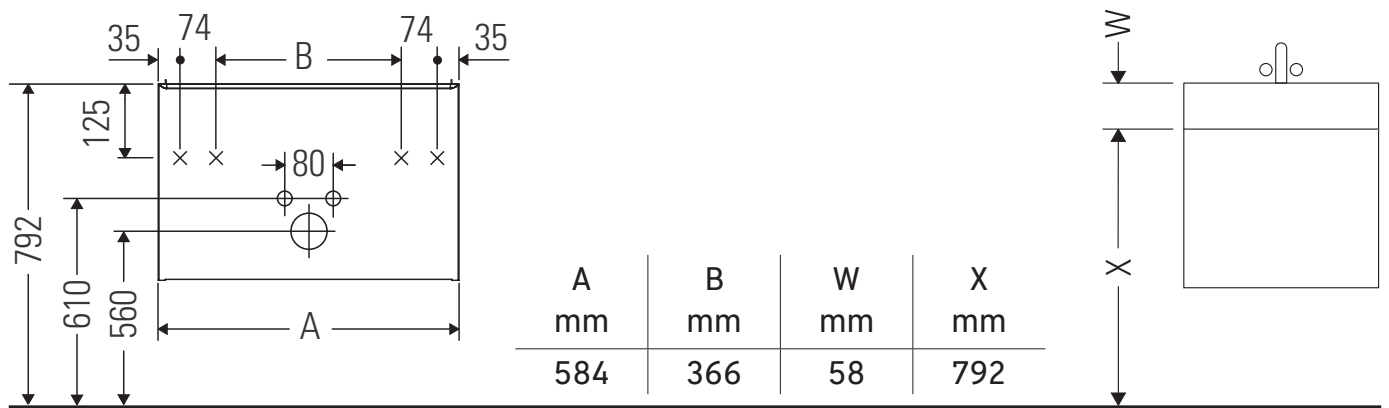

D-Code # 239960

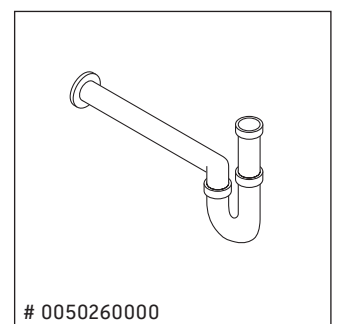
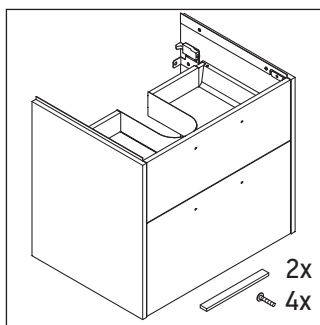

Kasutusjuhised

Vannitoamööbel vastab kehtivatele normidele ja direktiividele mööbli tarnimise ajahetkel ja mööbel on mõeldud kasutamiseks vannitubades. Vältige mööbli otsest kokkupuudet veega.

Me jätame endale esitatud toodetel tehniliste täiustuste ja optiliste muudatuste tegemise õiguse.



