

D-Code

DC 4670

설치 설명서

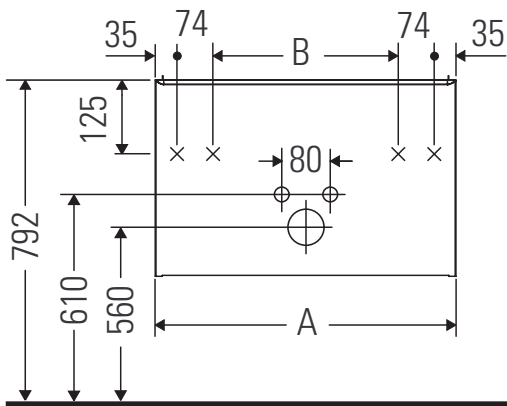

A mm	B mm	W mm	X mm
584	366	58	792

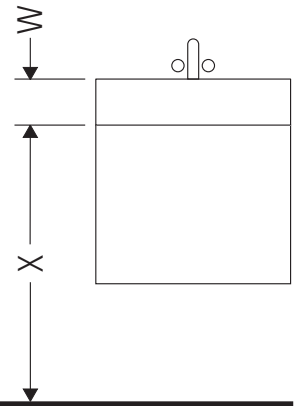

D-Code # 239960

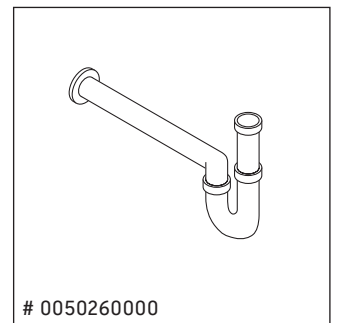
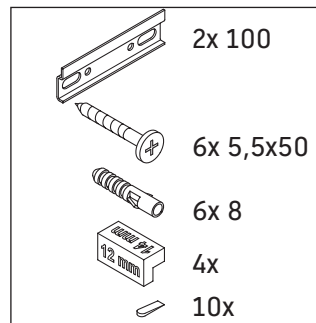
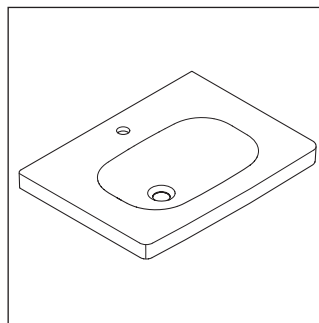
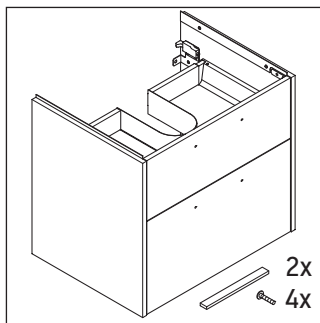

사용 지침

본 욕실 가구 시리즈는 배송 시의 해당 표준 및 지침을 준수하며 욕실 설치용으로 제조되었습니다. 물과의 직접 접촉(예: 샤워 시)을 피하십시오.

사진에 제시된 제품에 기술적인 개선 및 디자인 변경이 있을 수 있습니다.



