

Phase inverter AM-TOP

Part number: 338



MENNEKES
Elektrotechnik GmbH & Co. KG

Aloys-Mennekes-Straße 1
57399 Kirchhundem
GERMANY

www.MENNEKES.org

Product Description

- screw connection technology
- single part body
- protection against kinking
- strain relief
- cable gland and sealing

Technical Details

Plug AM-TOP	338
Product serie	AM-TOP
Ampere	16A
Number of poles	4p
Clock position	9h
Nominal voltage AC	230V
Nominal frequency	50 - 60 Hz
Protection type IP	IP44
Contact carrier	standard
Connection	screw terminals
Contact screw drive	PZ2, slot
Tightening torque connection terminal for cable cross-section 1,0 - 1,5 mm ²	0.6 Nm
Tightening torque connection terminal for cable cross-section 2,5 - 4,0 mm ²	0.8 Nm
Recommended wire end treatment for supply cable connection terminal	ferrule square gasproof crimped
Strip length jacket	40 mm
Strip length conductor	8 - 10 mm
Phase inverter	with phase inverter
Pilot contact	without pilot contact
Conductor cross-section min.	1 mm ²
Conductor cross-section max.	2.5 mm ²
Cable kink protection	integrated in cable gland
Protective grommet	without protective grommet
Protective cap	without protective cap
Weight (net)	155 g

Plug AM-TOP	338
Packaging unit	10 pcs
EAN / identification number	4015394194101

Permissible ambient conditions		
	Min.	Max.
Permanent ambient temperature	-25 °C	40 °C

Material properties	
Housing	PA6 blue [similar RAL 5007]
Clamp basket	PA6 natural colour [no RAL colour code]
	TPE squirrel grey [similar RAL 7000]
Fastening	PA6 squirrel grey [similar RAL 7000]

Material resistance

The material resistance overview can be found on the website in the section “Knowledge” - “Product knowledge” - “Materials”.

Material and enviromental properties	
RoHS 2011/65/EU incl. 2015/863/EU	✓
POP regulation (EU) 2019/1021	✓

Regulations and Standards	
Norm	DIN EN IEC 60309-2
Declaration of Conformity	CE
Test label	EAC, CQC

Dimensional Drawing

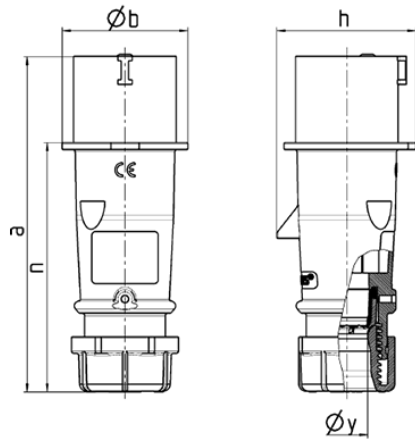

Drawing 2 MB 217	Amp. Poles	16			32		
		3	4	5	3	4	5
Dim. in mm	a	142	147	147	186	186	180
	b	53	59	67	70	70	77
	h	59	69.4	76	81	81	89.5
	n	105.2	110.5	110.5	141	141	135
	y	14.5	16	16	22	22	22
Terminal for cond. cross		1	1	1	2.5	2.5	2.5
section (mm ²) min.-max.		—2.5	—2.5	—2.5	—6	—6	—6