













Slide unit for spray sets Ø 18 mm - Brushed Dark Brass (PVD)

SPARE PARTS

90 30 12 500 02 Product version from 4/1/2025



	Brushed Dark Brass (PVD)	90 30 12 500 02-39
	Chrome	90 30 12 500 02-00
	brushed chrome	90 30 12 500 02-04
	Brushed Platinum	90 30 12 500 02-06
	Platinum	90 30 12 500 02-08
	Durabronze (23kt Gold)	90 30 12 500 02-09
	Matte White	90 30 12 500 02-10
	Brushed Light Gold (PVD)	90 30 12 500 02-27
	Matte Black	90 30 12 500 02-33
	Brushed Bronze (PVD)	90 30 12 500 02-42
	Champagne (22kt Gold)	90 30 12 500 02-47
	Brushed Dark Platinum	90 30 12 500 02-99



Slide unit for spray sets Ø 18 mm - Brushed Dark Brass (PVD)

SPARE PARTS

90 30 12 500 02 Product version from 4/1/2025



Slide unit for spray sets Ø 18 mm - Brushed Dark Brass (PVD)

SPARE PARTS

90 30 12 500 02 Product version from 4/1/2025

90 30 12 500 02 Product version from 4/1/2025

Parts for other finishes can be found here: [Chrome](#)

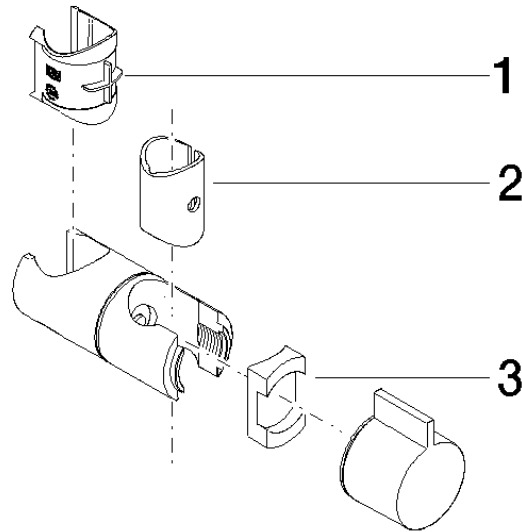

Spare parts list

No.	Item Number	Name	Quantity used	Delivery time
3	08 18 40 514 90	Insert for shower set 20 x 30 x 10 mm -	1.00	14
1	09 12 12 212 90	Receptacle for hand shower 25,08 x 33 x 26,04 mm -	1.00	14
2	08 18 40 515 90	Sleeve 20 x 35 x 20 mm -	1.00	14