

## Data Sheet | Item Number: 261-209

4-conductor terminal strip; without push-buttons; with fixing flanges; 9-pole; for screw or similar mounting types; Fixing hole 3.2 mm Ø; 2.5 mm<sup>2</sup>; CAGE CLAMP®; gray

<https://www.wago.com/261-209>

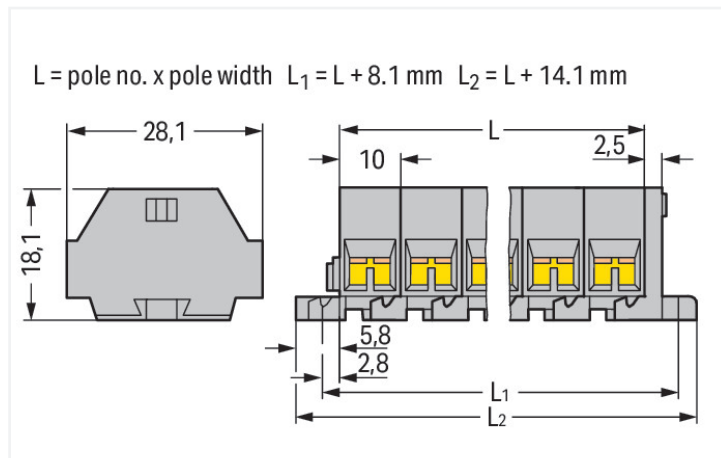
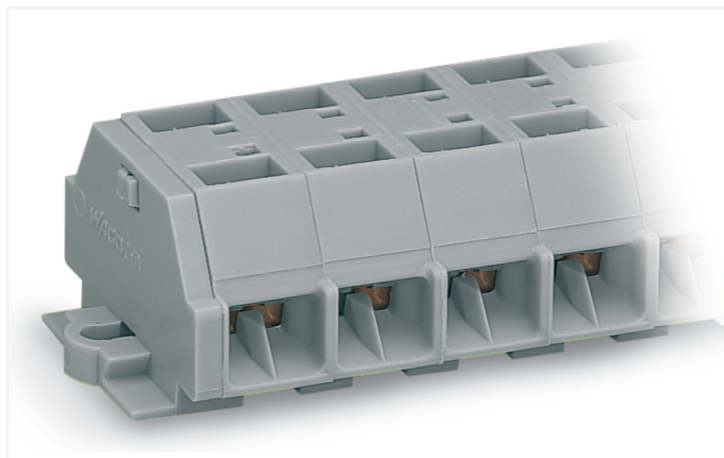

Color: ■ gray

Similar to illustration

Dimensions in mm

Through terminal block, 261 Series, CAGE CLAMP®

Our through terminal block (item number 261-209) ensures effortless electrical installations. Conductors can only be connected to this through terminal block if their strip length is between 8 and 9 mm. Our mini rail-mount terminal blocks are perfect for working in small spaces thanks to their compact design. With various mounting and actuation options, they offer maximum flexibility. This product features conductor terminals and utilizes CAGE CLAMP®. Our CAGE CLAMP® connection provides a secure and maintenance-free way to connect all types of conductors. You do not need to prepare the conductor in any way, such as crimping ferrules. The dimensions are (104.1 x 28.1 x 18.1) mm (width x height x depth). This through terminal block is suitable for conductor cross sections ranging from 0.08 mm<sup>2</sup> to 2.5 mm<sup>2</sup>.

This mini rail-mount terminal block is operated with an operating tool.

### Electrical data

#### Ratings per IEC/EN

Nominal voltage (III/3)	500 V
Rated impulse withstand voltage (III / 3)	6 kV
Rated current	24 A
Legend (ratings)	(III / 3) ≙ Overvoltage category III / Pollution degree 3

#### Approvals per

#### UL 1059

Use group	B	C	D
Rated voltage	300 V	300 V	600 V
Rated current	15 A	15 A	5 A

#### Approvals per

#### CSA 22.2 No 158

Use group	B	C	D
Rated voltage	-	300 V	600 V
Rated current	-	10 A	5 A

#### General information

Wiring direction	Side-entry wiring
------------------	-------------------

## Connection Data

Clamping units	36
Total number of potentials	9
Number of levels	1

### Connection 1

Connection technology	CAGE CLAMP®
Actuation type	Operating tool
Connectable conductor materials	Copper
Solid conductor	0.08 ... 2.5 mm <sup>2</sup> / 28 ... 14 AWG
Fine-stranded conductor	0.08 ... 2.5 mm <sup>2</sup> / 28 ... 14 AWG
Strip length	8 ... 9 mm / 0.31 ... 0.35 inches
Pole number	9
Wiring direction	Side-entry wiring

## Physical data

Width	104.1 mm / 4.098 inches
Height	28.1 mm / 1.106 inches
Depth	18.1 mm / 0.713 inches
Module width	10 mm / 0.394 inches

## Mechanical data

Design	horizontal type
Mounting type	Mounting flange
Marking level	Side marking

## Material data

Note (material data)	<a href="#">Information on material specifications can be found here</a>
Color	gray
Material group	I
Insulation material (main housing)	Polyamide (PA66)
Flammability class per UL94	V0
Fire load	0.564 MJ
Halogen-free	Yes
Weight	35.9 g

## Commercial data

PU (SPU)	25 pcs
Packaging type	Box
Country of origin	DE
GTIN	4044918612302
Customs tariff number	85369010000

## Product Classification

UNSPSC	39121410
eCl@ss 10.0	27-14-11-06
eCl@ss 9.0	27-14-11-06
ETIM 9.0	EC001284
ETIM 10.0	EC001284
ECCN	NO US CLASSIFICATION

## Environmental Product Compliance

RoHS Compliance Status

Compliant, No Exemption

## Approvals / Certificates

### General approvals



Approval	Standard	Certificate Name
CCA DEKRA Certification B.V.	EN 60998	NTR-NL 6509
KEMA/KEUR DEKRA Certification B.V.	EN 60998	2110272.02
UR Underwriters Laboratories Inc.	UL 1059	E45172

### Declarations of conformity and manufacturer's declarations

Approval	Standard	Certificate Name
EU-Declaration of Conformity WAGO GmbH & Co. KG	-	-
UK-Declaration of Conformity WAGO GmbH & Co. KG	-	-

### Approvals for marine applications



Approval	Standard	Certificate Name
ABS American Bureau of Shipping	-	24-0095979-PDA
BV Bureau Veritas S.A.	EN 60947	07436/G0 BV
DNV DNV GL SE	-	TAE00001V2
LR Lloyds Register	IEC 60998	LR22173030TA
PRS Polski Rejestr Statków	-	TE/1094/880590/23

## Downloads

### Environmental Product Compliance

#### Compliance Search

 Environmental Product  
Compliance 261-209
 

## Documentation

### Bid Text

261-209	19.02.2019	xml 3.11 KB	
261-209	14.06.2017	doc 25.00 KB	

CAD/CAE-Data

CAD data

2D/3D Models 261-209



CAE data

EPLAN Data Portal  
261-209



WSCAD Universe  
261-209



ZUKEN Portal 261-209



1 Compatible Products

1.1 Optional Accessories

1.1.1 Ferrule

1.1.1.1 Ferrule



[Item No.: 216-301](#)

Ferrule; Sleeve for 0.25 mm<sup>2</sup> / AWG 24; insulated; electro-tin plated; yellow



[Item No.: 216-302](#)

Ferrule; Sleeve for 0.34 mm<sup>2</sup> / 22 AWG; insulated; electro-tin plated; light turquoise



[Item No.: 216-201](#)

Ferrule; Sleeve for 0.5 mm<sup>2</sup> / 20 AWG; insulated; electro-tin plated; electrolytic copper; acc. to DIN 46228, Part 4/09.90; white



[Item No.: 216-101](#)

Ferrule; Sleeve for 0.5 mm<sup>2</sup> / AWG 22; un-insulated; electro-tin plated; silver-colored



[Item No.: 216-202](#)

Ferrule; Sleeve for 0.75 mm<sup>2</sup> / 18 AWG; insulated; electro-tin plated; gray



[Item No.: 216-102](#)

Ferrule; Sleeve for 0.75 mm<sup>2</sup> / AWG 20; un-insulated; electro-tin plated; silver-colored



[Item No.: 216-203](#)

Ferrule; Sleeve for 1 mm<sup>2</sup> / AWG 18; insulated; electro-tin plated; red



[Item No.: 216-103](#)

Ferrule; Sleeve for 1 mm<sup>2</sup> / AWG 18; un-insulated; electro-tin plated



[Item No.: 216-204](#)

Ferrule; Sleeve for 1.5 mm<sup>2</sup> / AWG 16; insulated; electro-tin plated; black



[Item No.: 216-104](#)

Ferrule; Sleeve for 1.5 mm<sup>2</sup> / AWG 16; un-insulated; electro-tin plated; silver-colored



[Item No.: 216-205](#)

Ferrule; Sleeve for 2.08 mm<sup>2</sup> / AWG 14; insulated; electro-tin plated; yellow



[Item No.: 216-206](#)

Ferrule; Sleeve for 2.5 mm<sup>2</sup> / AWG 14; insulated; electro-tin plated; blue



[Item No.: 216-106](#)

Ferrule; Sleeve for 2.5 mm<sup>2</sup> / AWG 14; un-insulated; electro-tin plated; silver-colored

1.1.2 Installation

1.1.2.1 Mounting accessories



[Item No.: 209-137](#)

Mounting adapter; can be used as end stop; 6.5 mm wide; gray



[Item No.: 209-123](#)

Mounting foot with screw; can be screwed on terminal blocks with fixing flange; 6.4 mm wide; gray

### 1.1.3 Jumper

#### 1.1.3.1 Jumper



**Item No.: 261-402**

Jumper; for conductor entry; 2-way; insulated; gray

### 1.1.4 Marking

#### 1.1.4.1 Marking strip



**Item No.: 210-833**

Marking strips; 25 m on roll; 6 mm wide; plain; Self-adhesive; white

### 1.1.5 Test and measurement

#### 1.1.5.1 Testing accessories



**Item No.: 261-405**

Test plug module; with locking latches; modular; for 4-conductor terminal blocks; for 261 Series; gray



**Item No.: 249-139**

Test plug module; without locking device; modular; for 4-conductor terminal blocks; gray

### 1.1.6 Tool

#### 1.1.6.1 Operating tool



**Item No.: 210-658**

Operating tool; Blade: 3.5 x 0.5 mm; with a partially insulated shaft; angled; short; multicoloured



**Item No.: 210-720**

Operating tool; Blade: 3.5 x 0.5 mm; with a partially insulated shaft; multicoloured



**Item No.: 210-657**

Operating tool; Blade: 3.5 x 0.5 mm; with a partially insulated shaft; short; multicoloured

### Installation Notes

#### Conductor termination

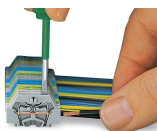

**CAGE CLAMP® connection**

Inserting a conductor.

With ferruled conductors, it is necessary to use a terminal block one size larger than the conductor's nominal cross-section.

## Commoning

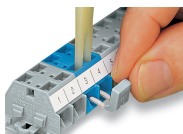

Commoning with comb-style jumper bar.

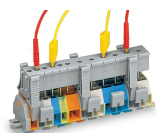

Testing via test plug modules snapped onto a terminal strip – wired or unwired. As touch contact is made with the CAGE CLAMP® (spring steel) unit, this testing type is limited to maximum 0.5 A.

Distance between locking devices must be approximately 35 ... 40 mm!



Testing after the conductors have been terminated.

## Installation

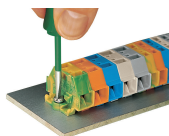

Mounting and securing a terminal strip directly to the plate via screw-type flanges.

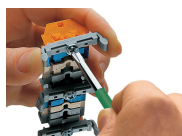

Terminal strip with mounting flanges  
Screwing a mounting foot (209-123).  
(Distance between mounting feet: approx. 25 ... 30 mm)

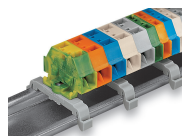

Terminal strip; with mounting flanges; for DIN-35 rail



Terminal strip with mounting flanges, for screw or similar mounting types, 3.2 mm mounting hole diameter (with 209-123 Mounting Foot also for DIN-35 rail)

## Marking



Marking with self-adhesive marking strips.



Marking by direct printing (upon request).