

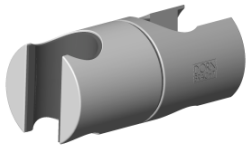











Slide unit for spray sets (2nd generation) Ø 23,5 x 1,3 mm - Platinum

SPARE PARTS

90 30 12 530 03



	Platinum	90 30 12 530 03-08
	Chrome	90 30 12 530 03-00
	Brushed Platinum	90 30 12 530 03-06
	Matte White	90 30 12 530 03-10
	Dark Chrome	90 30 12 530 03-19
	Light Gold (PVD)	90 30 12 530 03-26
	Brushed Light Gold (PVD)	90 30 12 530 03-27
	Brushed Durabrass (23kt Gold)	90 30 12 530 03-28
	Matte Black	90 30 12 530 03-33
	Brushed Bronze (PVD)	90 30 12 530 03-42
	Brushed Champagne (22kt Gold)	90 30 12 530 03-46
	Champagne (22kt Gold)	90 30 12 530 03-47
	Brushed Chrome	90 30 12 530 03-93
	Brushed Dark Platinum	90 30 12 530 03-99



Slide unit for spray sets (2nd generation) Ø 23,5 x 1,3 mm - Platinum

SPARE PARTS

90 30 12 530 03



Slide unit for spray sets (2nd generation) Ø 23,5 x 1,3 mm - Platinum

SPARE PARTS

90 30 12 530 03

90 30 12 530 03

Parts for other finishes can be found here: [Chrome](#)

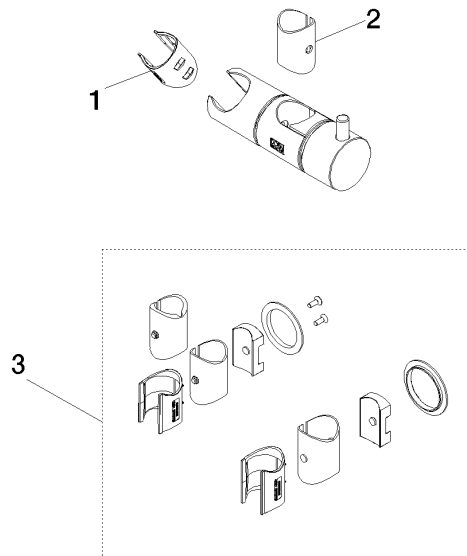

Spare parts list

No.	Item Number	Name	Quantity used	Delivery time
1	90 12 12 237 00 90	Receptacle for hand shower -	1.00	14
2	90 18 40 560 00 90	Insert Guide sleeve slider Ø 23,5 x 1,3 mm -	1.00	14
3	90 30 12 530 00 90	set	1.00	20