

## Data Sheet | Item Number: 721-605/114-040

1-conductor male connector; CAGE CLAMP®; 2.5 mm<sup>2</sup>; Pin spacing 5 mm; 5-pole;  
Preceding contact; 100% protected against mismatching; Snap-in flange; 2,50 mm<sup>2</sup>;  
light gray

<https://www.wago.com/721-605/114-040>



Color: ■ light gray

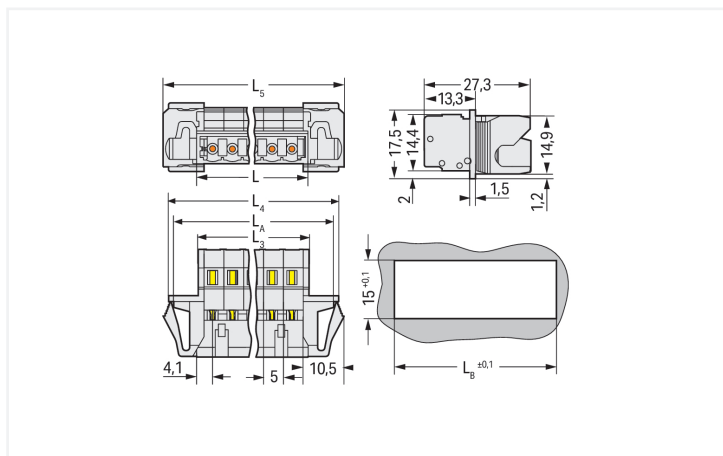
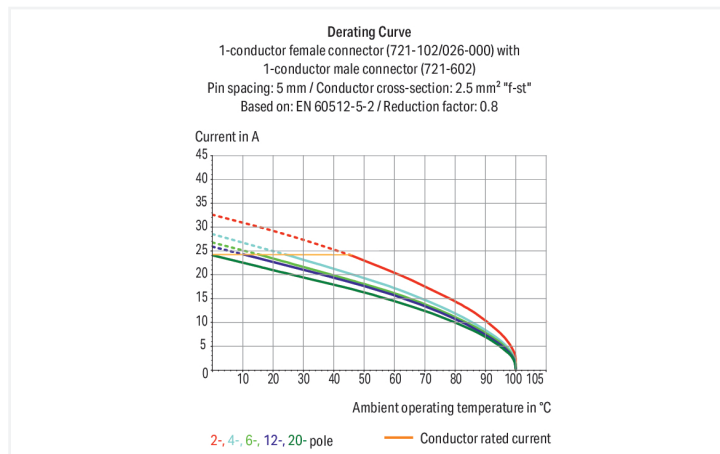

Dimensions in mm

$L = (\text{pole no.} \times \text{pin spacing}) + 3.2 \text{ mm}$   
 $L_3 = L - 0.2 \text{ mm}$   
 $L_4 = L_3 + 15.2 \text{ mm}$   
 $L_5 = L_3 + 18 \text{ mm}$   
 $L_A = L_3 + 12.6 \text{ mm}$   
 $L_B = L_3 + 13.2 \text{ mm}$

Male connector, 721 Series, CAGE CLAMP®

Our male connector (item number 721-605/114-040) ensures effortless electrical installations. Strip lengths must be between 8 and 9 mm when connecting conductors to this male connector. Featuring one conductor terminal along with CAGE CLAMP®, this connector is highly versatile. Our highly-rated and maintenance-free CAGE CLAMP® connection makes it easy to connect all conductor types without having to prepare the conductor. For example, you don't need to crimp ferrules. Dimensions: (46 x 17.5 x 27.5) mm (width x height x depth). This male connector is suitable for conductor cross sections ranging from 0.08 mm<sup>2</sup> to 2.5 mm<sup>2</sup>.

Tin is used for coating the contact surfaces.

## Notes

## Safety Information

The MCS – MULTI CONNECTION SYSTEM includes connectors without breaking capacity in accordance with DIN EN 61984. When used as intended, these connectors must not be connected/disconnected when live or under load. When used as intended, these connectors must not be connected/disconnected when live or under load. The circuit design should ensure header pins, which can be touched, are not live when unmated.

## Variants:

Other pole numbers  
Gold-plated or partially gold-plated contact surfaces  
Other versions (or variants) can be requested from WAGO Sales or configured at <https://configurator.wago.com/>.

## Electrical data

Ratings per		IEC/EN 60664-1			Approvals per		UL 1059		
Overvoltage category		III	III	II	Use group	B	C	D	
Pollution degree		3	2	2	Rated voltage	300 V	-	300 V	
Nominal voltage		320 V	320 V	630 V	Rated current	15 A	-	10 A	
Rated impulse withstand voltage		4 kV	4 kV	4 kV					
Rated current		12 A	12 A	12 A					

Approvals per		UL 1977			Approvals per		CSA		
Rated voltage		600 V			Use group	B	C	D	
Rated current		15 A			Rated voltage	300 V	-	300 V	
					Rated current	15 A	-	10 A	

## Connection Data

Clamping units	5	<b>Connection 1</b>	
Total number of potentials	5	Connection technology	CAGE CLAMP®
Number of connection types	1	Actuation type	Operating tool
Number of levels	1	Actuation direction 1	Operation parallel to conductor entry
		Actuation direction 2	Operation perpendicular to conductor entry
		Solid conductor	0.08 ... 2.5 mm <sup>2</sup> / 28 ... 12 AWG
		Fine-stranded conductor	0.08 ... 2.5 mm <sup>2</sup> / 28 ... 12 AWG
		Fine-stranded conductor; with insulated ferrule	0.25 ... 1.5 mm <sup>2</sup>
		Fine-stranded conductor; with uninsulated ferrule	0.25 ... 2.5 mm <sup>2</sup>
		Strip length	8 ... 9 mm / 0.31 ... 0.35 inches
		Pole number	5
		Conductor entry direction to mating direction	0°

## Physical data

Pin spacing	5 mm / 0.197 inches
Width	46 mm / 1.811 inches
Height	17.5 mm / 0.689 inches
Depth	27.5 mm / 1.083 inches

### Mechanical data

Variable coding	Yes
Housing sheet thickness	0.5 ... 2.5 mm / 0.02 ... 0.098 inches
Mounting type	Snap-in flange
Mounting type	Feed-through mounting
Anti-rotation protection	Yes
Suitable for through-panel applications	Yes

### Plug-in connection

Contact type (pluggable connector)	Male connector/plug
Connector (connection type)	for conductor
Mismating protection	Yes

### Material data

Note (material data)	<a href="#">Information on material specifications can be found here</a>
Color	light gray
Material group	I
Insulation material (main housing)	Polyamide (PA66)
Flammability class per UL94	V0
Clamping spring material	Chrome-nickel spring steel (CrNi)
Contact material	Electrolytic copper (E <sub>Cu</sub> )
Contact Plating	Tin
Fire load	0.207 MJ
Weight	10.1 g

### Environmental requirements

Limit temperature range	-60 ... +100 °C
Processing temperature	-35 ... +60 °C

### Commercial data

PU (SPU)	50 pcs
Packaging type	Box
Country of origin	DE
GTIN	4050821399025
Customs tariff number	85366930000

### Product Classification

UNSPSC	39121409
eCl@ss 10.0	27-44-03-09
eCl@ss 9.0	27-44-03-09
ETIM 9.0	EC002638
ETIM 10.0	EC002638
ECCN	NO US CLASSIFICATION

**Environmental Product Compliance**

RoHS Compliance Status	Compliant, No Exemption
------------------------	-------------------------

**Approvals / Certificates**

**General approvals**



Approval	Standard	Certificate Name
CSA CSA Group	C22.2	1466354
UL Underwriters Laboratories Inc.	UL 1977	E45171
UL Underwriters Laboratories Inc.	UL 1059	E45172

**Downloads**

**Environmental Product Compliance**

Compliance Search	
Environmental Product Compliance 721-605/114-040	<a href="#">↓</a>

**Documentation**

Additional Information			
Technical Section	03.04.2019	pdf 2027.26 KB	<a href="#">↓</a>

**1 Compatible Products**

**1.1 System counterpart**

**1.1.1 Female connector/socket**



**Item No.: 721-105/026-000**  
 1-conductor female connector; CAGE CLAMP®; 2.5 mm²; Pin spacing 5 mm; 5-pole; 100% protected against mismatching; 2,50 mm²; light gray

1.2 Optional Accessories

1.2.1 Coding

1.2.1.1 Coding



**Item No.: 231-129**

Coding key; snap-on type; light gray

1.2.2 Cover

1.2.2.1 Cover



**Item No.: 231-668**

Lockout caps; for covering unused clamping units; gray

1.2.3 Ferrule

1.2.3.1 Ferrule



**Item No.: 216-301**

Ferrule; Sleeve for 0.25 mm<sup>2</sup> / AWG 24; insulated; electro-tin plated; yellow



**Item No.: 216-302**

Ferrule; Sleeve for 0.34 mm<sup>2</sup> / 22 AWG; insulated; electro-tin plated; light turquoise



**Item No.: 216-201**

Ferrule; Sleeve for 0.5 mm<sup>2</sup> / 20 AWG; insulated; electro-tin plated; electrolytic copper; acc. to DIN 46228, Part 4/09.90; white



**Item No.: 216-241**

Ferrule; Sleeve for 0.5 mm<sup>2</sup> / 20 AWG; insulated; electro-tin plated; electrolytic copper; gastight crimped; acc. to DIN 46228, Part 4/09.90; white



**Item No.: 216-141**

Ferrule; Sleeve for 0.5 mm<sup>2</sup> / 20 AWG; un-insulated; electro-tin plated; electrolytic copper; gastight crimped; acc. to DIN 46228, Part 1/08.92



**Item No.: 216-101**

Ferrule; Sleeve for 0.5 mm<sup>2</sup> / AWG 22; un-insulated; electro-tin plated; silver-colored



**Item No.: 216-242**

Ferrule; Sleeve for 0.75 mm<sup>2</sup> / 18 AWG; insulated; electro-tin plated; electrolytic copper; gastight crimped; acc. to DIN 46228, Part 4/09.90; gray



**Item No.: 216-262**

Ferrule; Sleeve for 0.75 mm<sup>2</sup> / 18 AWG; insulated; electro-tin plated; electrolytic copper; gastight crimped; acc. to DIN 46228, Part 4/09.90; gray



**Item No.: 216-202**

Ferrule; Sleeve for 0.75 mm<sup>2</sup> / 18 AWG; insulated; electro-tin plated; gray



**Item No.: 216-142**

Ferrule; Sleeve for 0.75 mm<sup>2</sup> / 18 AWG; un-insulated; electro-tin plated; electrolytic copper; gastight crimped; acc. to DIN 46228, Part 1/08.92



**Item No.: 216-102**

Ferrule; Sleeve for 0.75 mm<sup>2</sup> / AWG 20; un-insulated; electro-tin plated; silver-colored



**Item No.: 216-243**

Ferrule; Sleeve for 1 mm<sup>2</sup> / AWG 18; insulated; electro-tin plated; electrolytic copper; gastight crimped; acc. to DIN 46228, Part 4/09.90; red



**Item No.: 216-263**

Ferrule; Sleeve for 1 mm<sup>2</sup> / AWG 18; insulated; electro-tin plated; electrolytic copper; gastight crimped; acc. to DIN 46228, Part 4/09.90; red



**Item No.: 216-203**

Ferrule; Sleeve for 1 mm<sup>2</sup> / AWG 18; insulated; electro-tin plated; red



**Item No.: 216-103**

Ferrule; Sleeve for 1 mm<sup>2</sup> / AWG 18; un-insulated; electro-tin plated



**Item No.: 216-143**

Ferrule; Sleeve for 1 mm<sup>2</sup> / AWG 18; un-insulated; electro-tin plated; electrolytic copper; gastight crimped; acc. to DIN 46228, Part 1/08.92



**Item No.: 216-204**

Ferrule; Sleeve for 1.5 mm<sup>2</sup> / AWG 16; insulated; electro-tin plated; black



**Item No.: 216-244**

Ferrule; Sleeve for 1.5 mm<sup>2</sup> / AWG 16; insulated; electro-tin plated; electrolytic copper; gastight crimped; acc. to DIN 46228, Part 4/09.90; black



**Item No.: 216-264**

Ferrule; Sleeve for 1.5 mm<sup>2</sup> / AWG 16; insulated; electro-tin plated; electrolytic copper; gastight crimped; acc. to DIN 46228, Part 4/09.90; black



**Item No.: 216-284**

Ferrule; Sleeve for 1.5 mm<sup>2</sup> / AWG 16; insulated; electro-tin plated; electrolytic copper; gastight crimped; acc. to DIN 46228, Part 4/09.90; black



**Item No.: 216-144**

Ferrule; Sleeve for 1.5 mm<sup>2</sup> / AWG 16; un-insulated; electro-tin plated; electrolytic copper; gastight crimped; acc. to DIN 46228, Part 1/08.92; silver-colored



**Item No.: 216-104**

Ferrule; Sleeve for 1.5 mm<sup>2</sup> / AWG 16; un-insulated; electro-tin plated; silver-colored



**Item No.: 216-106**

Ferrule; Sleeve for 2.5 mm<sup>2</sup> / AWG 14; un-insulated; electro-tin plated; silver-colored

## 1.2.4 Insulation stop

### 1.2.4.1 Insulation stop



**Item No.: 231-670**

Insulation stop; 0.08-0.2 mm² / 0.2 mm² "s"; white



**Item No.: 231-671**

Insulation stop; 0.25 - 0.5 mm²; light gray



**Item No.: 231-672**

Insulation stop; 0.75 - 1 mm²; dark gray

## 1.2.5 Jumper

### 1.2.5.1 Jumper



**Item No.: 231-902**

Jumper; for conductor entry; 2-way; insulated; gray



**Item No.: 231-903**

Jumper; for conductor entry; 3-way; insulated; gray



**Item No.: 231-905**

Jumper; for conductor entry; 5-way; insulated; gray

## 1.2.6 Strain relief

### 1.2.6.1 Strain relief housing



**Item No.: 232-605**

Strain relief housing; for female and male connectors; 2 parts; Pin spacing 5 mm; 5-pole; gray

## 1.2.7 Tool

### 1.2.7.1 Operating tool



**Item No.: 231-231**

Combination operating tool; red



**Item No.: 210-720**

Operating tool; Blade: 3.5 x 0.5 mm; with a partially insulated shaft; multicoloured



**Item No.: 210-657**

Operating tool; Blade: 3.5 x 0.5 mm; with a partially insulated shaft; short; multicoloured



**Item No.: 209-130**

Operating tool; made of insulating material; 1-way; for 264 Series (1-/2-way), 280, 281 Series (up to 3-way); natural



**Item No.: 231-291**

Operating tool; made of insulating material; 1-way; loose; red



**Item No.: 231-131**

Operating tool; made of insulating material; 1-way; loose; white



**Item No.: 280-432**

Operating tool; made of insulating material; 2-way; white



**Item No.: 280-433**

Operating tool; made of insulating material; 3-way; white



**Item No.: 280-434**

Operating tool; made of insulating material; 4-way; white



**Item No.: 280-435**

Operating tool; made of insulating material; 5-way; gray



**Item No.: 231-159**

Operating tool; natural

## Installation Notes

### Conductor termination

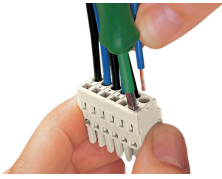

Inserting a conductor via 3.5 mm screwdriver – CAGE CLAMP® actuation parallel to conductor entry.

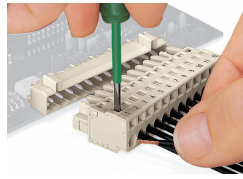

Inserting a conductor via 3.5 mm screwdriver – CAGE CLAMP® actuation perpendicular to conductor entry.

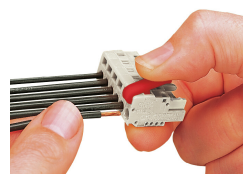

Inserting a conductor via operating tool.

### Testing

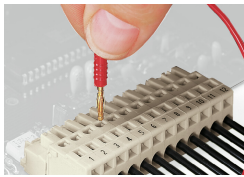

Testing perpendicular to conductor entry with 2 or 2.3 mm Ø test plug – female connector with CAGE CLAMP® – via integrated test ports

### Installation



Male connector with strain relief plate



Strain relief housing shown with a male connector equipped with CAGE CLAMP®

### Coding

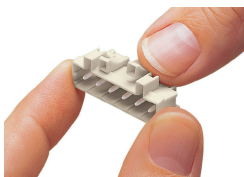

Coding a male header – fitting coding key (s).